

DATA SHEET

74F132

Quad 2-input NAND Schmitt trigger

Product specification

1991 Jun 26

IC15 Data Handbook

Quad 2-input NAND Schmitt trigger

74F132

DESCRIPTION

The 74F132 contains four 2-input NAND gates which accept standard TTL input signals and provide standard TTL output levels. They are capable of transforming slowly changing input signals into sharply defined, jitter-free output signals. In addition, they have greater noise margin than conventional NAND gates. Each circuit contains a 2-input Schmitt trigger followed by a Darlington level shifter and a phase splitter driving a TTL totem-pole output. The Schmitt trigger uses positive feedback to effectively speed-up slow input transitions and provide different input threshold voltages for positive and negative-going transitions. This hysteresis between the positive-going and negative-going input threshold (typically 800mV) is determined by resistor ratios and is essentially insensitive to temperature and supply voltage variations. As long as three inputs remain at a more positive voltage than V_{T+MAX} , the gate will respond in the transition of the other input as shown in Waveform 1.

PIN CONFIGURATION

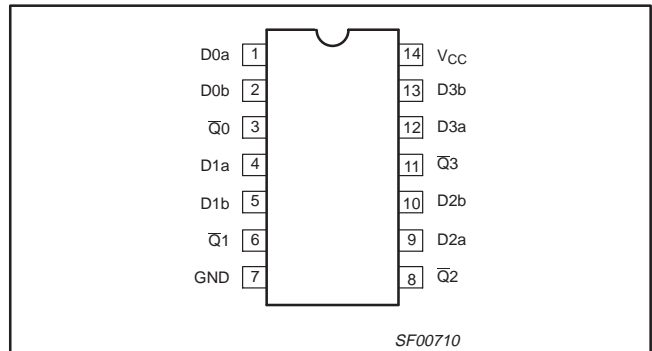

TYPE	TYPICAL PROPAGATION DELAY	TYPICAL SUPPLY CURRENT (TOTAL)
74F132	6.3ns	13mA

ORDERING INFORMATION

DESCRIPTION	COMMERCIAL RANGE $V_{CC} = 5V \pm 10\%$, $T_{amb} = 0^{\circ}C$ to $+70^{\circ}C$	PKG DWG #
14-pin plastic DIP	N74F132N	SOT27-1
14-pin plastic SO	N74F132D	SOT108-1

INPUT AND OUTPUT LOADING AND FAN-OUT TABLE

PINS	DESCRIPTION	74F (U.L.) HIGH/LOW	LOAD VALUE HIGH/LOW
Dna, Dnb	Data inputs	1.0/1.0	20µA/0.6mA
\bar{Q}_n	Data output	50/33	1.0mA/20mA

NOTE: One (1.0) FAST unit load is defined as: 20µA in the High state and 0.6mA in the Low state.

LOGIC SYMBOL

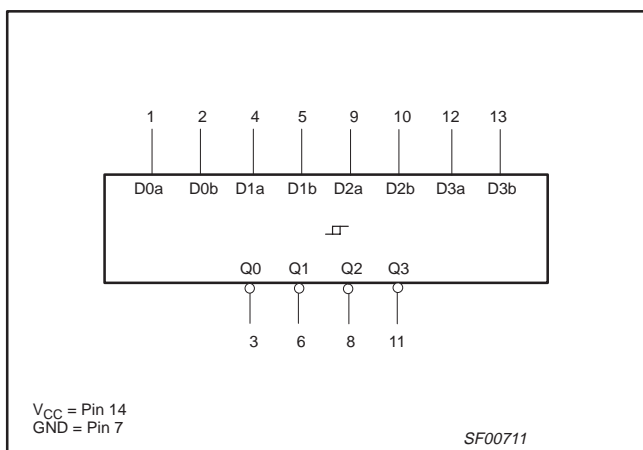

IEC/IEEE SYMBOL

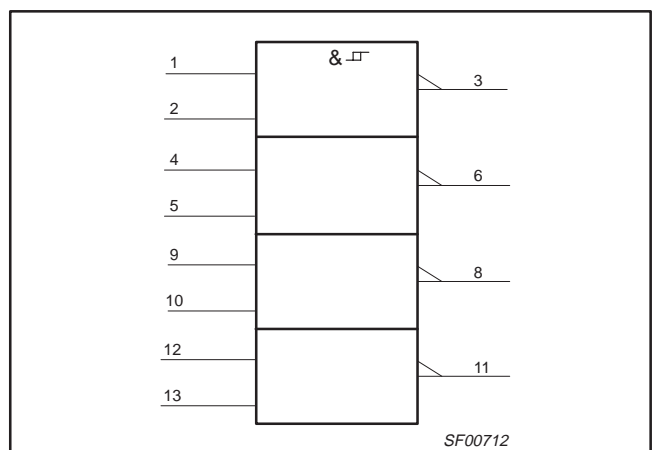

Quad 2-input NAND Schmitt trigger

74F132

LOGIC DIAGRAM

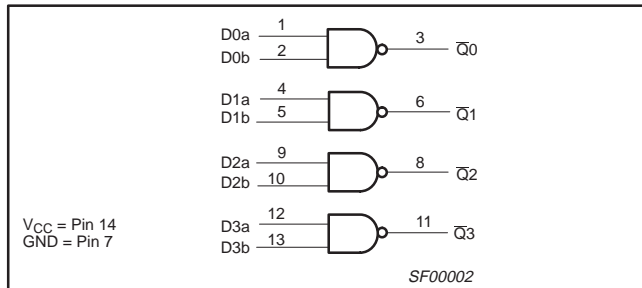

FUNCTION TABLE

INPUTS		OUTPUT
D _{na}	D _{nb}	Q _n
L	L	H
L	H	H
H	L	H
H	H	L

NOTES:

H = High voltage level
L = Low voltage level

ABSOLUTE MAXIMUM RATINGS

(Operation beyond the limits set forth in this table may impair the useful life of the device. Unless otherwise noted these limits are over the operating free-air temperature range.)

SYMBOL	PARAMETER	RATING	UNIT
V _{CC}	Supply voltage	-0.5 to +7.0	V
V _{IN}	Input voltage	-0.5 to +7.0	V
I _{IN}	Input current	-30 to +5	mA
V _{OUT}	Voltage applied to output in High output state	-0.5 to V _{CC}	V
I _{OUT}	Current applied to output in Low output state	40	mA
T _{amb}	Operating free-air temperature range	0 to +70	°C
T _{stg}	Storage temperature	-65 to +150	°C

RECOMMENDED OPERATING CONDITIONS

SYMBOL	PARAMETER	LIMITS			UNIT
		MIN	NOM	MAX	
V _{CC}	Supply voltage	4.5	5.0	5.5	V
I _{IK}	Input clamp current			-18	mA
I _{OH}	High-level output current			-1	mA
I _{OL}	Low-level output current			20	mA
T _{amb}	Operating free-air temperature range	0		+70	°C

Quad 2-input NAND Schmitt trigger

74F132

DC ELECTRICAL CHARACTERISTICS

(Over recommended operating free-air temperature range unless otherwise noted.)

SYMBOL	PARAMETER	TEST CONDITIONS ¹	LIMITS			UNIT	
			MIN	TYP ²	MAX		
V_{T+}	Positive-going threshold	$V_{CC} = 5.0V$	1.5	1.7	2.0	V	
V_{T-}	Negative-going threshold	$V_{CC} = 5.0V$	0.7	0.9	1.1	V	
ΔV_T	Hysteresis ($V_{T+} - V_{T-}$)	$V_{CC} = 5.0V$	0.4	0.8		V	
V_{OH}	High-level output voltage	$V_{CC} = \text{MIN},$ $V_I = V_{T-\text{MAX}}, I_{OH} = \text{MAX}$	$\pm 10\%V_{CC}$	2.5		V	
			$\pm 5\%V_{CC}$	2.7	3.4		
V_{OL}	Low-level output voltage	$V_{CC} = \text{MIN},$ $V_I = V_{T+\text{MAX}}, I_{OL} = \text{MAX}$	$\pm 10\%V_{CC}$		0.30	0.50	V
			$\pm 5\%V_{CC}$		0.30	0.50	
V_{IK}	Input clamp voltage	$V_{CC} = \text{MIN}, I_I = I_{IK}$		-0.73	-1.2	V	
I_{T+}	Input current at positive-going threshold	$V_{CC} = 5.0V, V_I = V_{T+}$		0		μA	
I_{T-}	Input current at negative-going threshold	$V_{CC} = 5.0V, V_I = V_{T-}$		-350		μA	
I_I	Input current at maximum input voltage	$V_{CC} = \text{MAX}, V_I = 7.0V$			100	μA	
I_{IH}	High-level input current	$V_{CC} = \text{MAX}, V_I = 2.7V$			20	μA	
I_{IL}	Low-level input current	$V_{CC} = \text{MAX}, V_I = 0.5V$			-0.6	mA	
I_{OS}	Short-circuit output current ³	$V_{CC} = \text{MAX}$	-60		-150	mA	
I_{CC}	Supply current (total)	$V_{CC} = \text{MAX}$	$V_{IN} = \text{GND}$		8.5	12.0	mA
				$V_{IN} = 4.5V$		13.0	

NOTES:

- For conditions shown as MIN or MAX, use the appropriate value specified under recommended operating conditions for the applicable type.
- All typical values are at $V_{CC} = 5V, T_{amb} = 25^\circ C$.
- Not more than one output should be shorted at a time. For testing I_{OS} , the use of high-speed test apparatus and/or sample-and-hold techniques are preferable in order to minimize internal heating and more accurately reflect operational values. Otherwise, prolonged shorting of a High output may raise the chip temperature well above normal and thereby cause invalid readings in other parameter tests. In any sequence of parameter tests, I_{OS} tests should be performed last.

Quad 2-input NAND Schmitt trigger

74F132

AC ELECTRICAL CHARACTERISTICS

SYMBOL	PARAMETER	TEST CONDITION	LIMITS					UNIT
			$V_{CC} = +5.0V$ $T_{amb} = +25^{\circ}C$ $C_L = 50pF, R_L = 500\Omega$			$V_{CC} = +5.0V \pm 10\%$ $T_{amb} = 0^{\circ}C \text{ to } +70^{\circ}C$ $C_L = 50pF, R_L = 500\Omega$		
			MIN	TYP	MAX	MIN	MAX	
t_{PLH} t_{PHL}	Propagation delay Dna, Dnb to \bar{Q}_n	Waveform 1	3.5 4.5	5.5 6.0	7.0 8.5	3.0 4.5	8.5 9.0	ns

AC WAVEFORMS

For all waveforms, $V_M = 1.5V$.

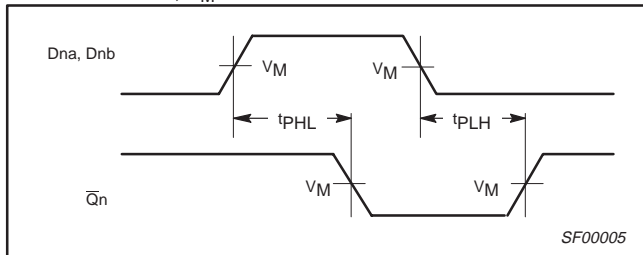

Waveform 1. For Inverting Outputs

TEST CIRCUIT AND WAVEFORMS

Test Circuit for Totem-Pole Outputs

Input Pulse Definition

DEFINITIONS:
 R_L = Load resistor; see AC ELECTRICAL CHARACTERISTICS for value.
 C_L = Load capacitance includes jig and probe capacitance; see AC ELECTRICAL CHARACTERISTICS for value.
 R_T = Termination resistance should be equal to Z_{OUT} of pulse generators.

family	INPUT PULSE REQUIREMENTS					
	amplitude	V_M	rep. rate	t_w	t_{TLH}	t_{THL}
74F	3.0V	1.5V	1MHz	500ns	2.5ns	2.5ns

SF00006

Quad 2-input NAND Schmitt trigger

74F132

DIP14: plastic dual in-line package; 14 leads (300 mil)

SOT27-1

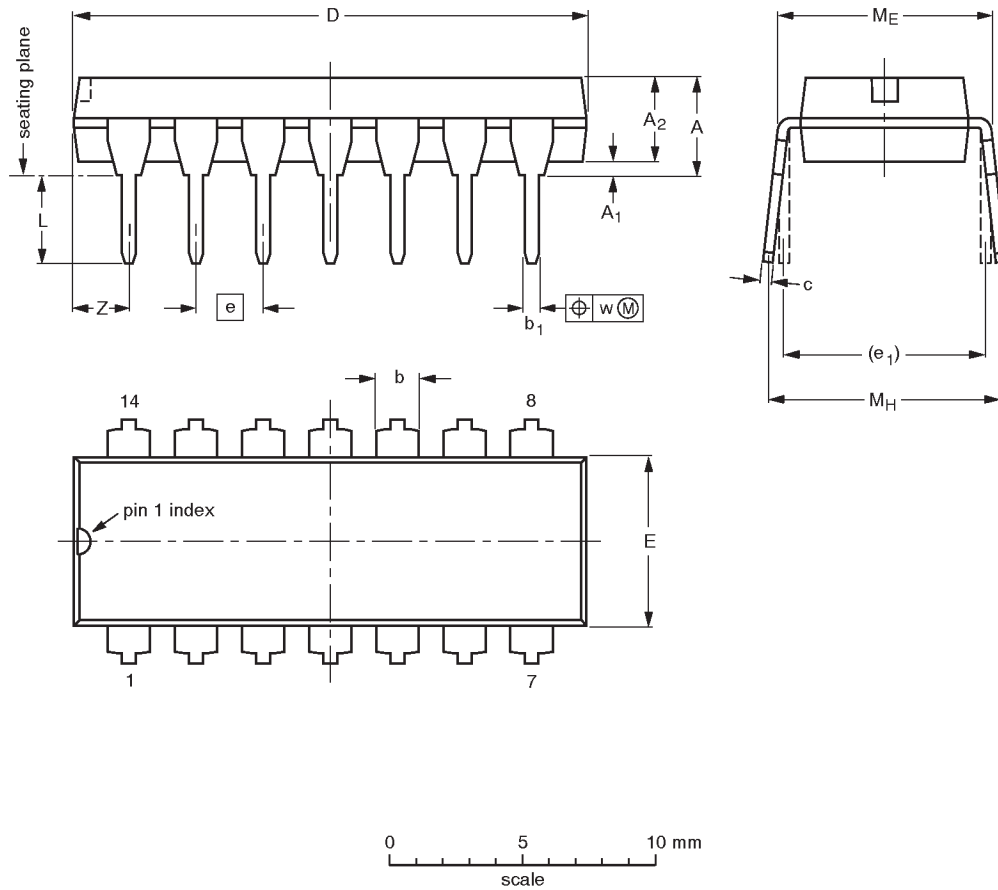

DIMENSIONS (inch dimensions are derived from the original mm dimensions)

UNIT	A max.	A ₁ min.	A ₂ max.	b	b ₁	c	D ⁽¹⁾	E ⁽¹⁾	e	e ₁	L	M _E	M _H	w	Z ⁽¹⁾ max.
mm	4.2	0.51	3.2	1.73 1.13	0.53 0.38	0.36 0.23	19.50 18.55	6.48 6.20	2.54	7.62	3.60 3.05	8.25 7.80	10.0 8.3	0.254	2.2
inches	0.17	0.020	0.13	0.068 0.044	0.021 0.015	0.014 0.009	0.77 0.73	0.26 0.24	0.10	0.30	0.14 0.12	0.32 0.31	0.39 0.33	0.01	0.087

Note

1. Plastic or metal protrusions of 0.25 mm maximum per side are not included.

OUTLINE VERSION	REFERENCES			EUROPEAN PROJECTION	ISSUE DATE
	IEC	JEDEC	EIAJ		
SOT27-1	050G04	MO-001AA			92-11-17 95-03-11

Quad 2-input NAND Schmitt trigger

74F132

SO14: plastic small outline package; 14 leads; body width 3.9 mm

SOT108-1

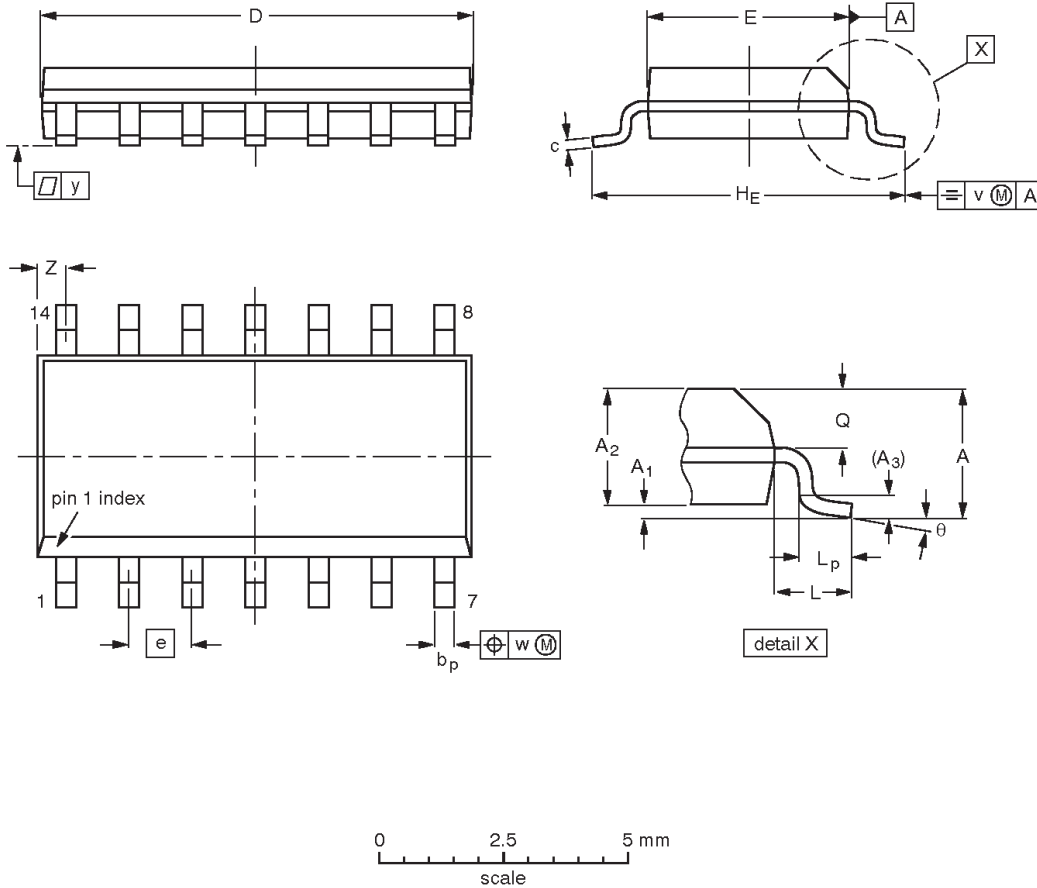

DIMENSIONS (inch dimensions are derived from the original mm dimensions)

UNIT	A max.	A ₁	A ₂	A ₃	b _p	c	D ⁽¹⁾	E ⁽¹⁾	e	H _E	L	L _p	Q	v	w	y	z ⁽¹⁾	θ
mm	1.75	0.25 0.10	1.45 1.25	0.25	0.49 0.36	0.25 0.19	8.75 8.55	4.0 3.8	1.27	6.2 5.8	1.05	1.0 0.4	0.7 0.6	0.25	0.25	0.1	0.7 0.3	8° 0°
inches	0.069	0.010 0.004	0.057 0.049	0.01	0.019 0.014	0.0100 0.0075	0.35 0.34	0.16 0.15	0.050	0.244 0.228	0.041	0.039 0.016	0.028 0.024	0.01	0.01	0.004	0.028 0.012	

Note

1. Plastic or metal protrusions of 0.15 mm maximum per side are not included.

OUTLINE VERSION	REFERENCES			EUROPEAN PROJECTION	ISSUE DATE
	IEC	JEDEC	EIAJ		
SOT108-1	076E06S	MS-012AB			95-01-29 97-05-22

Quad 2-input NAND Schmitt trigger

74F132

Data sheet status

Data sheet status	Product status	Definition [1]
Objective specification	Development	This data sheet contains the design target or goal specifications for product development. Specification may change in any manner without notice.
Preliminary specification	Qualification	This data sheet contains preliminary data, and supplementary data will be published at a later date. Philips Semiconductors reserves the right to make changes at any time without notice in order to improve design and supply the best possible product.
Product specification	Production	This data sheet contains final specifications. Philips Semiconductors reserves the right to make changes at any time without notice in order to improve design and supply the best possible product.

[1] Please consult the most recently issued datasheet before initiating or completing a design.

Definitions

Short-form specification — The data in a short-form specification is extracted from a full data sheet with the same type number and title. For detailed information see the relevant data sheet or data handbook.

Limiting values definition — Limiting values given are in accordance with the Absolute Maximum Rating System (IEC 134). Stress above one or more of the limiting values may cause permanent damage to the device. These are stress ratings only and operation of the device at these or at any other conditions above those given in the Characteristics sections of the specification is not implied. Exposure to limiting values for extended periods may affect device reliability.

Application information — Applications that are described herein for any of these products are for illustrative purposes only. Philips Semiconductors make no representation or warranty that such applications will be suitable for the specified use without further testing or modification.

Disclaimers

Life support — These products are not designed for use in life support appliances, devices or systems where malfunction of these products can reasonably be expected to result in personal injury. Philips Semiconductors customers using or selling these products for use in such applications do so at their own risk and agree to fully indemnify Philips Semiconductors for any damages resulting from such application.

Right to make changes — Philips Semiconductors reserves the right to make changes, without notice, in the products, including circuits, standard cells, and/or software, described or contained herein in order to improve design and/or performance. Philips Semiconductors assumes no responsibility or liability for the use of any of these products, conveys no license or title under any patent, copyright, or mask work right to these products, and makes no representations or warranties that these products are free from patent, copyright, or mask work right infringement, unless otherwise specified.

Philips Semiconductors
811 East Arques Avenue
P.O. Box 3409
Sunnyvale, California 94088-3409
Telephone 800-234-7381

© Copyright Philips Electronics North America Corporation 1998
All rights reserved. Printed in U.S.A.

print code

Date of release: 10-98

Document order number:

9397-750-05074

Let's make things better.