



**GM Series  
Evaluation Module  
User's Guide**

**Wireless made simple<sup>®</sup>**

**Warning:** Some customers may want Linx radio frequency (“RF”) products to control machinery or devices remotely, including machinery or devices that can cause death, bodily injuries, and/or property damage if improperly or inadvertently triggered, particularly in industrial settings or other applications implicating life-safety concerns (“Life and Property Safety Situations”).

**NO OEM LINX REMOTE CONTROL OR FUNCTION MODULE SHOULD EVER BE USED IN LIFE AND PROPERTY SAFETY SITUATIONS.** No OEM Linx Remote Control or Function Module should be modified for Life and Property Safety Situations. Such modification cannot provide sufficient safety and will void the product’s regulatory certification and warranty.

Customers may use our (non-Function) Modules, Antenna and Connectors as part of other systems in Life Safety Situations, but only with necessary and industry appropriate redundancies and in compliance with applicable safety standards, including without limitation, ANSI and NFPA standards. It is solely the responsibility of any Linx customer who uses one or more of these products to incorporate appropriate redundancies and safety standards for the Life and Property Safety Situation application.

**Do not use this or any Linx product to trigger an action directly from the data line or RSSI lines without a protocol or encoder/decoder to validate the data.** Without validation, any signal from another unrelated transmitter in the environment received by the module could inadvertently trigger the action.

**All RF products are susceptible to RF interference that can prevent communication.** RF products without frequency agility or hopping implemented are more subject to interference. This module does not have a frequency hopping protocol built in.

**Do not use any Linx product over the limits in this data guide.** Excessive voltage or extended operation at the maximum voltage could cause product failure. Exceeding the reflow temperature profile could cause product failure which is not immediately evident.

**Do not make any physical or electrical modifications to any Linx product.** This will void the warranty and regulatory and UL certifications and may cause product failure which is not immediately evident.

# Table of Contents

- 1 [Description](#)
- 2 [Ordering Information](#)
- 2 [Electrical Specifications](#)
- 3 [Pin Assignments](#)
- 3 [PCB Layout](#)
- 3 [Schematic](#)

# GM Series GNSS Receiver Evaluation Module User's Guide

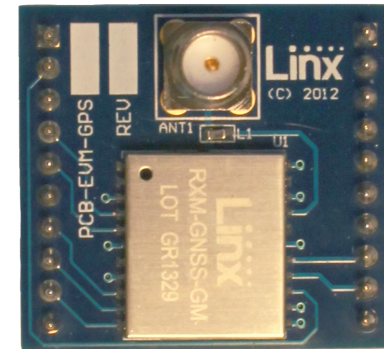

Figure 1: GM Series Evaluation Module

## Description

The GM Series GNSS receiver module is a self-contained high-performance Global Satellite Navigation System receiver. Based on the MediaTek chipset, it can simultaneously acquire and track multiple satellite constellations. These include the United States GPS system, Europe's GALILEO, Russia's GLONASS and Japan's QZSS.

The module provides exceptional sensitivity, even in dense foliage and urban canyons. It's very low power consumption helps maximize runtimes in battery powered applications. Hybrid ephemeris prediction can be used to achieve cold start times of less than 15 seconds. The module outputs standard NMEA data.

The evaluation module contains the surface mount GM Series GNSS module, SMA connector and a ferrite bead (used to supply power to an external active antenna, such as the LinX SH Series active GPS antenna) on a single board with through-hole headers. This small board makes prototyping with the GM Series module very easy.

## Ordering Information

Ordering Information	
Part Number	Description
EVM-GNSS-GM	GM Series Evaluation Module
RXM-GNSS-GM	GM Series GNSS Receiver Module
MDEV-GNSS-GM	GM Series GNSS Receiver Master Development System

Figure 2: Ordering Information

## Electrical Specifications

GM Series GNSS Receiver Specifications						
Parameter	Symbol	Min.	Typ.	Max.	Units	Notes
Power Supply						
Operating Voltage	$V_{CC}$	3.0	3.3	4.3	VDC	
Supply Current	$I_{CC}$					
Peak				150	mA	1
Acquisition			24		mA	1
Tracking			16		mA	1
Standby			0.365		mA	1
Backup Battery Voltage	$V_{BAT}$	2.0		4.3	VDC	
Backup Battery Current	$I_{BAT}$		7		$\mu$ A	2
Antenna Port						
RF Impedance	$R_{IN}$		50		$\Omega$	
Environmental						
Operating Temperature Range		-40		+85	$^{\circ}$ C	
Storage Temperature Range		-40		+85	$^{\circ}$ C	
1. $V_{CC} = 3.3V$ , without active antenna, ephemeris prediction is off 2. $V_{CC} = 0V$						

Figure 3: Electrical Specifications

## Pin Assignments

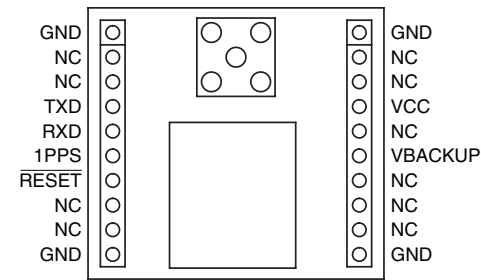

Figure 4: EVM-GNSS-GM Pin Assignments

## PCB Layout

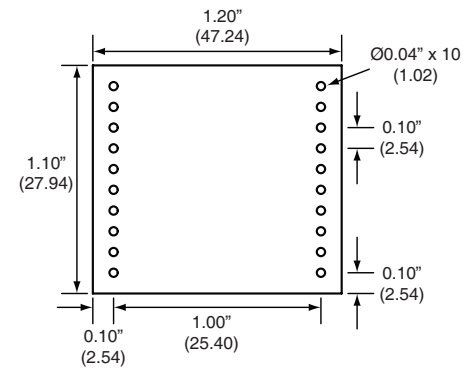

Figure 5: EVM-GNSS-GM PCB Layout Dimensions

## Schematic

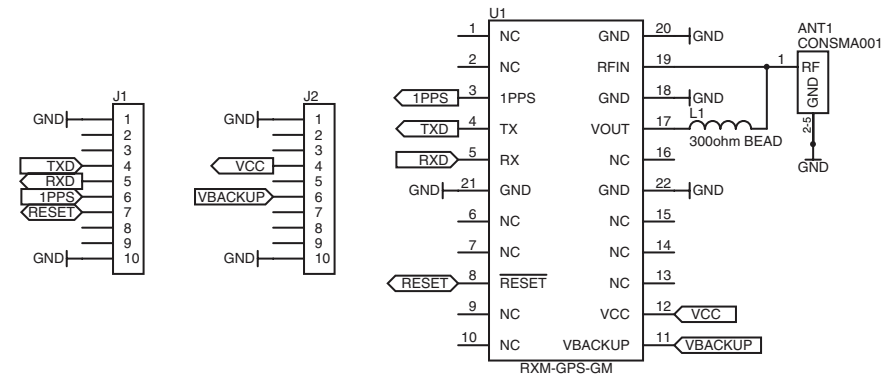

Figure 6: EVM-GNSS-GM Schematic

**Warning:** This product incorporates numerous static-sensitive components. Always wear an ESD wrist strap and observe proper ESD handling procedures when working with this device. Failure to observe this precaution may result in module damage or failure.



Linx Technologies  
159 Ort Lane  
Merlin, OR, US 97532

Phone: +1 541 471 6256  
Fax: +1 541 471 6251

[www.linxtechnologies.com](http://www.linxtechnologies.com)

---

#### Disclaimer

Linx Technologies is continually striving to improve the quality and function of its products. For this reason, we reserve the right to make changes to our products without notice. The information contained in this Data Guide is believed to be accurate as of the time of publication. Specifications are based on representative lot samples. Values may vary from lot-to-lot and are not guaranteed. "Typical" parameters can and do vary over lots and application. Linx Technologies makes no guarantee, warranty, or representation regarding the suitability of any product for use in any specific application. It is the customer's responsibility to verify the suitability of the part for the intended application. **NO LINX PRODUCT IS INTENDED FOR USE IN ANY APPLICATION WHERE THE SAFETY OF LIFE OR PROPERTY IS AT RISK.**

Linx Technologies **DISCLAIMS ALL WARRANTIES OF MERCHANTABILITY AND FITNESS FOR A PARTICULAR PURPOSE. IN NO EVENT SHALL LINX TECHNOLOGIES BE LIABLE FOR ANY OF CUSTOMER'S INCIDENTAL OR CONSEQUENTIAL DAMAGES ARISING IN ANY WAY FROM ANY DEFECTIVE OR NON-CONFORMING PRODUCTS OR FOR ANY OTHER BREACH OF CONTRACT BY LINX TECHNOLOGIES.** The limitations on Linx Technologies' liability are applicable to any and all claims or theories of recovery asserted by Customer, including, without limitation, breach of contract, breach of warranty, strict liability, or negligence. Customer assumes all liability (including, without limitation, liability for injury to person or property, economic loss, or business interruption) for all claims, including claims from third parties, arising from the use of the Products. The Customer will indemnify, defend, protect, and hold harmless Linx Technologies and its officers, employees, subsidiaries, affiliates, distributors, and representatives from and against all claims, damages, actions, suits, proceedings, demands, assessments, adjustments, costs, and expenses incurred by Linx Technologies as a result of or arising from any Products sold by Linx Technologies to Customer. Under no conditions will Linx Technologies be responsible for losses arising from the use or failure of the device in any application, other than the repair, replacement, or refund limited to the original product purchase price. Devices described in this publication may contain proprietary, patented, or copyrighted techniques, components, or materials. Under no circumstances shall any user be conveyed any license or right to the use or ownership of such items.

---

©2015 Linx Technologies. All rights reserved.

The stylized Linx logo, Wireless Made Simple, WISE, CipherLinx and the stylized CL logo are trademarks of Linx Technologies.