

PRODUCT NO.
10067847-3XXXXLF

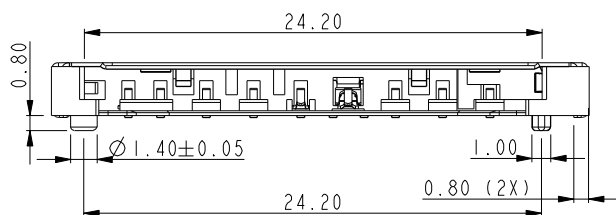

rev	ecn no	dr	date
A	DG09-0387	BL	12-14-09

www.fciconnect.com		surface - ✓	tolerance std ASME Y14.5	projection	MM
TOLERANCES UNLESS OTHERWISE SPECIFIED		ANGULAR	LINEAR	size A4	Scale 1.000
Dr	LEIF SHEN	05-18-06	0° ±2°	0.X ±0.30	ECN DG09-0387
Eng	LEIF SHEN	05-18-06	0.XX ±0.20	0.XXX ±0.10	Spec ref RELEASED
Chr	PAUL WANG	05-18-06	Product family	SD	
Appr	JOSEPH HSIA	05-18-06			
FCI		title ASSEMBLY		dwg no	10067847-301
		SD CARD READER			Rev. A
		catalog no	10067847	CUSTOMER	sheet 1 of 3

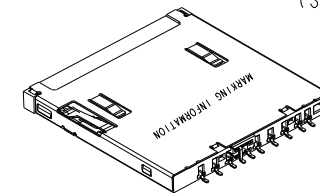
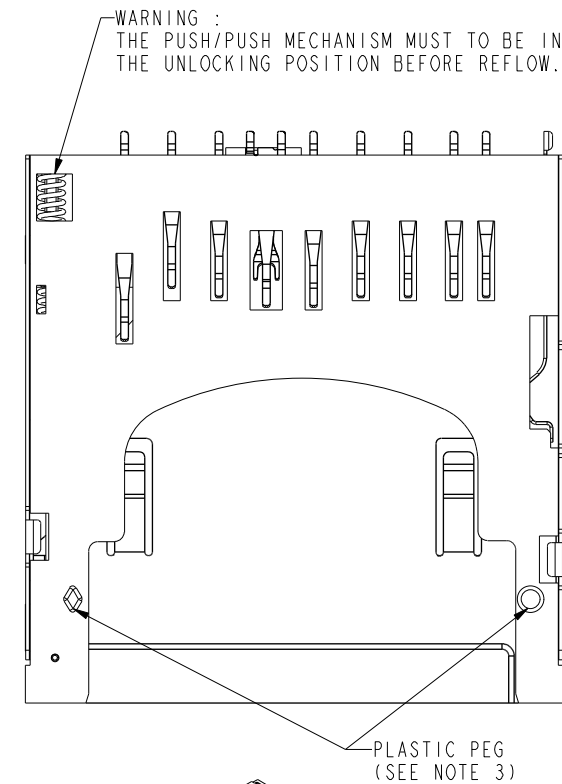
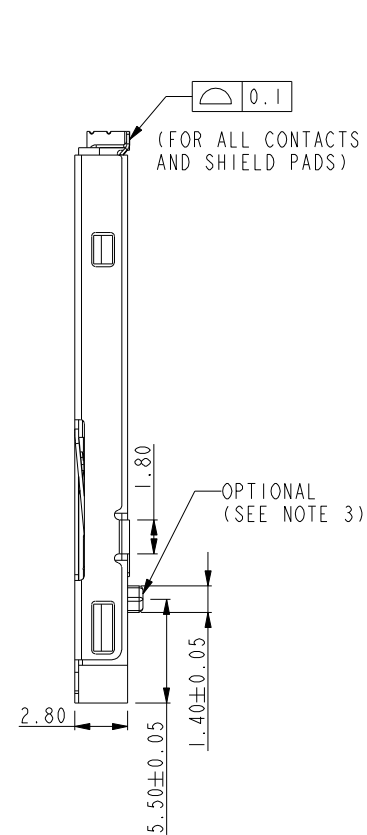
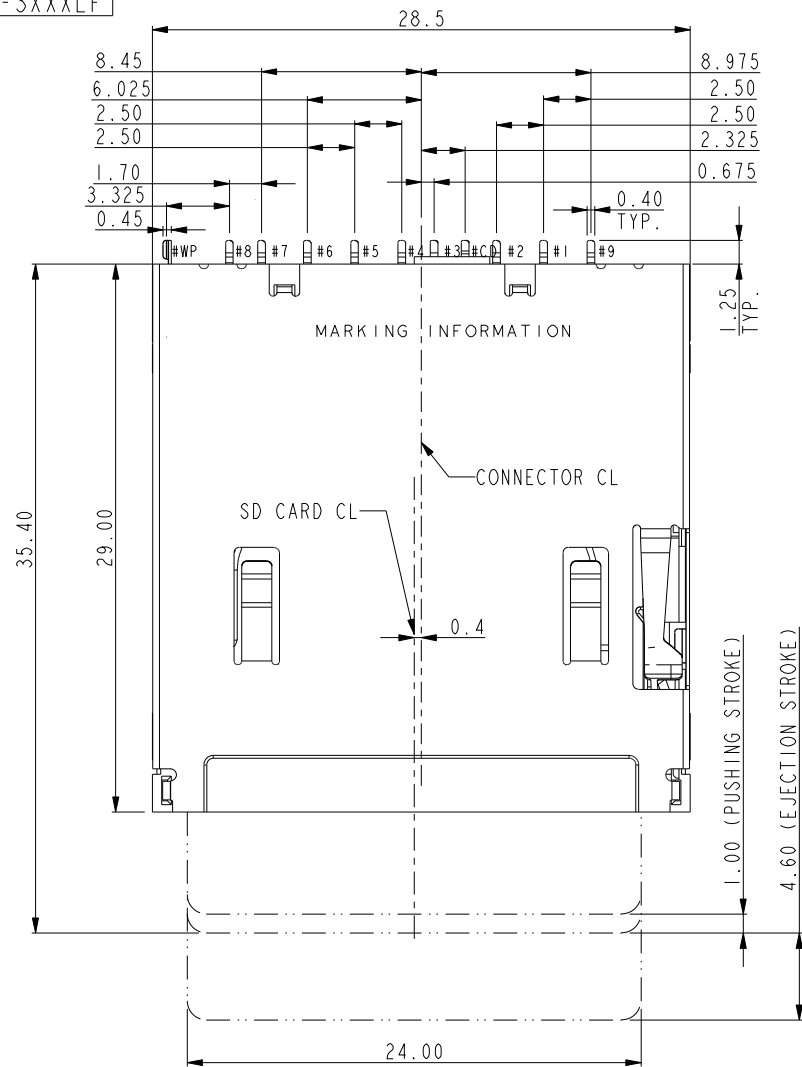

Copyright FCI.

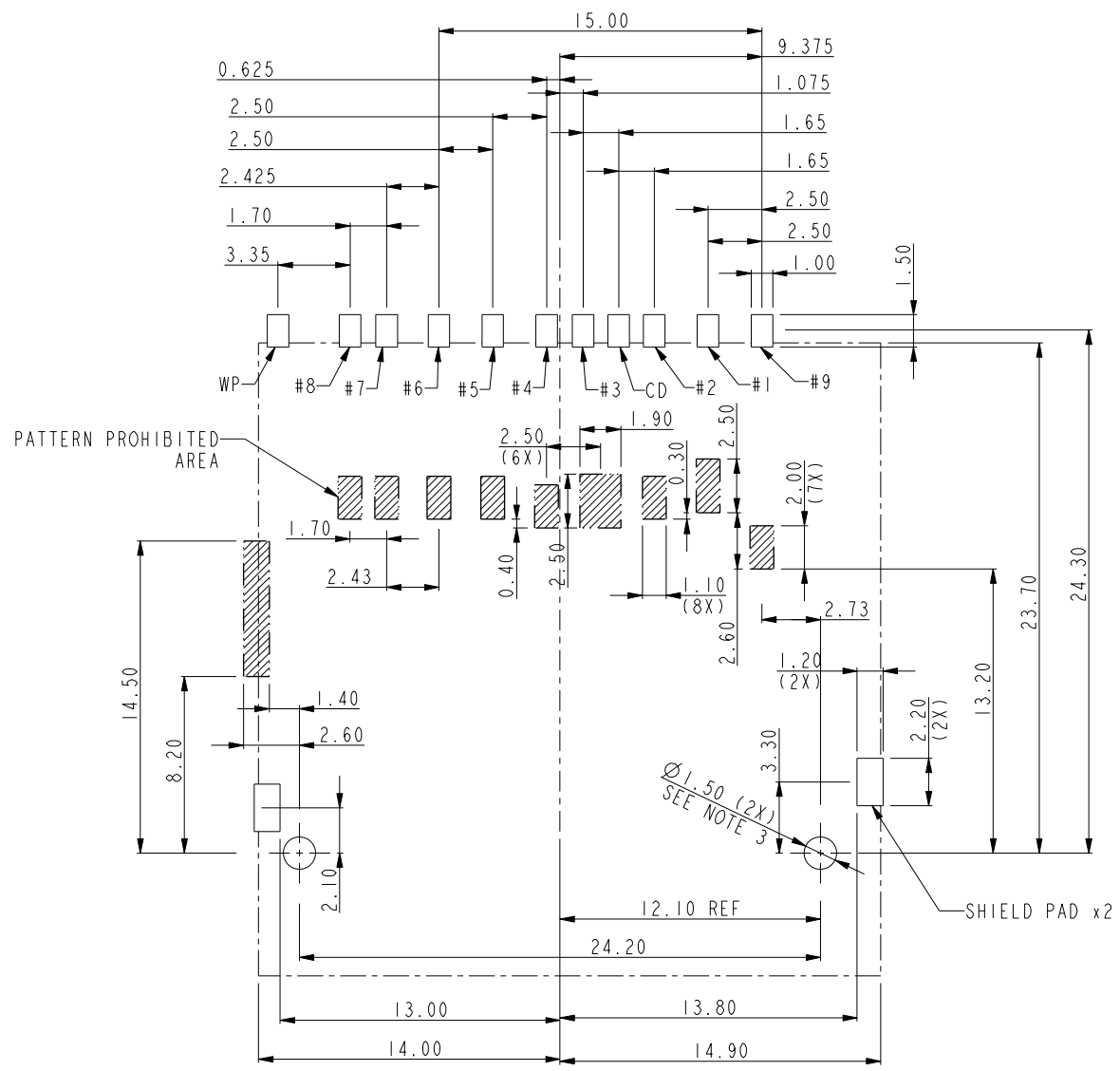

www.fciconnect.com			surface <input checked="" type="checkbox"/>	tolerance std ASME Y14.5	projection 	MM
			TOLERANCES UNLESS OTHERWISE SPECIFIED			
Dr	LEIF SHEN	05-18-06	ANGULAR	LINEAR	0.X	±0.30
Eng	LEIF SHEN	05-18-06			0.XX	±0.20
Chr	PAUL WANG	05-18-06	0°	±2°	0.XXX	±0.10
Appr	JOSEPH HSIA	05-18-06	Product family		SD	Spec ref
title			ASSEMBLY		dwg no	10067847-301
			SD CARD READER			Rev. A
catalog no			10067847		CUSTOMER	sheet 2 of 3

REV F - 2006-04-17

CIRCUIT :

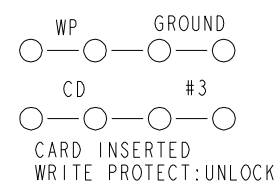
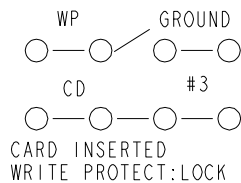
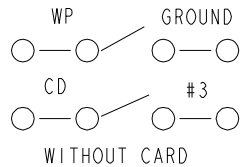

NOTES:

- 1. MATERIAL
HOUSING : HIGH TEMPERATURE THERMOPLASTIC RESIN.
CONTACT : COPPER ALLOY
SHIELD : STAINLESS.
- 2 PLATING:
CONTACT : 50u" NICKEL UNDERPLATED ALL OVER.
100u" MATTE TIN ON SOLDER TAIL AREA.
GOLD PLATED ON CONTACT AREA (SEE CONTACT PLATING IN NOTE 3).
- 3. PART NUMBER DESCRIPTION:
10067847-3 X X X X

- LF: LEAD FREE
- R : TAPE & REEL
- CONTACT PLATING :
1: 50u" Au OVER Ni
0: WITH PLASTIC PEG
I: WITHOUT PLASTIC PEG

4 MARKING INFORMATION

- PXXXXXXXXXX
- V2: UD321 OR PD910 LUBRICANT
- V3: UD321 OR PD910 LUBRICANT WITH ENGINEERING CHANGE BASED ON PCN09116.
- PRODUCTION LINE CODE
- DATE CODE THROUGH 01 TO 31
- WEEK NUMBER 01 THROUGH 53
- YEAR CODE:
MOST RIGHT OF DIGIT OF PRODUCTION.
(e.g. 2008=8)
- MANUFACTURE SITE; 2 FOR DONGGUAN
SOURCE; P FOR CHINA

PIN ASSIGNMENT

NO.	DESCRIPTION
#1	CD/DAT3
#2	CMD
#3	VSS
#4	VDD
#5	CLK
#6	VSS
#7	DAT0
#8	DAT1
#9	DAT2
#CD	CARD DETECTION
#WP	WRITE PROTECT
#GND	GROUND



Copyright FCI.

www.fciconnect.com			surface <input checked="" type="checkbox"/>	tolerance std ASME Y14.5	projection 	MM 			
			TOLERANCES UNLESS OTHERWISE SPECIFIED						
Dr	LEIF SHEN	05-18-06	ANGULAR	LINEAR	0.X	±0.30	size A4	Scale 1.000	
Eng	LEIF SHEN	05-18-06			0.XX	±0.20			
Chr	PAUL WANG	05-18-06			0°	±2°			0.XXX
Appr	JOSEPH HSIA	05-18-06	Product family		SD	Spec ref	RELEASED		
			title ASSEMBLY SD CARD READER			dwg no 10067847-301	Rev. A		
			catalog no 10067847			CUSTOMER	sheet 3 of 3		