

- Typical Applications**
- Broadband, Low Noise Gain Blocks
 - IF or RF Buffer Amplifiers
 - Driver Stage for Power Amplifiers
 - Final PA for Low Power Applications
 - Broadband Test Equipment

Product Description

The RF2336 is a general purpose, low-cost RF amplifier IC. The device is manufactured on an advanced Gallium Arsenide Heterojunction Bipolar Transistor (HBT) process, and has been designed for use as an easily-cascadable 50Ω gain block. Applications include IF and RF amplification in wireless voice and data communication products operating in frequency bands up to 3000MHz. The device is self-contained with 50Ω input and output impedances and requires only two external DC biasing elements to operate as specified. The RF2336 is available in a very small industry-standard SOT23-5 surface mount package, enabling compact designs which conserve board space.

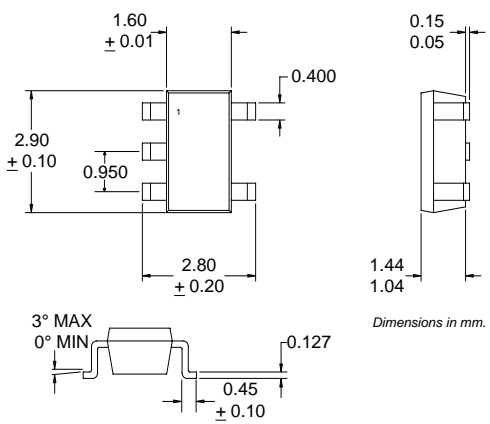

Optimum Technology Matching® Applied

- | | | |
|-------------------------------------|--|---------------------------------------|
| <input type="checkbox"/> Si BJT | <input checked="" type="checkbox"/> GaAs HBT | <input type="checkbox"/> GaAs MESFET |
| <input type="checkbox"/> Si Bi-CMOS | <input type="checkbox"/> SiGe HBT | <input type="checkbox"/> Si CMOS |
| <input type="checkbox"/> InGaP/HBT | <input type="checkbox"/> GaN HEMT | <input type="checkbox"/> SiGe Bi-CMOS |

Package Style: SOT23-5

- Features**
- DC to 6000MHz Operation
 - Internally matched Input and Output
 - 19dB Small Signal Gain at 1GHz
 - 3.8dB Noise Figure
 - 10mW Linear Output Power
 - Single Positive Power Supply

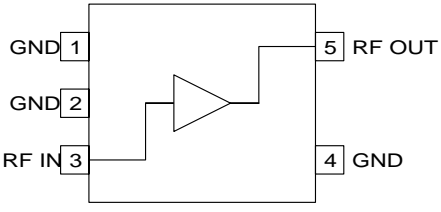

Functional Block Diagram

Ordering Information

RF2336	General Purpose Amplifier
RF2336 PCBA	Fully Assembled Evaluation Board

RF Micro Devices, Inc.
7628 Thorndike Road
Greensboro, NC 27409, USA

Tel (336) 664 1233
Fax (336) 664 0454
<http://www.rfmd.com>

RF2336

Absolute Maximum Ratings

Parameter	Rating	Unit
Input RF Power	+15	dBm
Operating Ambient Temperature	-40 to +85	°C
Storage Temperature	-60 to +150	°C



Caution! ESD sensitive device.

RF Micro Devices believes the furnished information is correct and accurate at the time of this printing. However, RF Micro Devices reserves the right to make changes to its products without notice. RF Micro Devices does not assume responsibility for the use of the described product(s).

Parameter	Specification			Unit	Condition
	Min.	Typ.	Max.		
Overall					T=25°C, I _{CC} =35mA
Frequency Range		DC to 6000		MHz	
Gain		22		dB	Freq=100MHz
		19.5		dB	Freq=1000MHz
		16.5		dB	Freq=2000MHz
		14.0		dB	Freq=3000MHz
Noise Figure		3.8		dB	Freq=2000MHz
Input VSWR		2.3:1			In a 50Ω system, DC to 3000MHz
Output VSWR		2.4:1			In a 50Ω system, DC to 3000MHz
Output IP ₃		+22.5		dBm	Freq=2000MHz±50kHz, P _{TONE} =-18dBm
Output P _{1dB}		+11.5		dBm	Freq=2000MHz
Reverse Isolation		20.7		dB	Freq=2000MHz
Thermal					I _{CC} =35mA, P _{DISS} =115mW (See Note.)
Theta _{JC}		322		°C/W	
Maximum Measured Junction Temperature		122		°C	T _{AMB} =+85°C, V _{PIN} =3.29V
Mean Time Between Failures		5000		years	See Note.
Power Supply					With 22Ω bias resistor
Device Operating Voltage		3.5		V	At pin 5 with I _{CC} =35mA
Supply Voltage		4.3		V	At evaluation board connector, I _{CC} =35mA
Operating Current		35	48	mA	See note.

Note: Because of process variations from part to part, the current resulting from a fixed bias voltage will vary. As a result, caution should be used in designing fixed voltage bias circuits to ensure the worst case bias current does not exceed 48mA over all intended operating conditions.

Pin	Function	Description	Interface Schematic
1	GND	Ground connection. For best performance, keep traces physically short and connect immediately to ground plane.	
2	GND	Same as pin 1.	
3	RF IN	RF input pin. This pin is NOT internally DC-blocked. A DC-blocking capacitor, suitable for the frequency of operation, should be used in most applications. DC coupling of the input is not allowed, because this will override the internal feedback loop and cause temperature instability.	
4	GND	Same as pin 1.	
5	RF OUT	RF output and bias pin. Biasing is accomplished with an external series resistor and choke inductor to V_{CC} . The resistor is selected to set the DC current into this pin to a desired level. The resistor value is determined by the following equation: $R = \frac{(V_{SUPPLY} - V_{DEVICE})}{I_{CC}}$ Care should also be taken in the resistor selection to ensure that the current into the part never exceeds 48mA over the planned operating temperature. This means that a resistor between the supply and this pin is always required, even if a supply near 3.5V is available, to provide DC feedback to prevent thermal runaway. Because DC is present on this pin, a DC blocking capacitor, suitable for the frequency of operation, should be used in most applications. The supply side of the bias network should also be well bypassed.	

Evaluation Board Schematic

(Download [Bill of Materials](http://www.rfmd.com) from www.rfmd.com.)

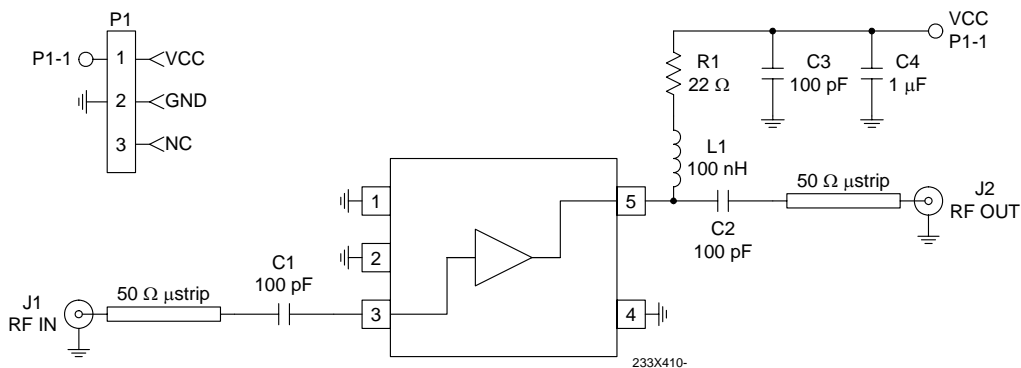

RF2336

Evaluation Board Layout Board Size 1.0" x 1.0"

Board Thickness 0.020", Board Material R0-4003 Rogers

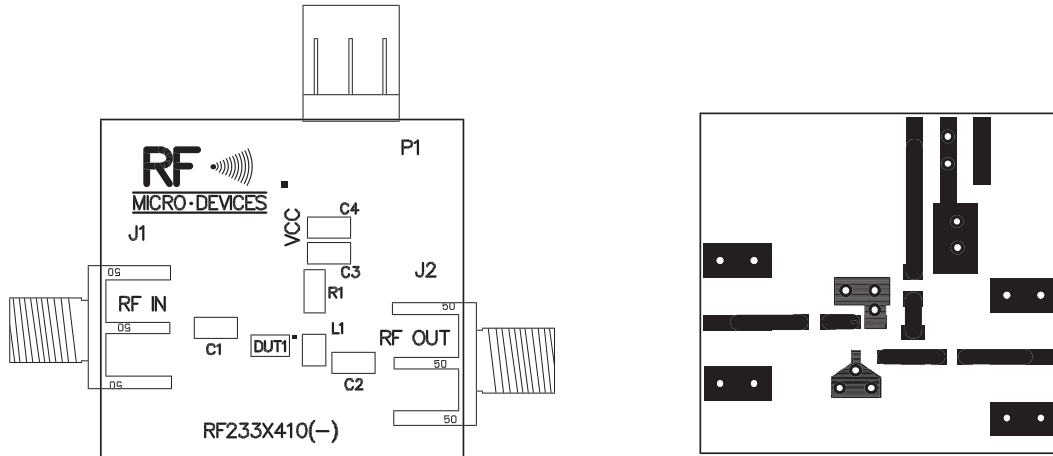

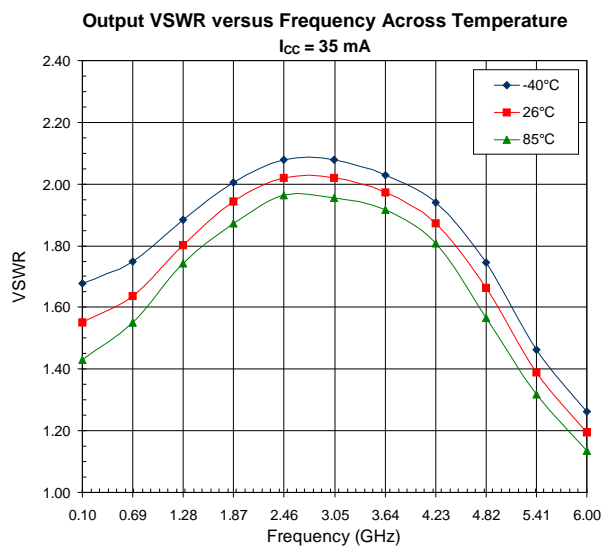
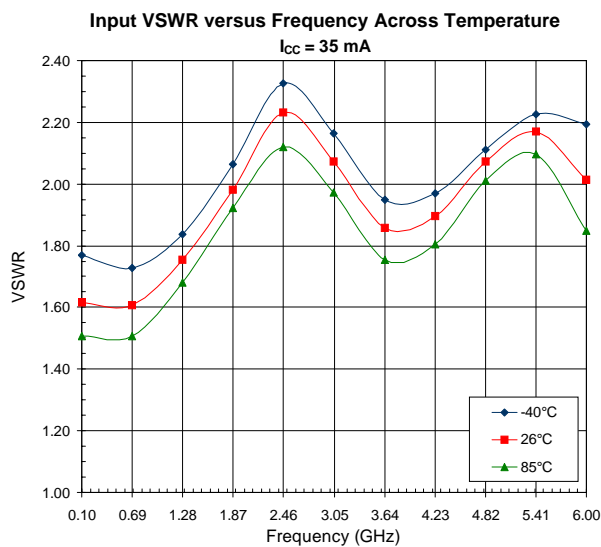
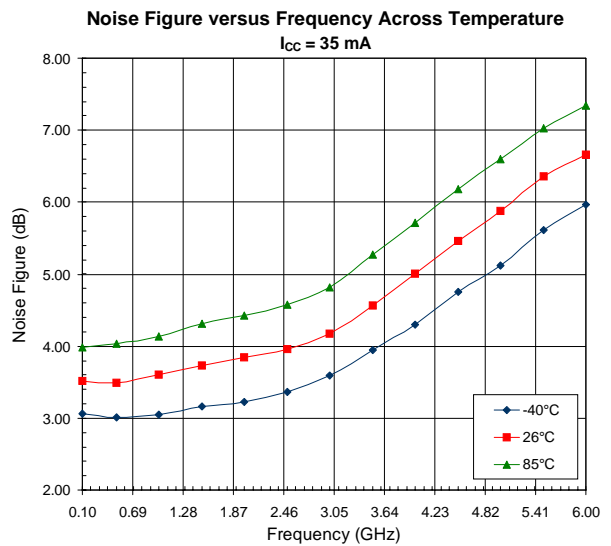
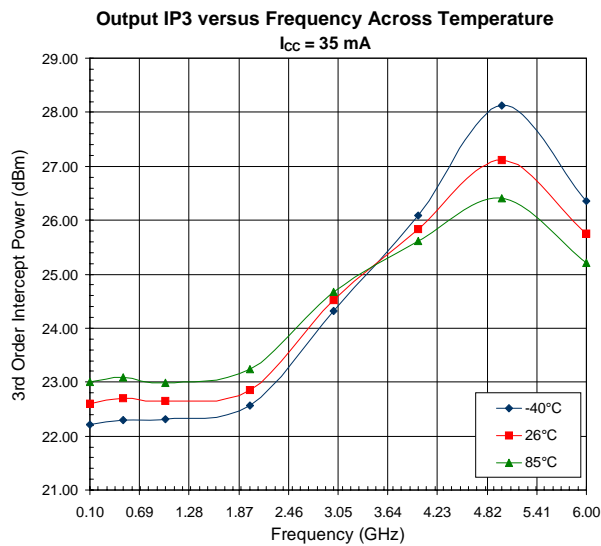
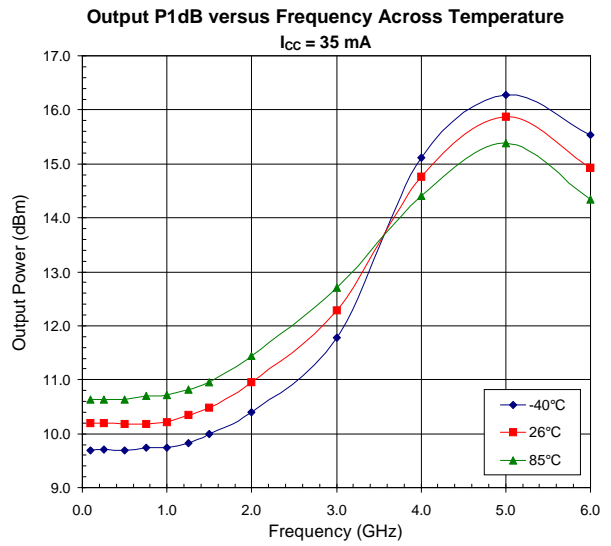
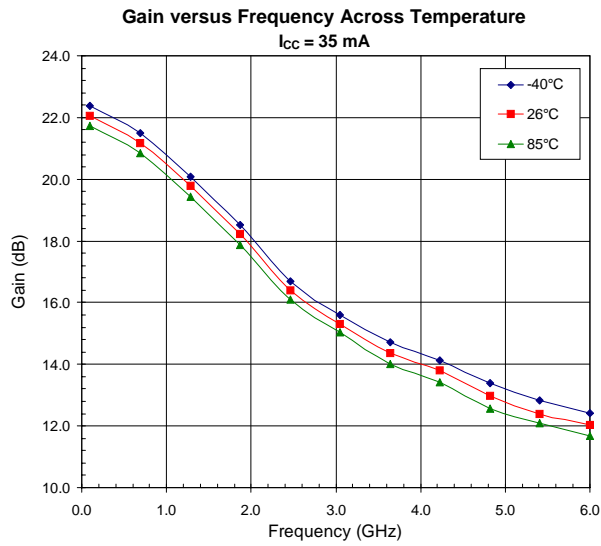

RF2336

Reverse Isolation versus Frequency Across Temperature, $I_{CC} = 35 \text{ mA}$

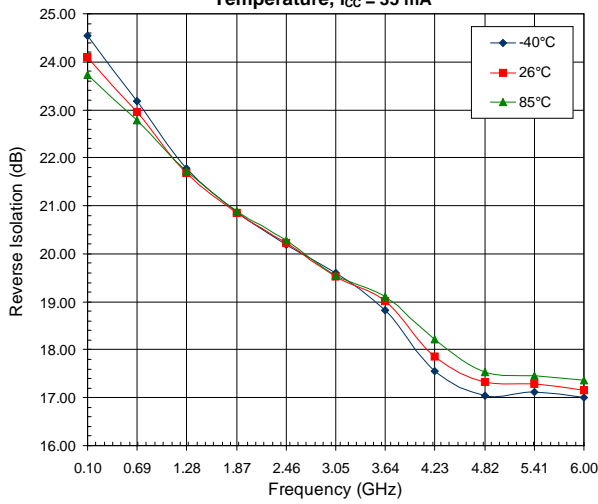

Current versus Voltage (At Evaluation Board Connector, $R_{BIAS} = 22\Omega$)

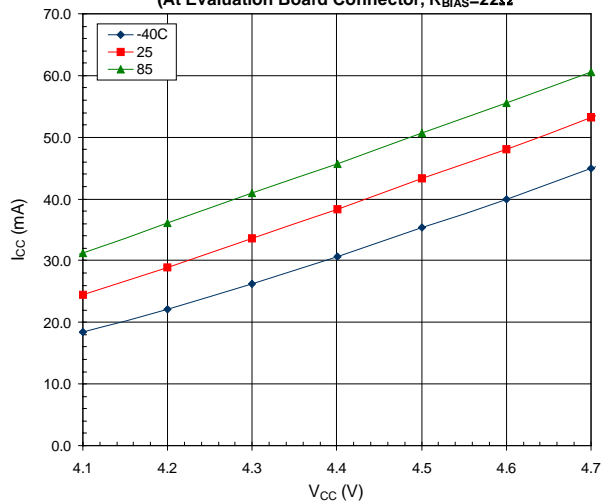

Current versus Voltage (At pin 5 of the RF2336)

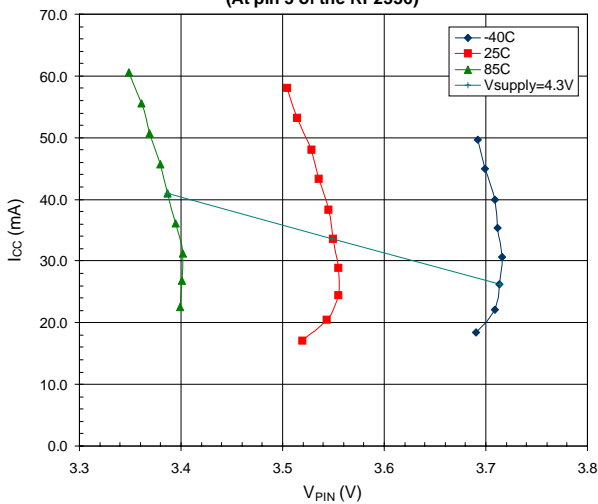

Power Dissipated versus Voltage at Pin 5 ($T_{AMBIENT} = +85^\circ\text{C}$)

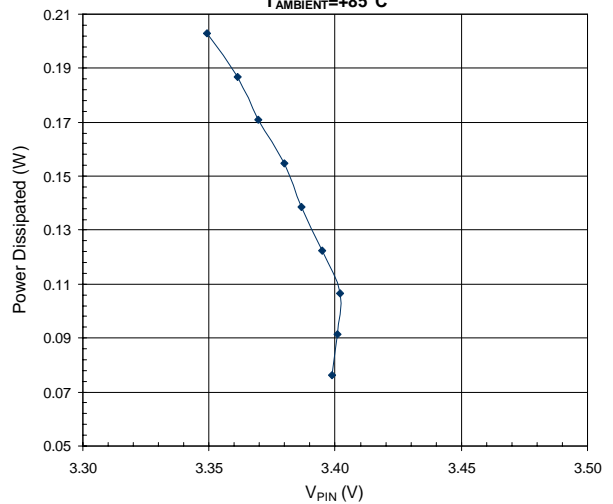

Junction Temperature versus Power Dissipated ($T_{AMBIENT} = 85^\circ\text{C}$)

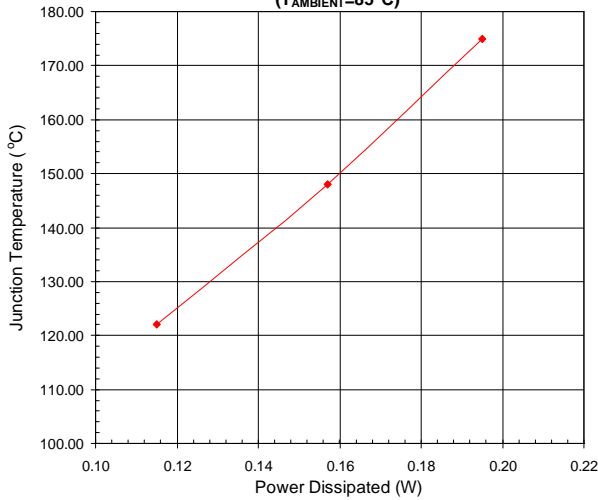

MTTF versus Junction Temperature (60% Confidence Interval)

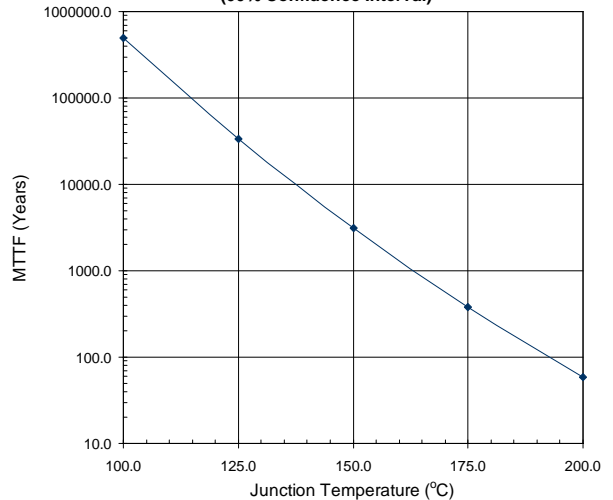

De-Embedded S11, $V_{CC} = 3.63V$, $I_{CC} = 35mA$, $T = 25^{\circ}C$

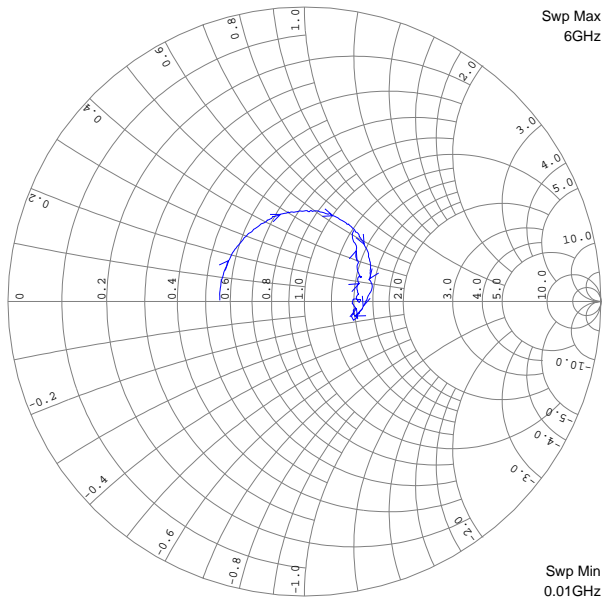

De-Embedded S22, $V_{CC} = 3.63V$, $I_{CC} = 35mA$, $T = 25^{\circ}C$

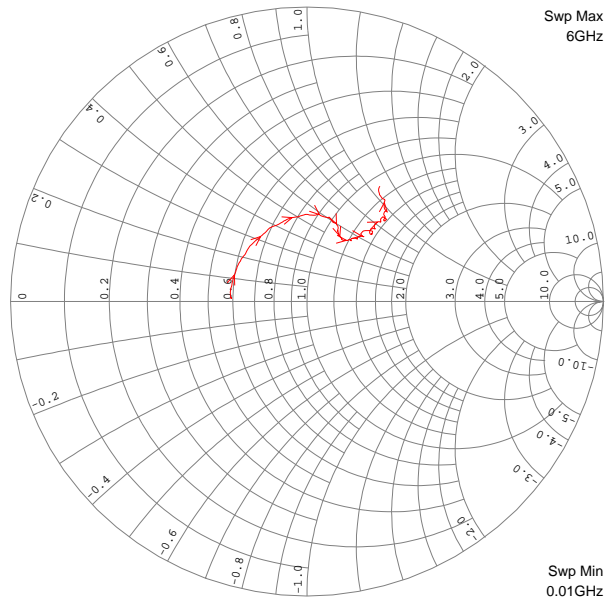

RF2336