

THIS DOCUMENT IS THE PROPERTY OF
KEYSTONE ELECTRONICS CORP. AND
SHALL NOT BE REPRODUCED, DISTRIBUTED
OR USED AS A BASIS FOR MANUFACTURE
WITHOUT PRIOR WRITTEN PERMISSION
FROM KEYSTONE ELECTRONICS CORP.

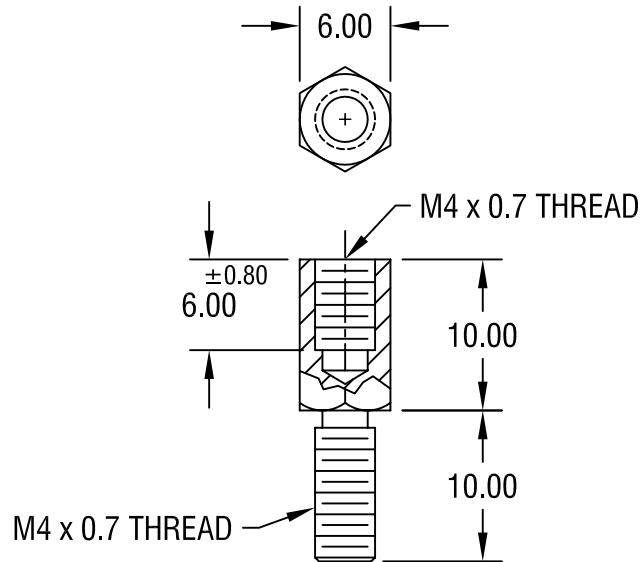

NOTE:

1. ALL DIMENSIONS ARE IN MILLIMETERS

KEYSTONE ELECTRONICS CORP.			
ASTORIA, N.Y. 11105-2017			
PART NAME		6.0mm M/F HEX STANDOFF	
MATERIAL		BRASS	
FINISH		DRN BY	DATE
NICKEL PLATE		BOONE	5.8.06
		APP'D	SCALE
		LN	2X
TOLERANCES	INCH	[MM]	CODE
DECIMAL	±	[± 0.15]	C/M
ANGULAR	± 1°		
UNLESS OTHERWISE SPECIFIED			DWG NO.
			24325

DATE	DESCRIPTION	REV.