

PRODUCT DATASHEET

Strada series

last update 19/10/2015

Product number	C11415_STRADA-T-DN		
Family	Strada	FWHM	Asymmetric degrees
Type	Lens	Efficiency	92 %
LED	XP-E	cd/lm	-
Color	Clear	Gerber File	Available
Diameter	19.8 x 15.5 mm		
Height	8.75 mm		
Style	Rectang		
Optic Material	PMMA		
Holder Material	-		
Fastening	["screw", "glue", "pin"]		
Status	Production ready		
Product number	CA11416_STRADA-T-DN		
Family	Strada	FWHM	Asymmetric degrees
Type	Assembly	Efficiency	92 %
LED	XP-E	cd/lm	-
Color	Clear	Gerber File	Available
Diameter	19.8 x 15.5 mm		
Height	8.75 mm		
Style	Rectang		
Optic Material	PMMA		
Holder Material	-		
Fastening	["tape", "pin", "screw"]		
Status	Production ready		
Product number	C11425_STRADA-T-DW		
Family	Strada	FWHM	Asymmetric degrees
Type	Lens	Efficiency	93 %
LED	XP-E	cd/lm	-
Color	Clear	Gerber File	Available
Diameter	19.6 x 15.5 mm		
Height	10.7 mm		
Style	Rectang		
Optic Material	PMMA		
Holder Material	-		
Fastening	["pin", "tape"]		
Status	Production ready		
Product number	CA11426_STRADA-T-DW		
Family	Strada	FWHM	Asymmetric degrees
Type	Assembly	Efficiency	92 %
LED	XP-E	cd/lm	-
Color	Clear	Gerber File	Available
Diameter	19.6 x 15.5 mm		
Height	10.7 mm		
Style	Rectang		
Optic Material	PMMA		
Holder Material	-		
Fastening	["pin", "tape", "screw"]		
Status	Production ready		

PRODUCT DATASHEET

Strada series

last update 19/10/2015

Product number 2F11896_STRADA-T-DN-EP

Family	Strada	FWHM	Asymmetric degrees
Type	Lens	Efficiency	92 %
LED	XP-E	cd/lm	-
Color	Clear	Gerber File	Available
Diameter	19.8 x 15.5 mm	No position element, Customer needs own fixture for assembling	
Height	8.75 mm		
Style	Rectang		
Optic Material	PMMA		
Holder Material	-		
Fastening	["glue", "screw"]		
Status	Production ready		

Product number 2F11898_STRADA-T-DW-EP

Family	Strada	FWHM	Asymmetric degrees
Type	Lens	Efficiency	92 %
LED	XP-E	cd/lm	-
Color	Clear	Gerber File	Available
Diameter	19.6 x 15.5 mm	No position element, Customer needs own fixture for assembling	
Height	10.7 mm		
Style	Rectang		
Optic Material	PMMA		
Holder Material	-		
Fastening	["glue", "screw"]		
Status	Production ready		

Product number 2FA11992_STRADA-T-DN-EP

Family	Strada	FWHM	Asymmetric degrees
Type	Assembly	Efficiency	92 %
LED	XP-E	cd/lm	-
Color	Clear	Gerber File	Available
Diameter	19.8 x 15.5 mm	No position element, Customer needs own fixture for assembling	
Height	8.75 mm		
Style	Rectang		
Optic Material	PMMA		
Holder Material	-		
Fastening	["tape", "screw"]		
Status	Production ready		

Product number 2FA11993_STRADA-T-DW-EP

Family	Strada	FWHM	Asymmetric degrees
Type	Assembly	Efficiency	92 %
LED	XP-E	cd/lm	-
Color	Clear	Gerber File	Available
Diameter	19.6 x 15.5 mm	No position element, Customer needs own fixture for assembling	
Height	10.7 mm		
Style	Rectang		
Optic Material	PMMA		
Holder Material	-		
Fastening	["tape", "screw"]		
Status	Production ready		

PRODUCT DATASHEET

Strada series

last update 19/10/2015

Product number C12049_STRADA-FT

Family Strada
Type Lens
LED XP-E
Color Clear
Diameter 15.4 x 19.6 mm
Height 8.2 mm
Style Rectang
Optic Material PMMA
Holder Material -
Fastening ["screw", "glue", "pin"]
Status Production ready

FWHM Asymmetric degrees
Efficiency 92 %
cd/lm -
Gerber File Available

http://www.ledil.fi/Strada-F_Fully_Asymmetrical_Forward_Throw_Lens_Family

Product number CA12050_STRADA-FT

Family Strada
Type Assembly
LED XP-E
Color Clear
Diameter 15.4 x 19.6 mm
Height 8.35 mm
Style Rectang
Optic Material PMMA
Holder Material -
Fastening ["tape", "pin", "screw"]
Status Production ready

FWHM Asymmetric degrees
Efficiency 92 %
cd/lm -
Gerber File Available

http://www.ledil.fi/Strada-F_Fully_Asymmetrical_Forward_Throw_Lens_Family

Product number C12086_STRADA-FW

Family Strada
Type Lens
LED XP-E
Color Clear
Diameter 15.4 x 19.6 mm
Height 10.66 mm
Style Rectang
Optic Material PMMA
Holder Material -
Fastening ["pin", "screw", "glue"]
Status Production ready

FWHM Asymmetric degrees
Efficiency 92 %
cd/lm -
Gerber File Available

http://www.ledil.fi/Strada-F_Fully_Asymmetrical_Forward_Throw_Lens_Family

Product number CA12087_STRADA-FW

Family Strada
Type Assembly
LED XP-E
Color Clear
Diameter 15.4 x 19.6 mm
Height 10.8 mm
Style Rectang
Optic Material PMMA
Holder Material -
Fastening ["tape", "pin", "screw"]
Status Production ready

FWHM Asymmetric degrees
Efficiency 92 %
cd/lm -
Gerber File Available

http://www.ledil.fi/Strada-F_Fully_Asymmetrical_Forward_Throw_Lens_Family

PRODUCT DATASHEET

Strada series

last update 19/10/2015

Product number	C10818_STRADA-A		
Family	Strada	FWHM	68+136 degrees
Type	Lens	Efficiency	93 %
LED	XP-E	cd/lm	1.100
Color	Clear	Gerber File	Available
Diameter	19.6 +15.4 mm		
Height	10.5 mm		
Style	Rectang		
Optic Material	PMMA		
Holder Material	-		
Fastening	["glue", "screw"]		
Status	Production ready		
Product number	CA10823_STRADA-A		
Family	Strada	FWHM	68+136 degrees
Type	Assembly	Efficiency	93 %
LED	XP-E	cd/lm	1.100
Color	Clear	Gerber File	Available
Diameter	19.6 +15.4 mm		
Height	10.65 mm		
Style	Rectang		
Optic Material	PMMA		
Holder Material	-		
Fastening	["tape", "screw"]		
Status	Production ready		
Product number	C12219_STRADA-A2		
Family	Strada	FWHM	68+ 136 degrees
Type	Lens	Efficiency	92 %
LED	XP-E	cd/lm	1.100
Color	Clear	Gerber File	Available
Diameter	19.6 +15.4 mm		
Height	10.5 mm		
Style	Rectang		
Optic Material	PMMA		
Holder Material	-		
Fastening	["glue", "screw", "pin"]		
Status	Production ready		
Product number	CA12220_STRADA-A2		
Family	Strada	FWHM	68+136 degrees
Type	Assembly	Efficiency	92 %
LED	XP-E	cd/lm	1.100
Color	Clear	Gerber File	Available
Diameter	19.6 +15.4 mm		
Height	10.65 mm		
Style	Rectang		
Optic Material	PMMA		
Holder Material	-		
Fastening	["screw", "pin", "tape"]		
Status	Production ready		

PRODUCT DATASHEET

Strada series

last update 19/10/2015

Product number	C11255_STRADA-DW		
Family	Strada	FWHM	90+140 degrees
Type	Lens	Efficiency	92 %
LED	XP-E	cd/lm	1.030
Color	Clear	Gerber File	Available
Diameter	19.6 x 15.7 mm		
Height	9 mm		
Style	Rectang		
Optic Material	PMMA		
Holder Material	-		
Fastening	-		
Status	Production ready		

Product number	CA11256_STRADA-DW		
Family	Strada	FWHM	90+140 degrees
Type	Assembly	Efficiency	92 %
LED	XP-E	cd/lm	1.030
Color	Clear	Gerber File	Available
Diameter	19.6 x 15.7 mm		
Height	9 mm		
Style	Rectang		
Optic Material	PMMA		
Holder Material	-		
Fastening	["screw", "pin", "tape"]		
Status	Production ready		

Product number	C10926_STRADA-B		
Family	Strada	FWHM	116+44 degrees
Type	Lens	Efficiency	93 %
LED	XP-E	cd/lm	0.560
Color	Clear	Gerber File	Available
Diameter	19.6 + 15.5 mm		
Height	5.2 mm		
Style	Rectang		
Optic Material	PMMA		
Holder Material	-		
Fastening	["glue", "screw"]		
Status	Production ready		

Product number	CA10927_STRADA-B		
Family	Strada	FWHM	116+44 degrees
Type	Assembly	Efficiency	93 %
LED	XP-E	cd/lm	0.560
Color	Clear	Gerber File	Available
Diameter	19.6 + 15.5 mm		
Height	5.2 mm		
Style	Rectang		
Optic Material	PMMA		
Holder Material	-		
Fastening	["tape", "screw"]		
Status	Production ready		

PRODUCT DATASHEET

Strada series

last update 19/10/2015

Product number CA11253_STRADA-C2

Family	Strada	FWHM	124 degrees
Type	Assembly	Efficiency	92 %
LED	XP-E	cd/lm	0.290
Color	Clear	Gerber File	Available
Diameter	19.6 x 15.6 mm		
Height	5.9 mm		
Style	Rectang		
Optic Material	PMMA		
Holder Material	-		
Fastening	["tape", "pin"]		
Status	Production ready		

Product number CA11248_STRADA-S

Family	Strada	FWHM	144+168 degrees
Type	Assembly	Efficiency	93 %
LED	XP-E	cd/lm	0.470
Color	Clear	Gerber File	Available
Diameter	19.6 x 15.5 mm		
Height	6.9 mm		Developed especially for side emitting applications
Style	Rectang		
Optic Material	PMMA		
Holder Material	-		
Fastening	["pin", "tape", "screw"]		
Status	Production ready		

Product number C11249_STRADA-S

Family	Strada	FWHM	144+168 degrees
Type	Lens	Efficiency	93 %
LED	XP-E	cd/lm	0.470
Color	Clear	Gerber File	Available
Diameter	19.6 x 15.5 mm		
Height	6.9 mm		Developed especially for side emitting applications
Style	Rectang		
Optic Material	PMMA		
Holder Material	-		
Fastening	["pin", "screw"]		
Status	Production ready		

NOTE: The typical divergence will be changed by different color, chip size and chip position tolerance. The typical total divergence is the full angle measured where the luminous intensity is half of the peak value.

PRODUCT DATASHEET

Strada series

last update 19/10/2015

GENERAL INFORMATION

- Product series especially designed & optimized for XP-E series of LEDs.
- Special care taken to make light distribution as uniform as possible.
- Lens material optical grade PMMA with high UV and temperature resistance. Allows use of high current and temperature conditions.

Please find more information about used material from below:

http://ledil.fi/sites/default/files/Documents/Technical/Material/PMMA%20N%20UL94_Yellow%20Card.pdf

<http://ledil.fi/sites/default/files/Documents/Technical/Material/PMMA%20N%20PLEXIGLAS-Datasheet.pdf>

D C B A

4

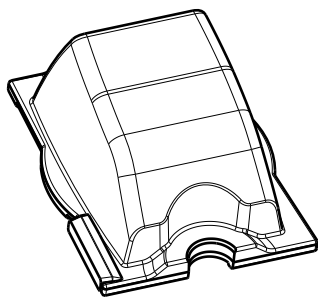

Isometric view

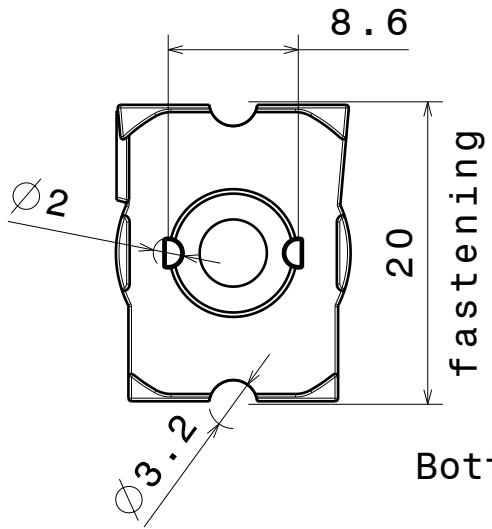

Bottom view

3

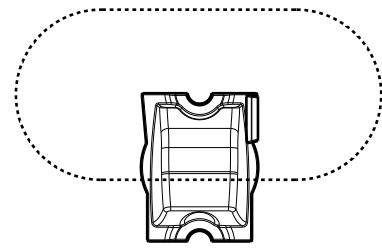

Beam direction

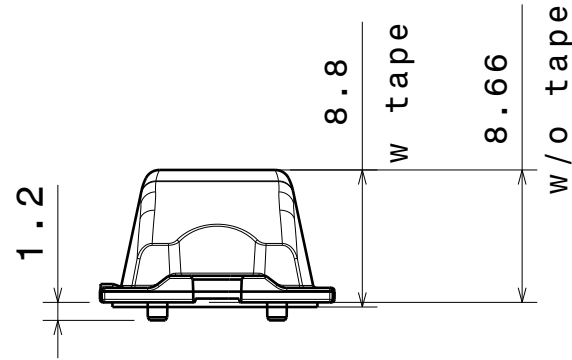

Front view

2

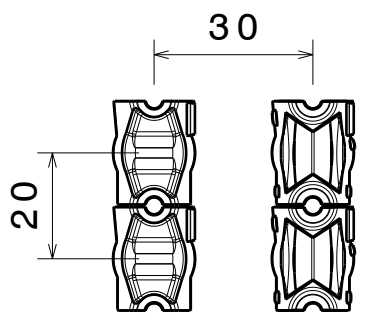

Strada lens arrangement recommendation

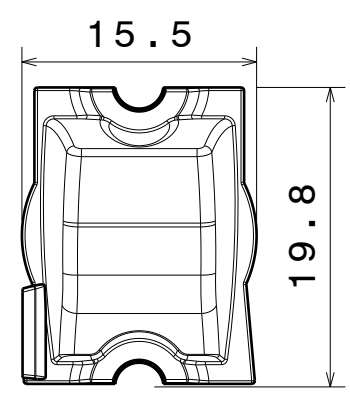

Top view

MATERIALS
 Lens: PMMA
 Tape(optional): PU Foam

Optical interface details are confidential and detail in this area may not reflect actual shape

1

1

This drawing is our property. It can't be reproduced or communicated without our written agreement.				Ledil Oy Salorankatu 10 FIN-24100 SALO Finland	
DRAWN BY ah		DATE 26.9.2012		Datasheet Strada-T-DN Lens	
CHECKED BY sn		DATE 26.9.2012			
DESIGNED BY hh		DATE 14.05.2010		SIZE A4	DRAWING NUMBER
		SCALE 2:1	WEIGHT (g)		REV 2
					SHEET 1/1

D A

Ledil Oy C11415_Strada-T-DN-XP C11415_Strada-T-DN-XP / LDC (Linear)

Luminaire: Ledil Oy C11415_Strada-T-DN-XP C11415_Strada-T-DN-XP
Lamps: 1 x Cree XP-E (White)

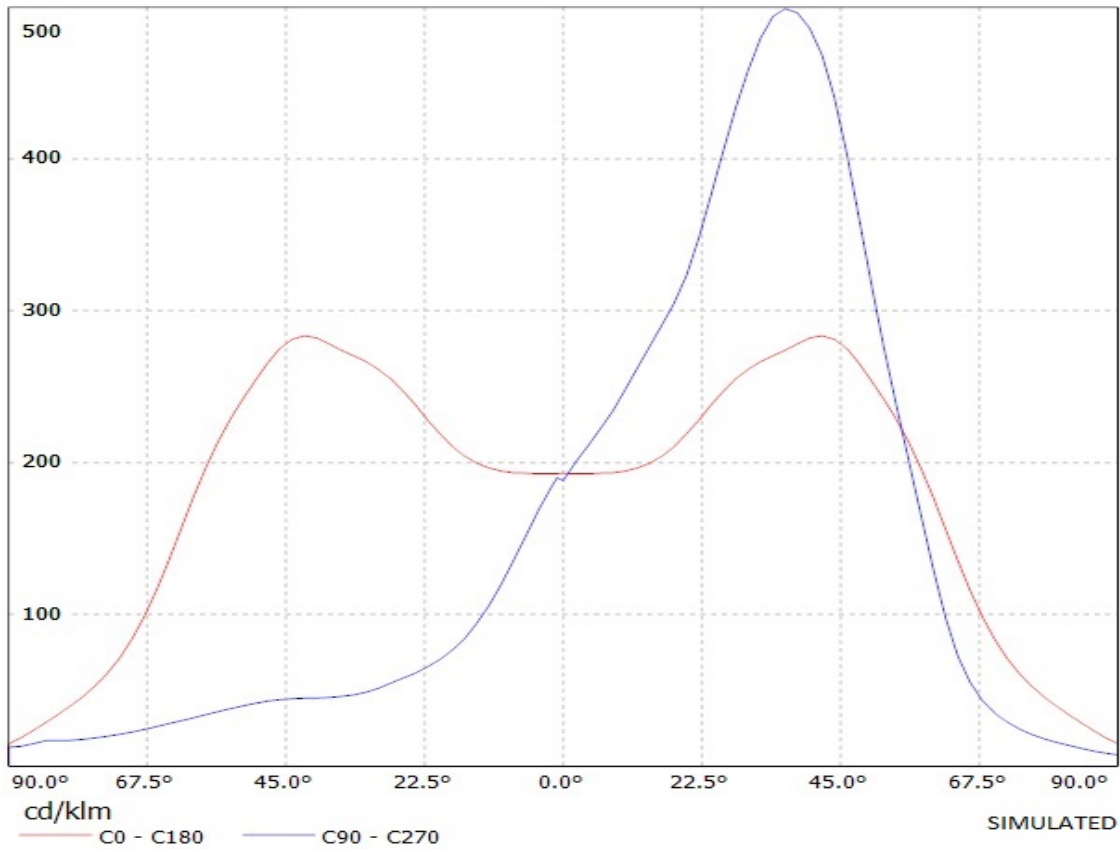

Ledil Oy C11415_Strada-T-DN-XP C11415_Strada-T-DN-XP / LDC (Linear)

Luminaire: Ledil Oy C11415_Strada-T-DN-XP C11415_Strada-T-DN-XP
Lamps: 1 x Cree XP-E (White)

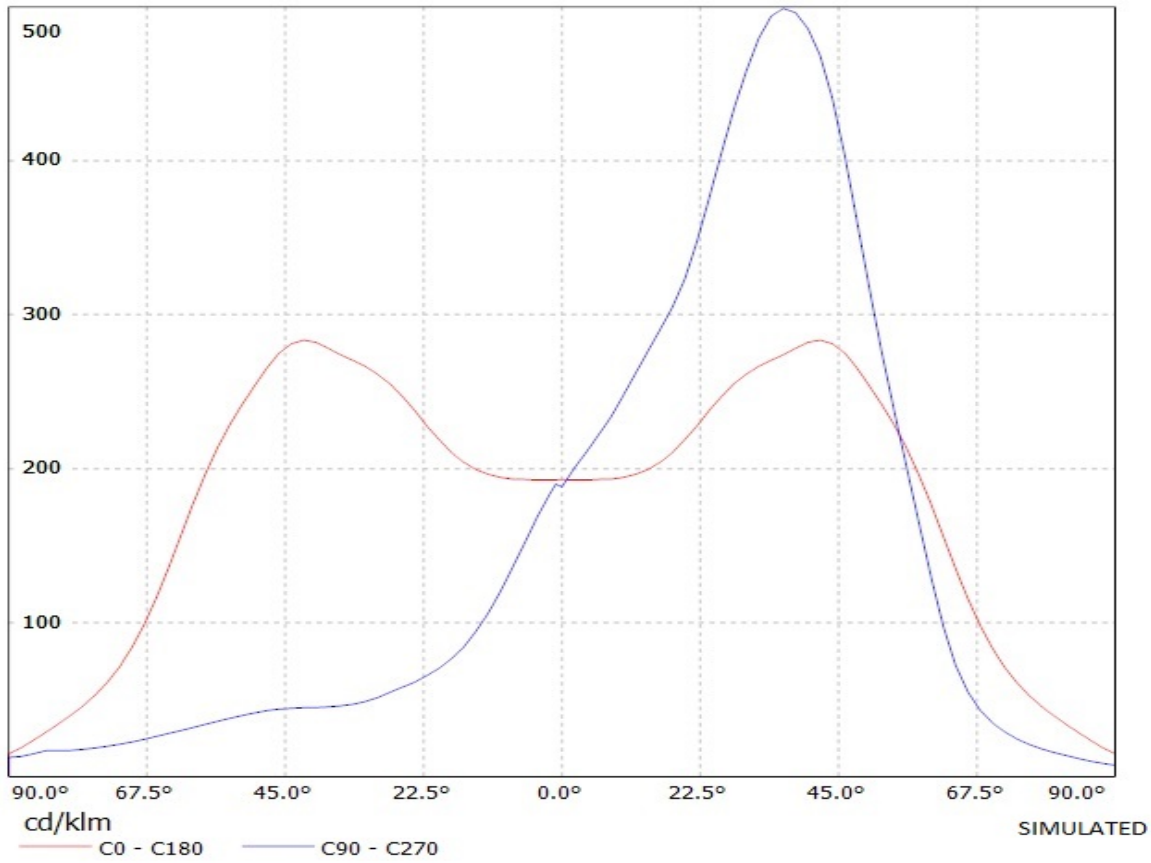

Ledil Oy C11425_Strada-T-DW-XP C11425_Strada-T-DW-XP / LDC (Linear)

Luminaire: Ledil Oy C11425_Strada-T-DW-XP C11425_Strada-T-DW-XP
Lamps: 1 x Cree XP-E (White)

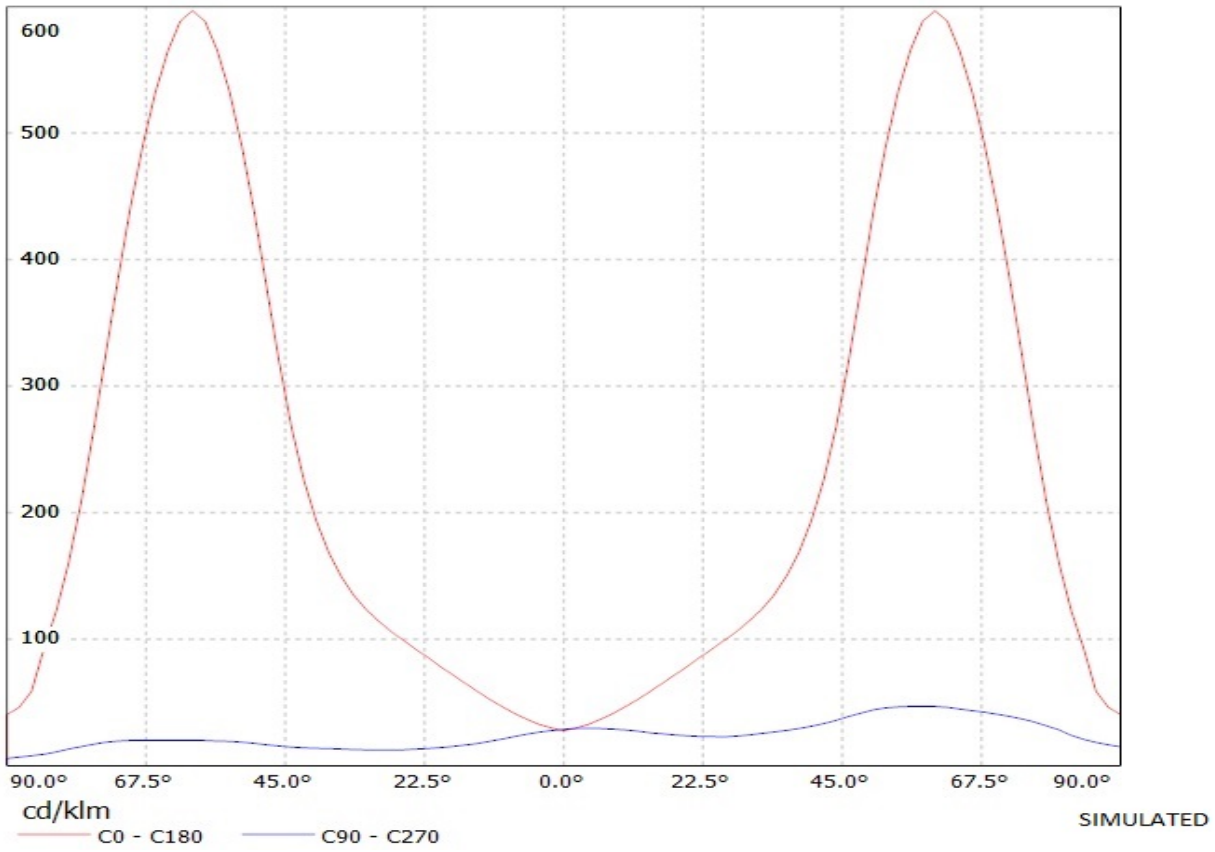

Ledil Oy C11425_Strada-T-DW-XP-G C11425_Strada-T-DW-XP-G / LDC (Linear)

Luminaire: Ledil Oy C11425_Strada-T-DW-XP-G C11425_Strada-T-DW-XP-G
Lamps: 1 x Cree Xp-G (White)

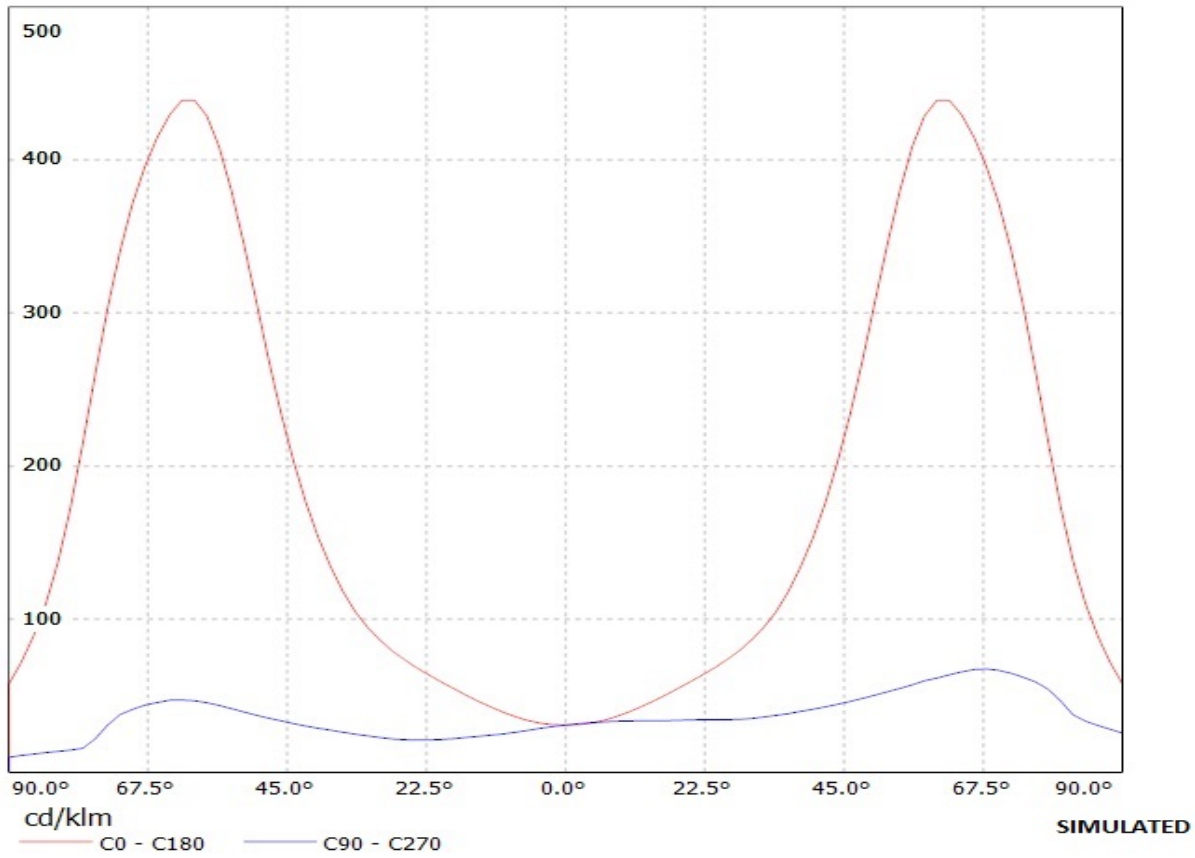

Ledil Oy C11415_Strada-T-DN-XP C11415_Strada-T-DN-XP / LDC (Linear)

Luminaire: Ledil Oy C11415_Strada-T-DN-XP C11415_Strada-T-DN-XP
Lamps: 1 x Cree XP-E (White)

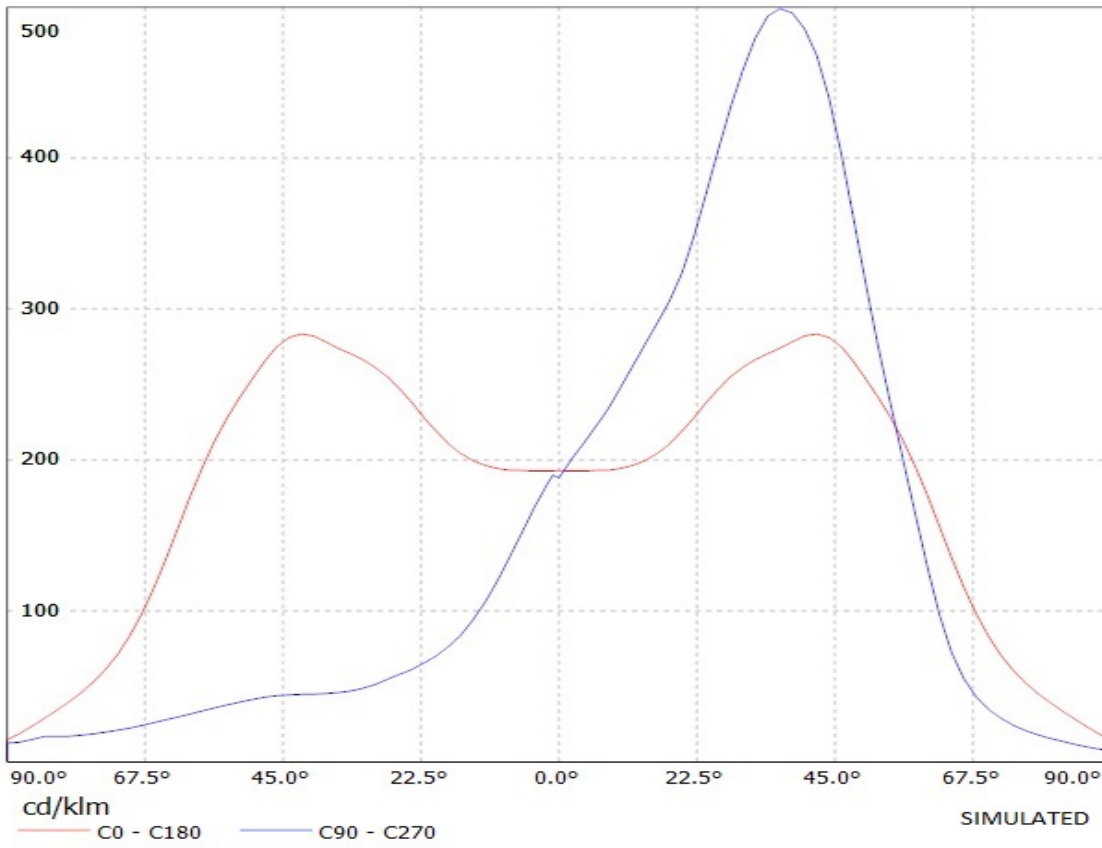

Ledil Oy C11425_Strada-T-DW-XP C11425_Strada-T-DW-XP / LDC (Linear)

Luminaire: Ledil Oy C11425_Strada-T-DW-XP C11425_Strada-T-DW-XP
Lamps: 1 x Cree XP-E (White)

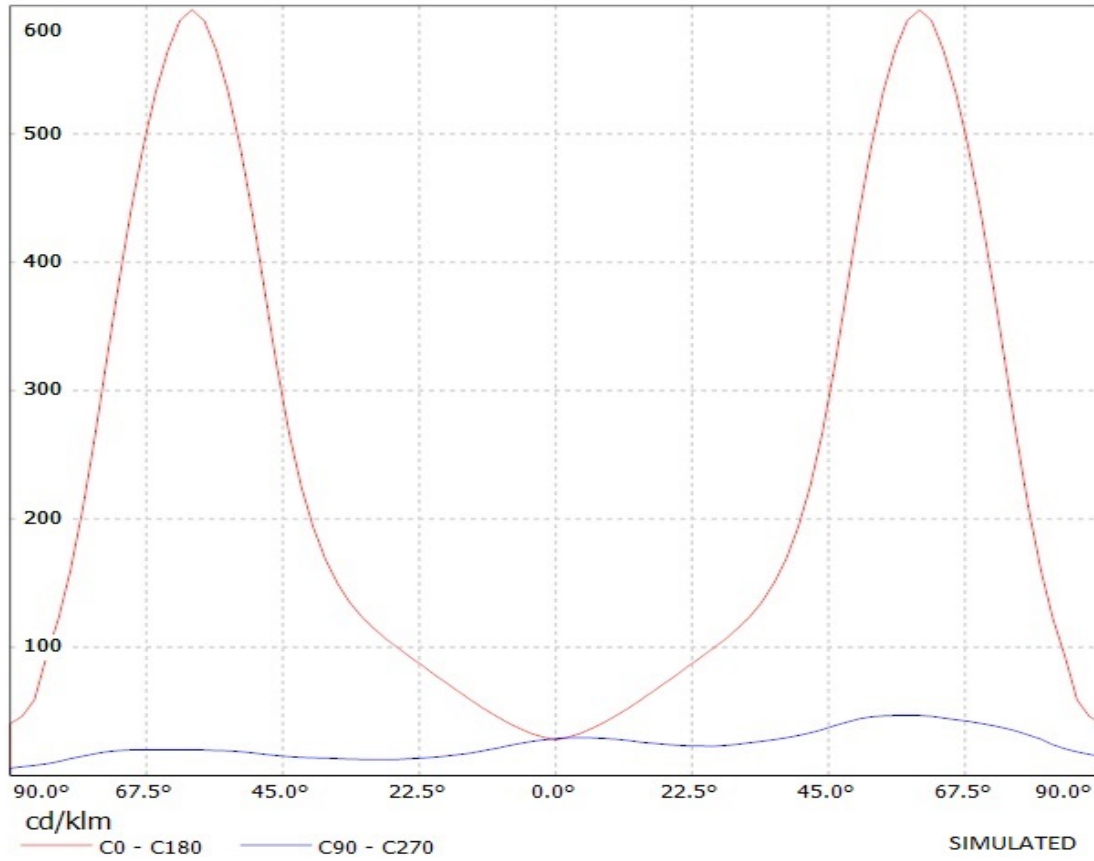

Ledil Oy C11415_Strada-T-DN-XP C11415_Strada-T-DN-XP / LDC (Linear)

Luminaire: Ledil Oy C11415_Strada-T-DN-XP C11415_Strada-T-DN-XP
Lamps: 1 x Cree XP-E (White)

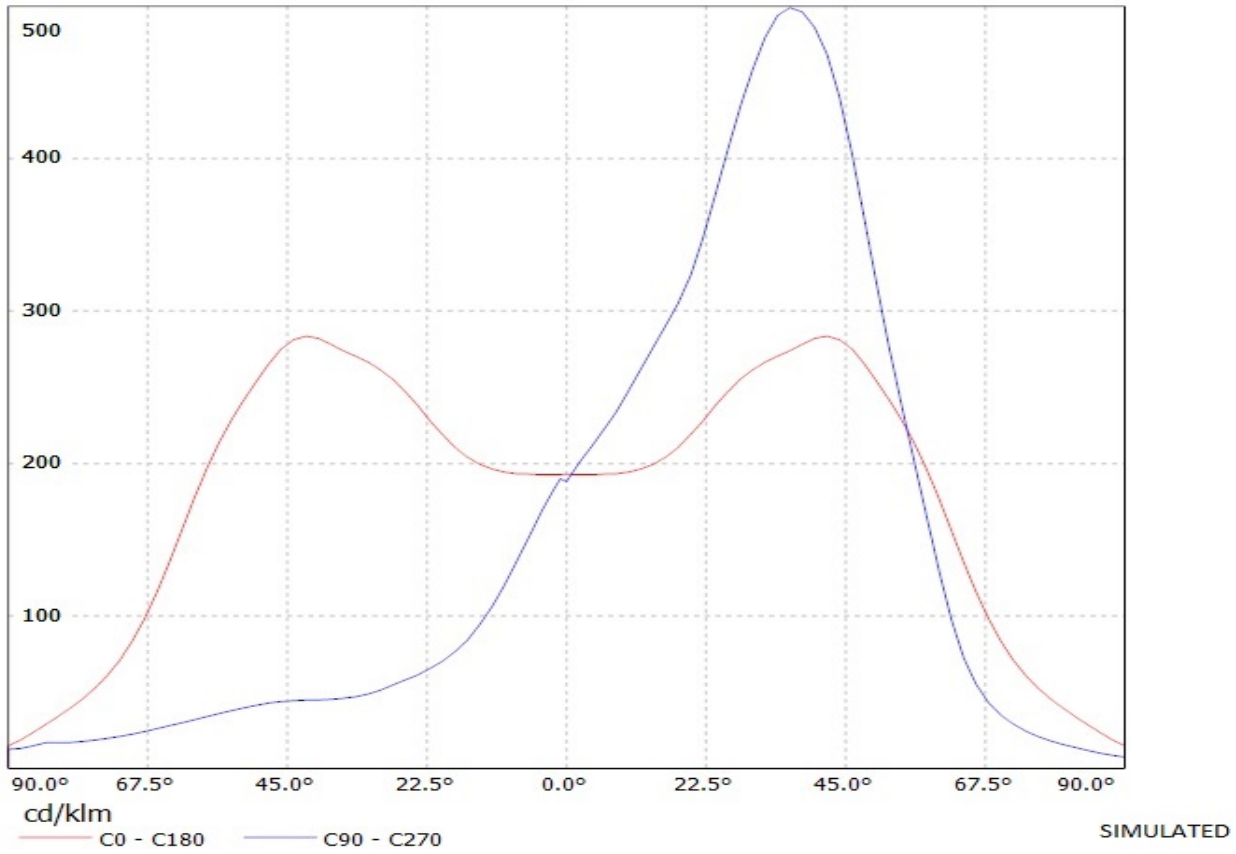

Ledil Oy C11425_Strada-T-DW-XP C11425_Strada-T-DW-XP / LDC (Linear)

Luminaire: Ledil Oy C11425_Strada-T-DW-XP C11425_Strada-T-DW-XP
Lamps: 1 x Cree XP-E (White)

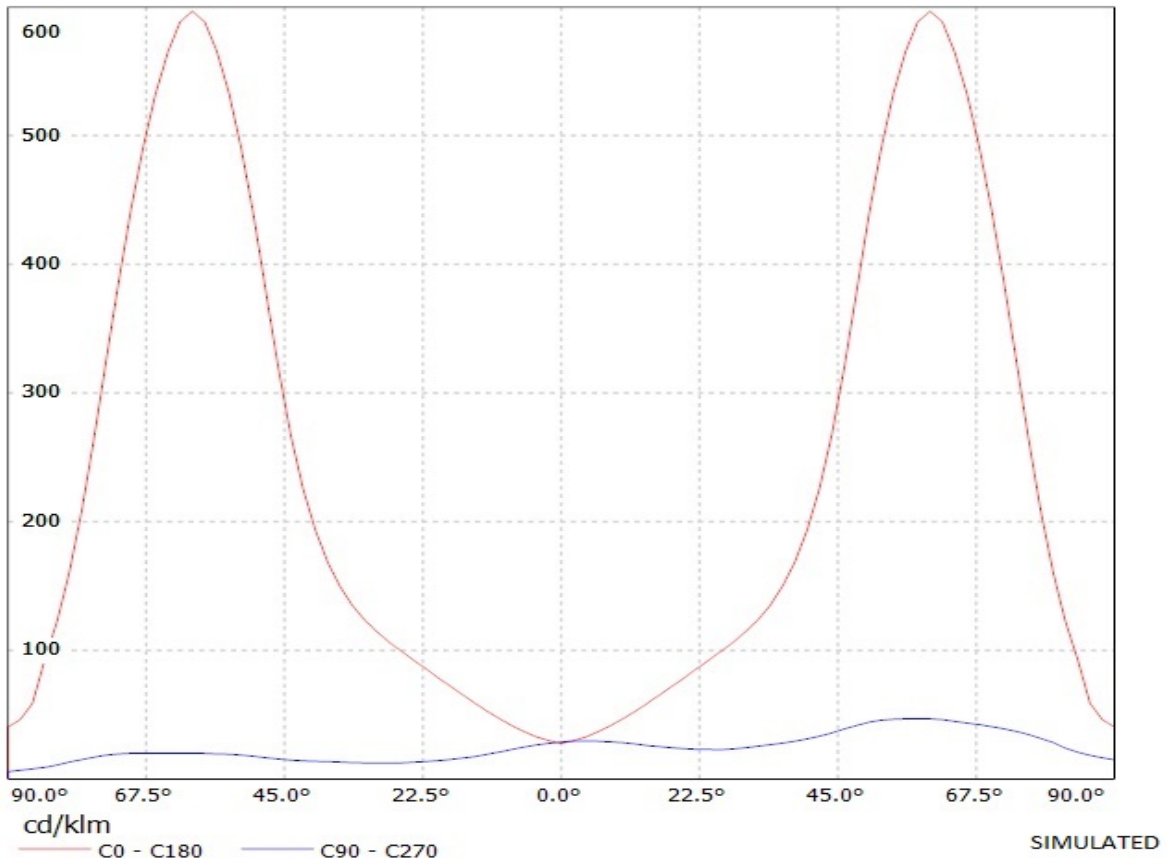

Luminaire: Ledil Oy C12049_Strada-FT-XP C12049_Strada-FT-XP
Lamps: 1 x Cree XP-E

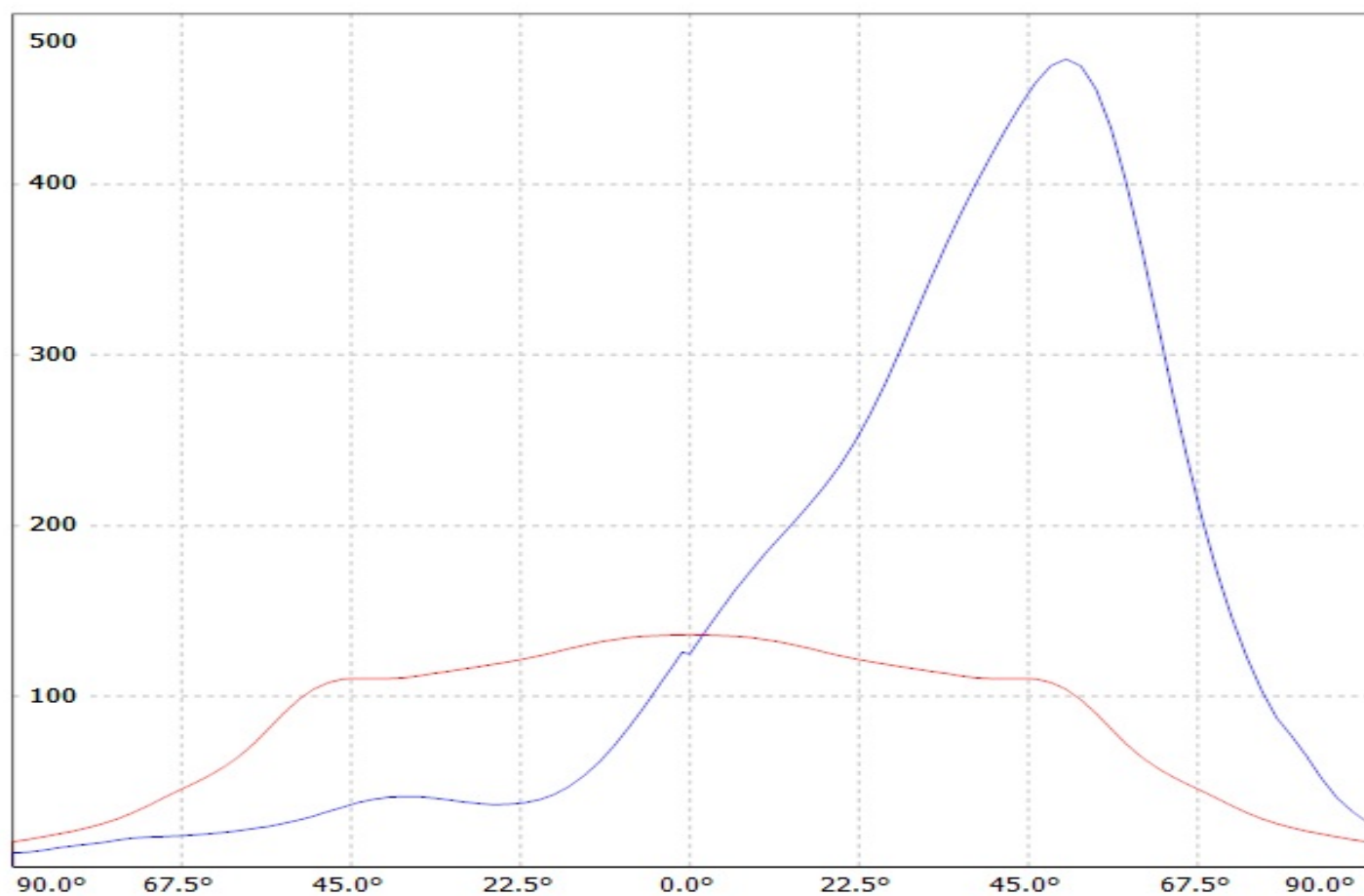

Luminaire: Ledil Oy CA12087-Strada-FW-Tape-XP
Lamps: 1 x Cree XP-E 74,6lm 250mA

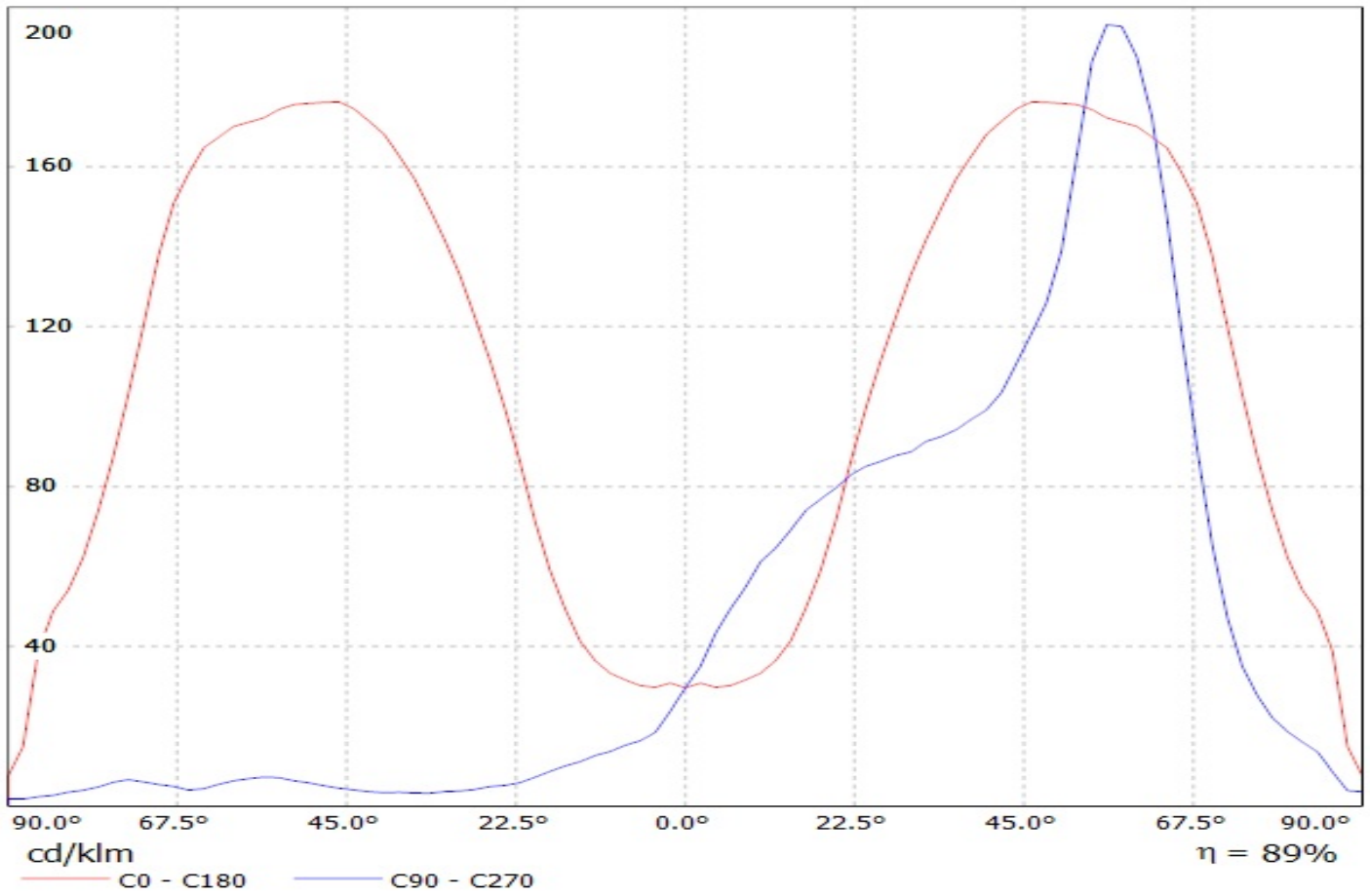

Luminaire: Ledil Oy C10818_Strada-A-XP C10818_Strada-A-XP
Lamps: 1 x Cree XP-E (white)

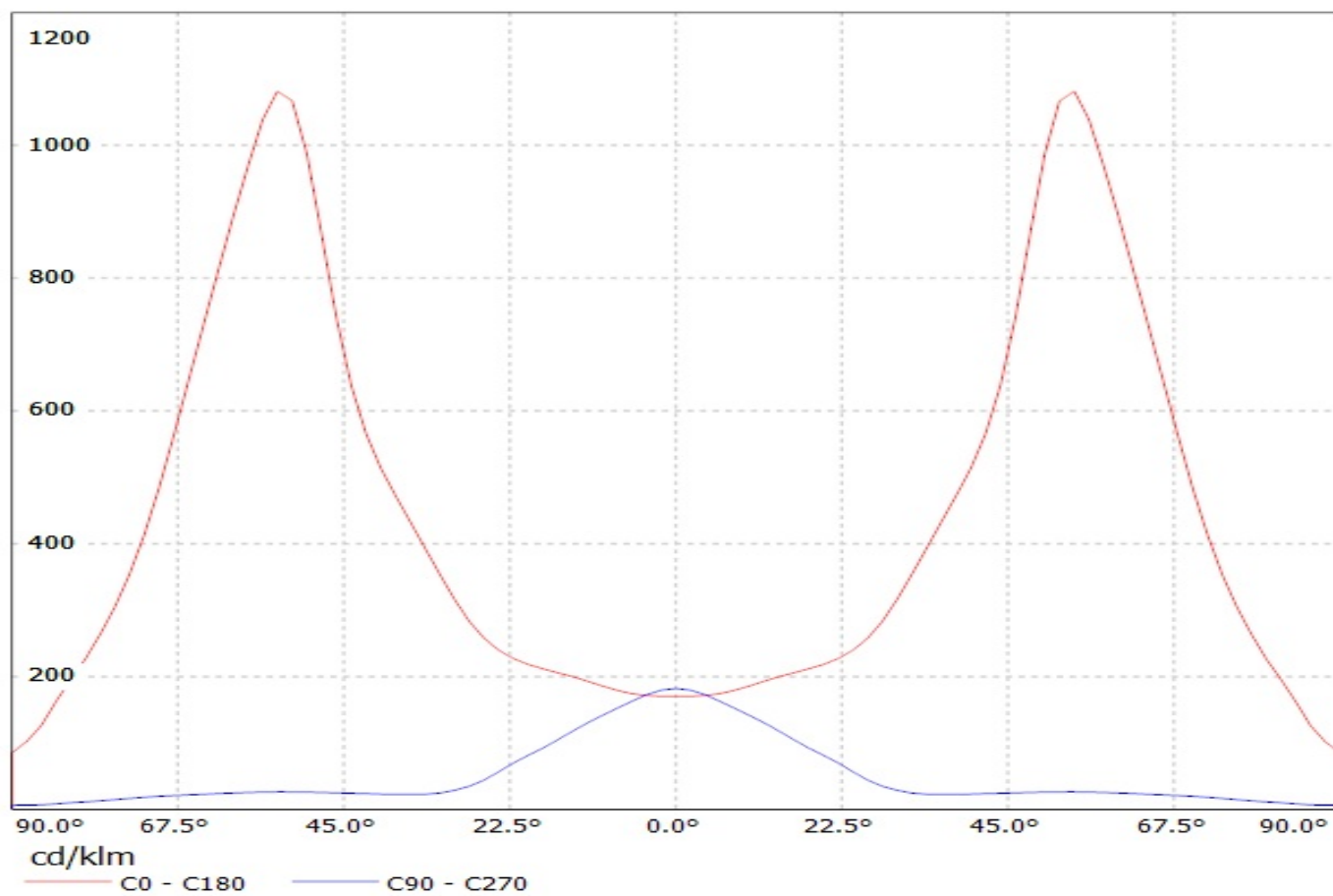

Luminaire: Ledil Oy CA10823_Strada-A-XP CA10823_Strada-A-XP
Lamps: 1 x Cree XP-E (white)

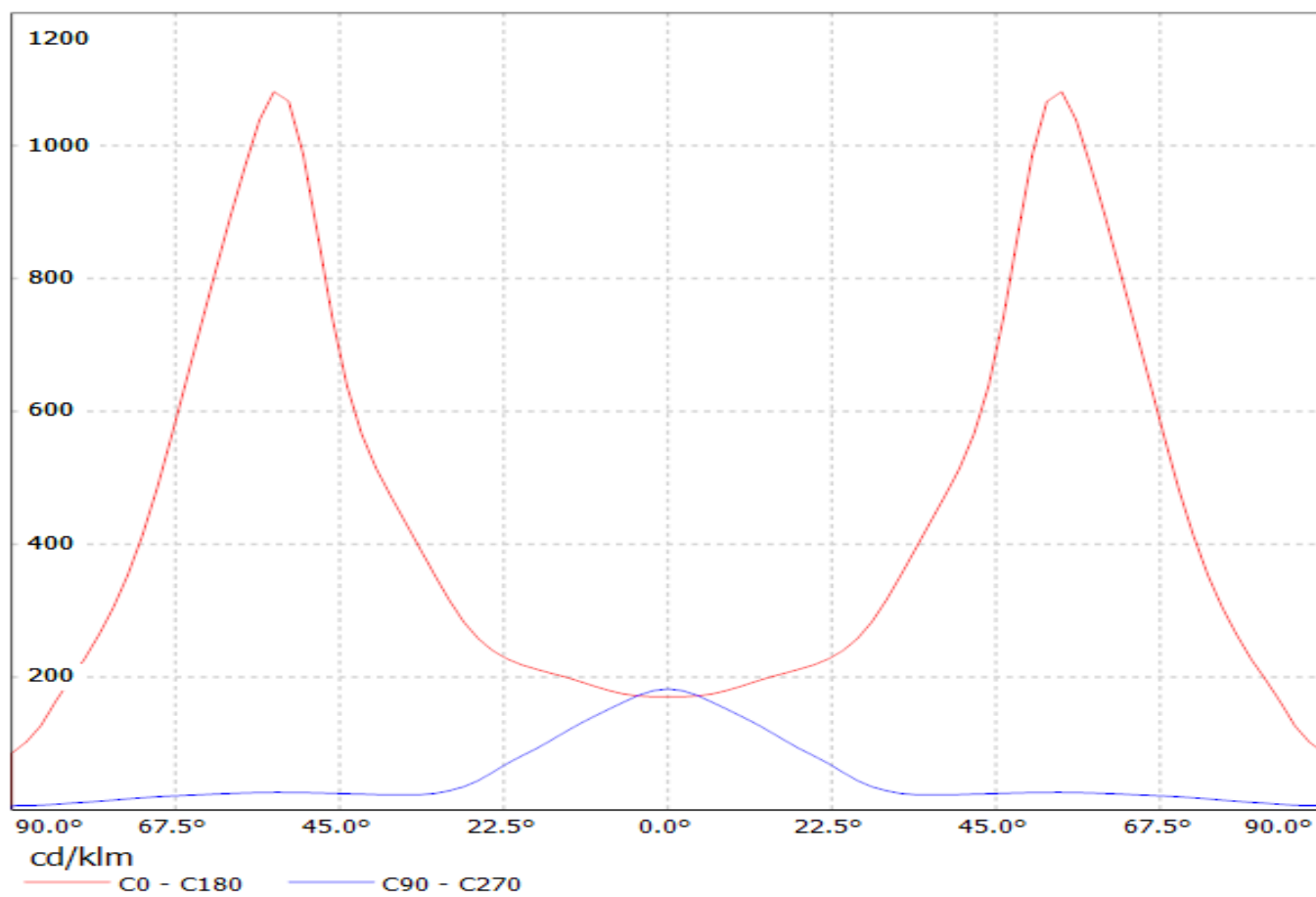

Ledil Oy C11255_Strada-DW-XP C11255_Strada-DW-XP / LDC (Linear)

Luminaire: Ledil Oy C11255_Strada-DW-XP C11255_Strada-DW-XP
Lamps: 1 x Cree XP-E (White)

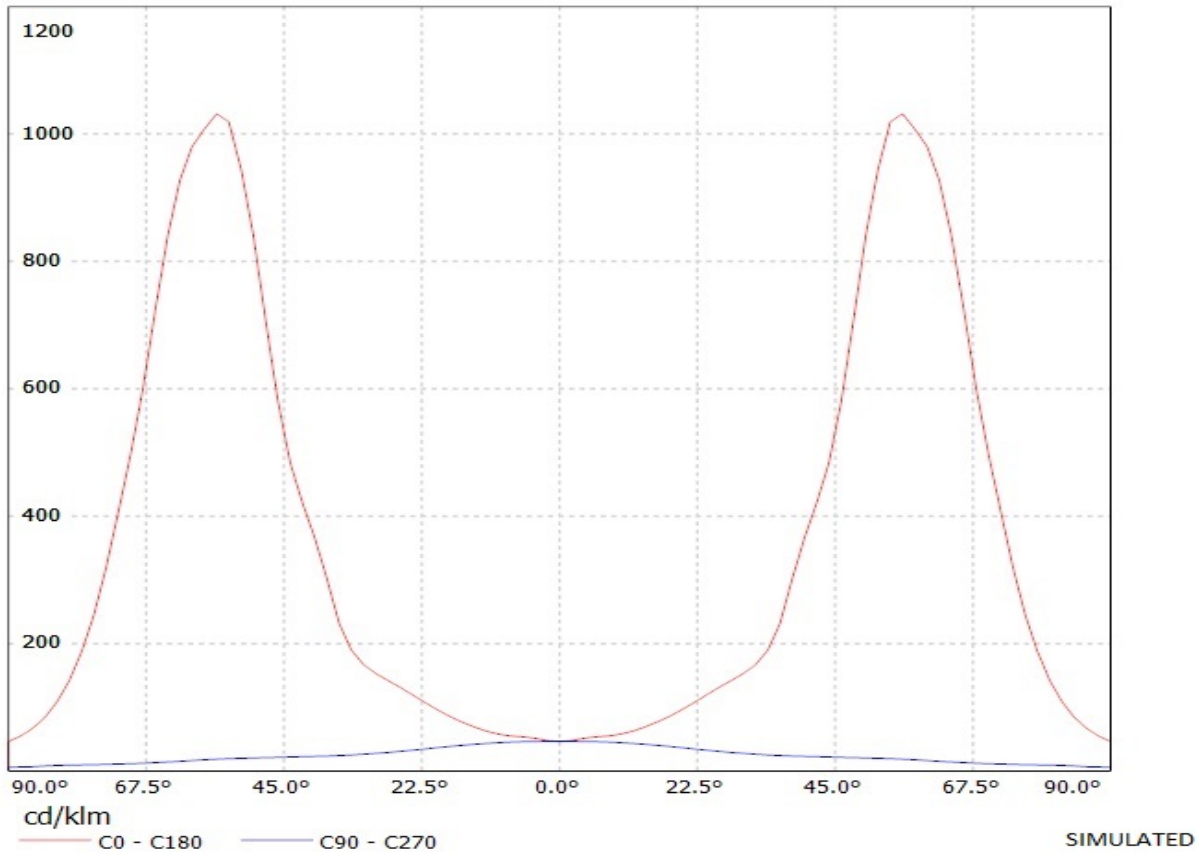

Ledil Oy C11255_Strada-DW-XP C11255_Strada-DW-XP / LDC (Linear)

Luminaire: Ledil Oy C11255_Strada-DW-XP C11255_Strada-DW-XP
Lamps: 1 x Cree XP-E (White)

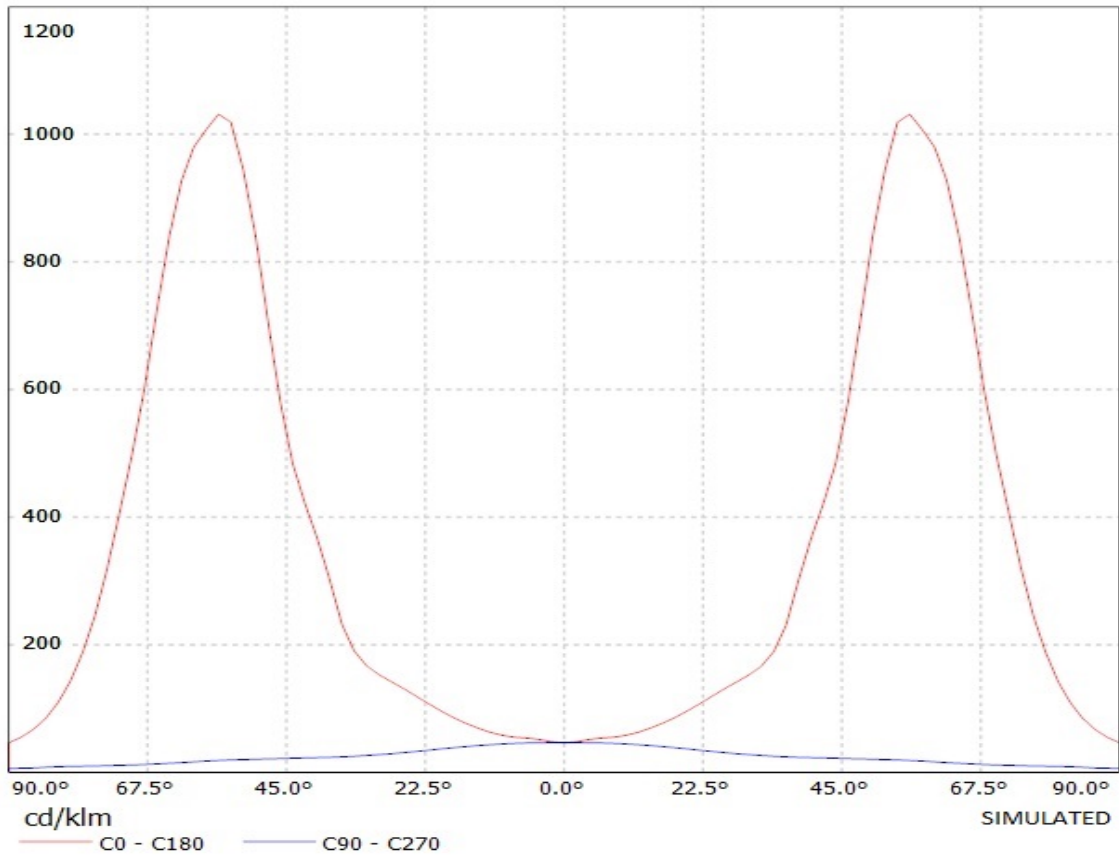

Ledil Oy C10926_Strada-B-XP C10926_Strada-B-XP / LDC (Linear)

Luminaire: Ledil Oy C10926_Strada-B-XP C10926_Strada-B-XP
Lamps: 1 x Cree XP-E (white)

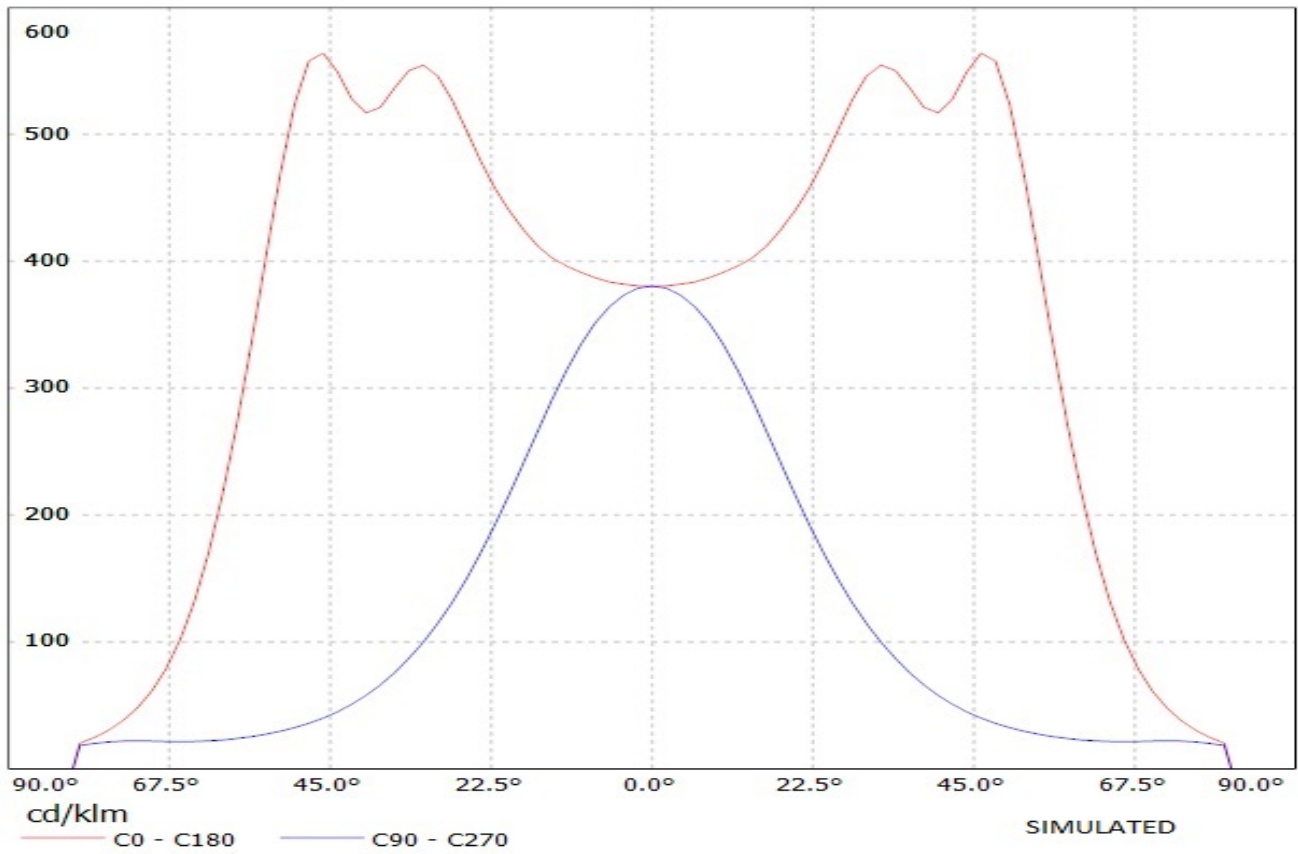

Ledil Oy C10926_Strada-B-XP C10926_Strada-B-XP / LDC (Linear)

Luminaire: Ledil Oy C10926_Strada-B-XP C10926_Strada-B-XP
Lamps: 1 x Cree XP-E (white)

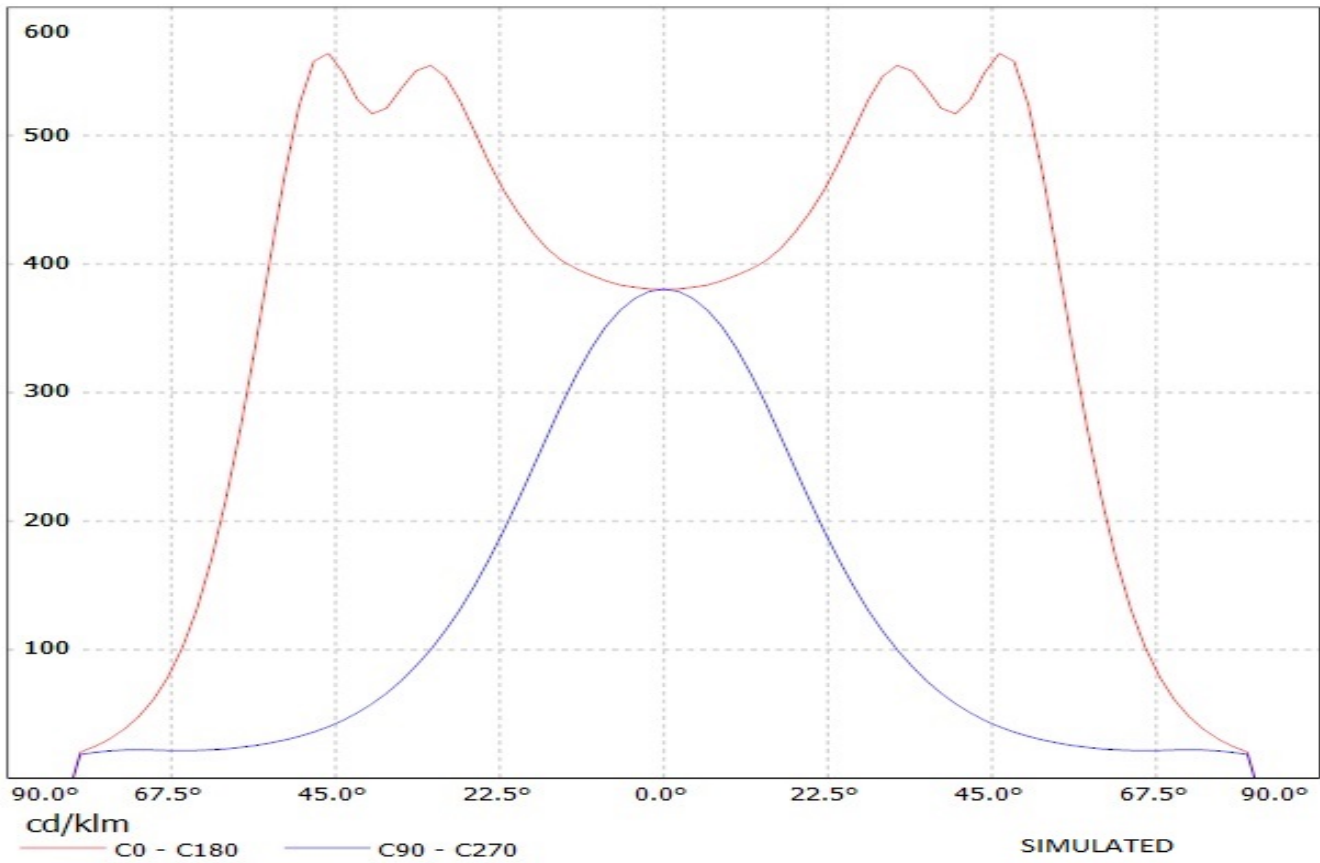

Ledil Oy C11252_Strada-C2-XP C11252_Strada-C2-XP / LDC (Linear)

Luminaire: Ledil Oy C11252_Strada-C2-XP C11252_Strada-C2-XP
Lamps: 1 x Cree XP-E (White)

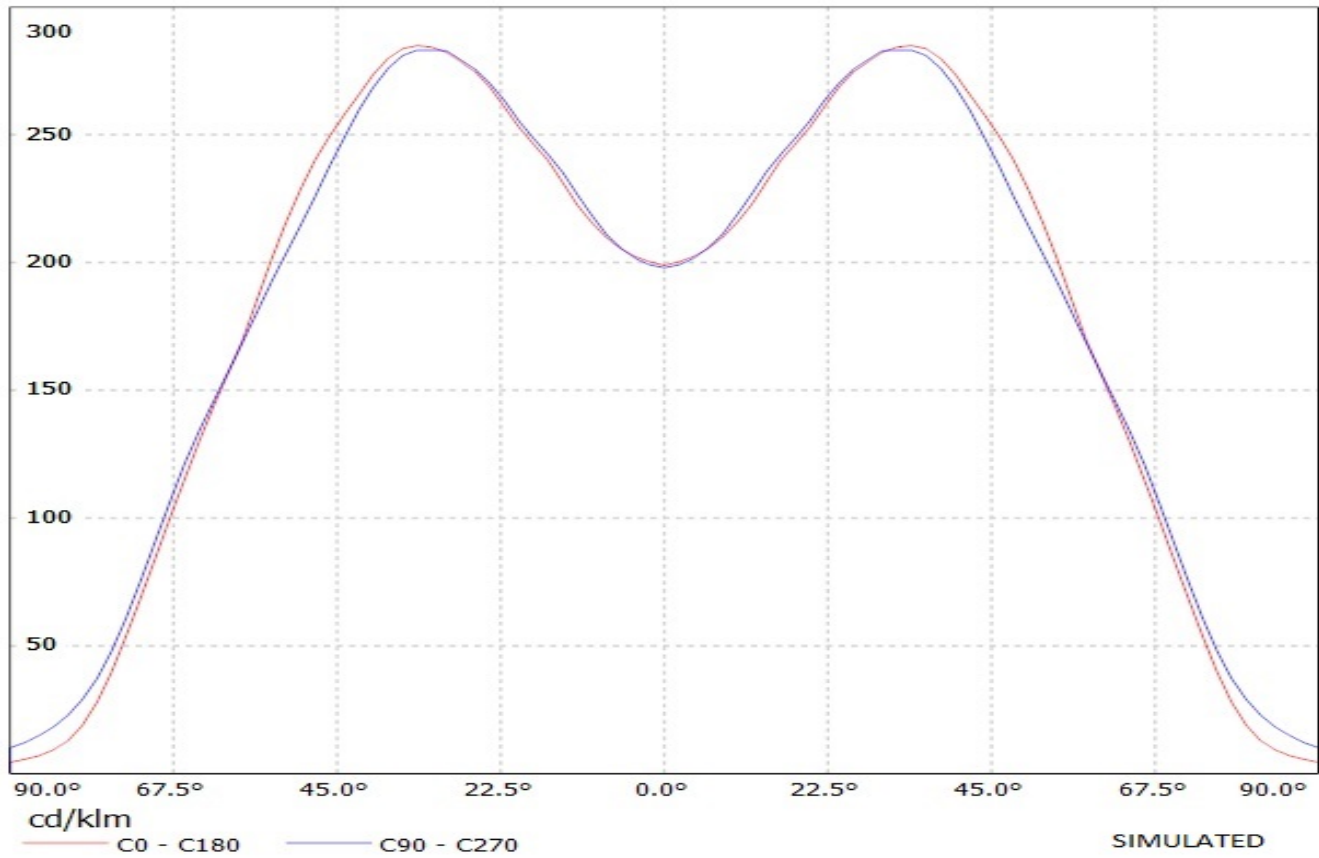

Ledil Oy C11249_Strada-S-XP C11249_Strada-S-XP / LDC (Linear)

Luminaire: Ledil Oy C11249_Strada-S-XP C11249_Strada-S-XP
Lamps: 1 x Cree XP-E (White)

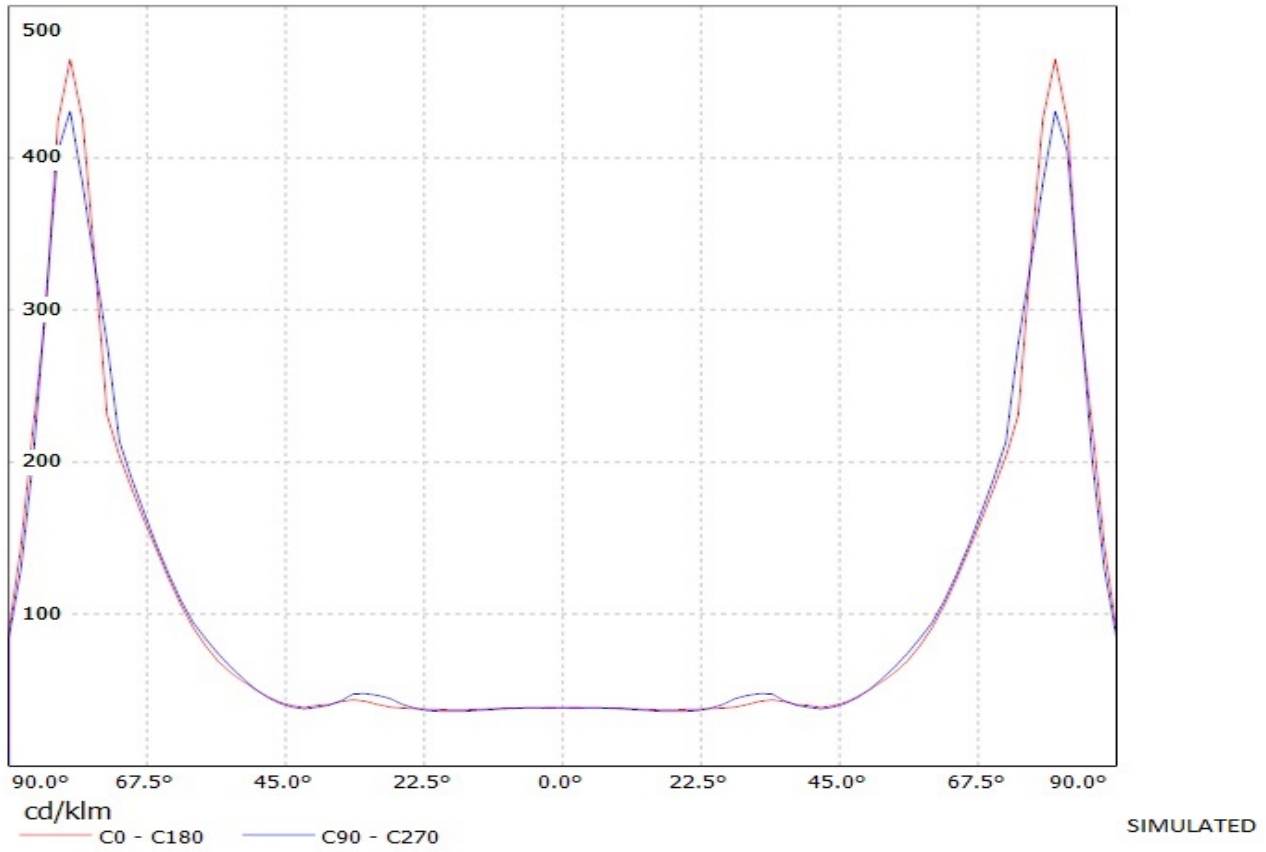

Ledil Oy C11249_Strada-S-XP C11249_Strada-S-XP / LDC (Linear)

Luminaire: Ledil Oy C11249_Strada-S-XP C11249_Strada-S-XP
Lamps: 1 x Cree XP-E (White)

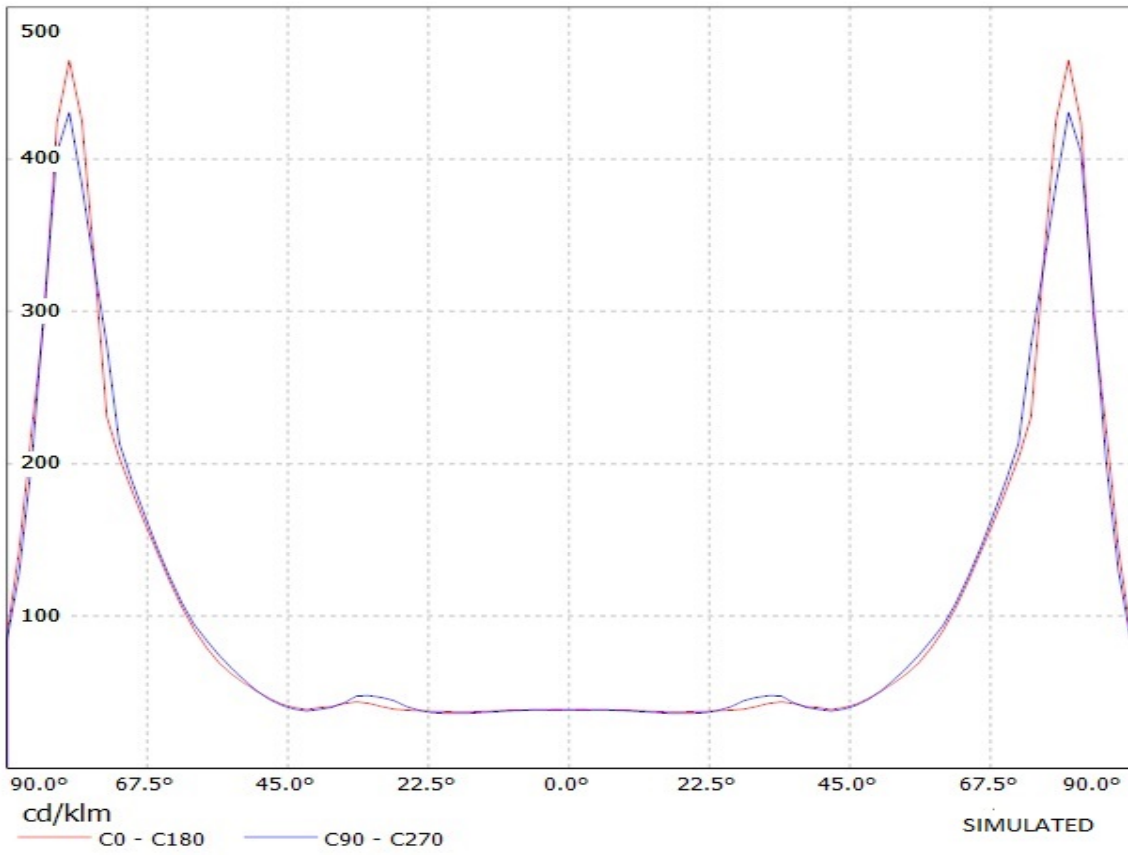

Ledil Oy C11415_Strada-T-DN-XP C11415_Strada-T-DN-XP / LDC (Polar)

Luminaire: Ledil Oy C11415_Strada-T-DN-XP C11415_Strada-T-DN-XP

Lamps: 1 x Cree XP-E (White)

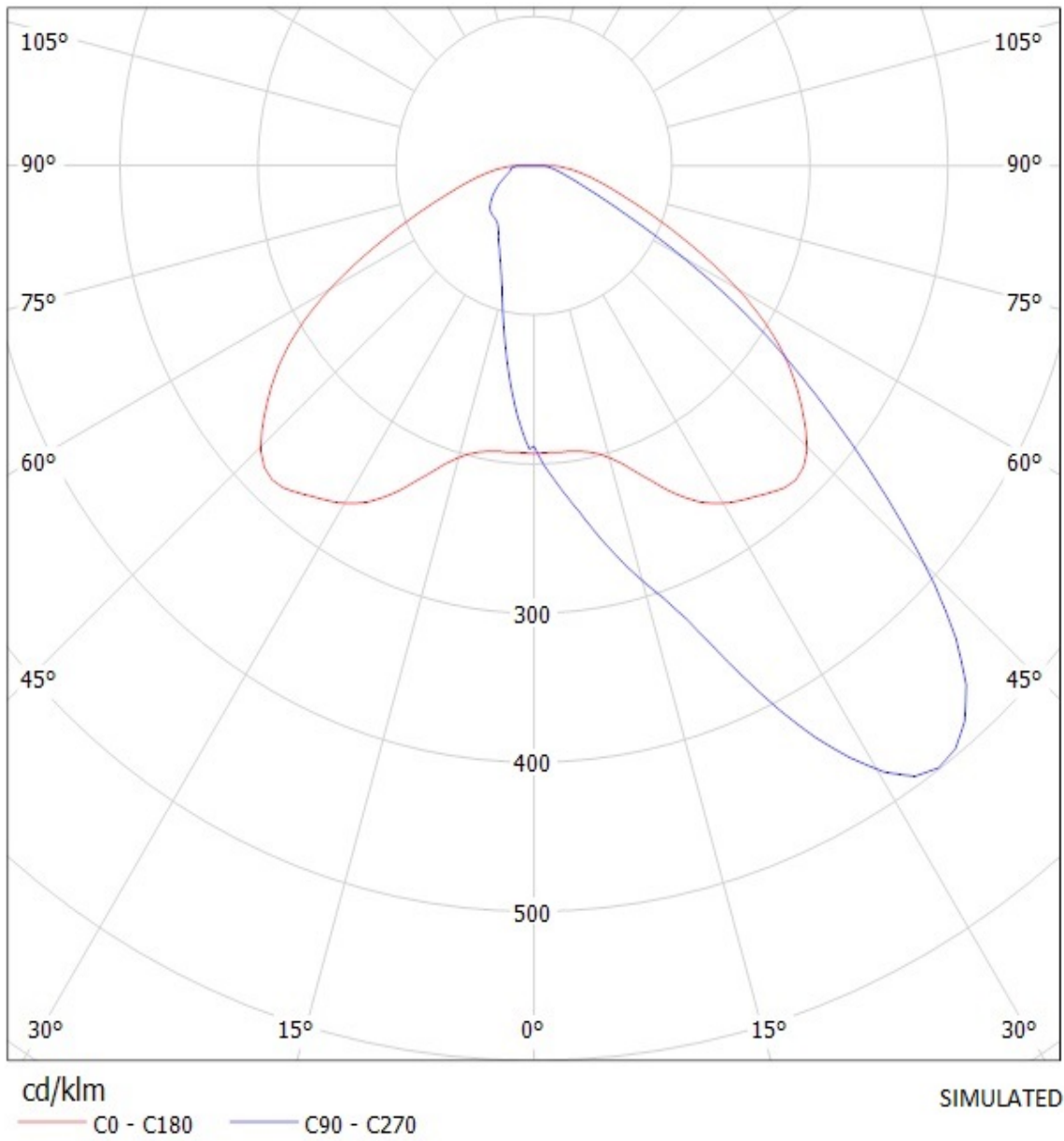

Ledil Oy C11415_Strada-T-DN-XP C11415_Strada-T-DN-XP / LDC (Polar)

Luminaire: Ledil Oy C11415_Strada-T-DN-XP C11415_Strada-T-DN-XP

Lamps: 1 x Cree XP-E (White)

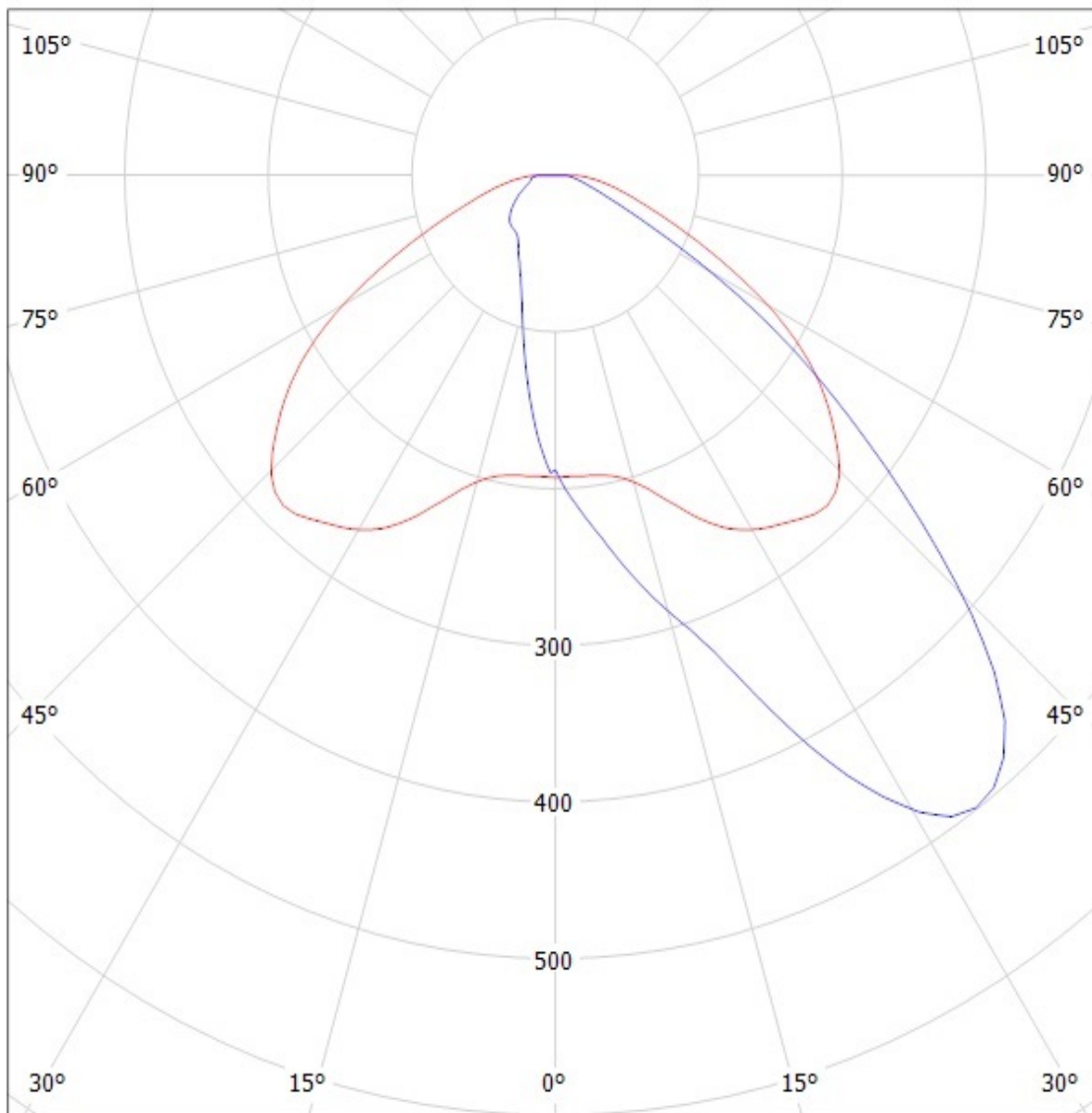

cd/klm

— C0 - C180

— C90 - C270

SIMULATED

Ledil Oy C11425_Strada-T-DW-XP C11425_Strada-T-DW-XP / LDC (Polar)

Luminaire: Ledil Oy C11425_Strada-T-DW-XP C11425_Strada-T-DW-XP

Lamps: 1 x Cree XP-E (White)

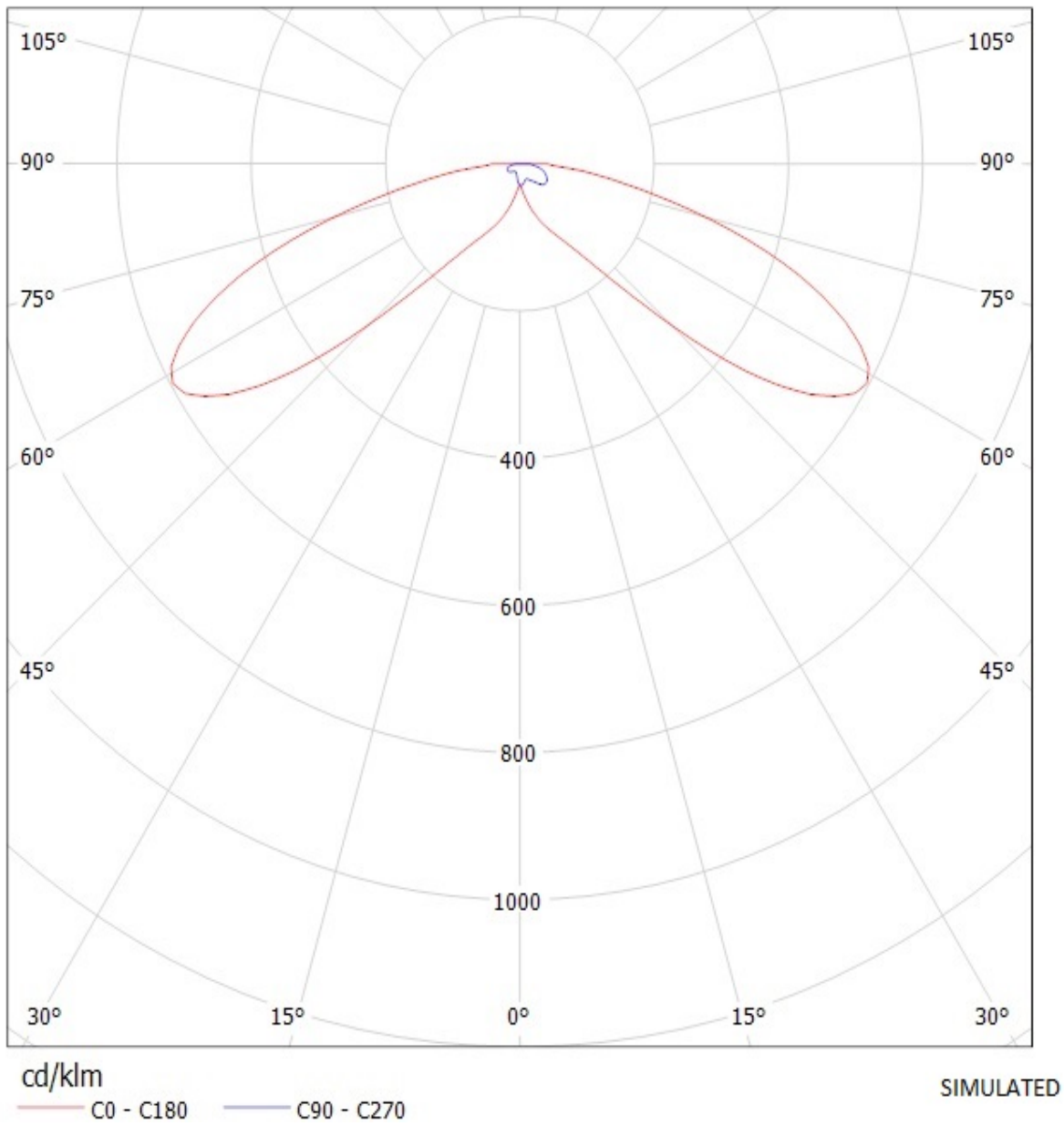

Ledil Oy C11425_Strada-T-DW-XP C11425_Strada-T-DW-XP / LDC (Polar)

Luminaire: Ledil Oy C11425_Strada-T-DW-XP C11425_Strada-T-DW-XP
Lamps: 1 x Cree XP-E (White)

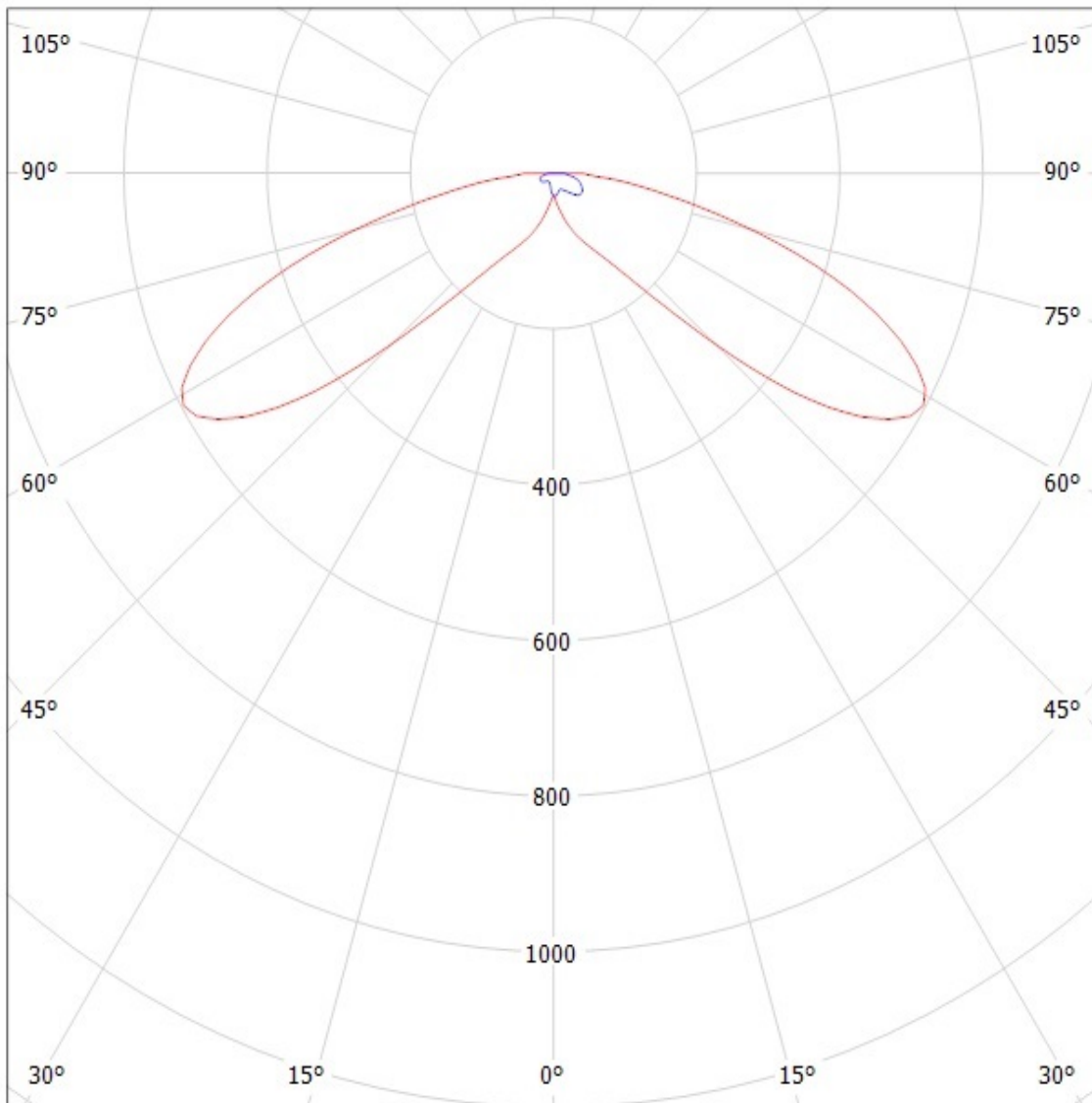

cd/km

— C0 - C180 — C90 - C270

SIMULATED

Ledil Oy C11415_Strada-T-DN-XP C11415_Strada-T-DN-XP / LDC (Polar)

Luminaire: Ledil Oy C11415_Strada-T-DN-XP C11415_Strada-T-DN-XP

Lamps: 1 x Cree XP-E (White)

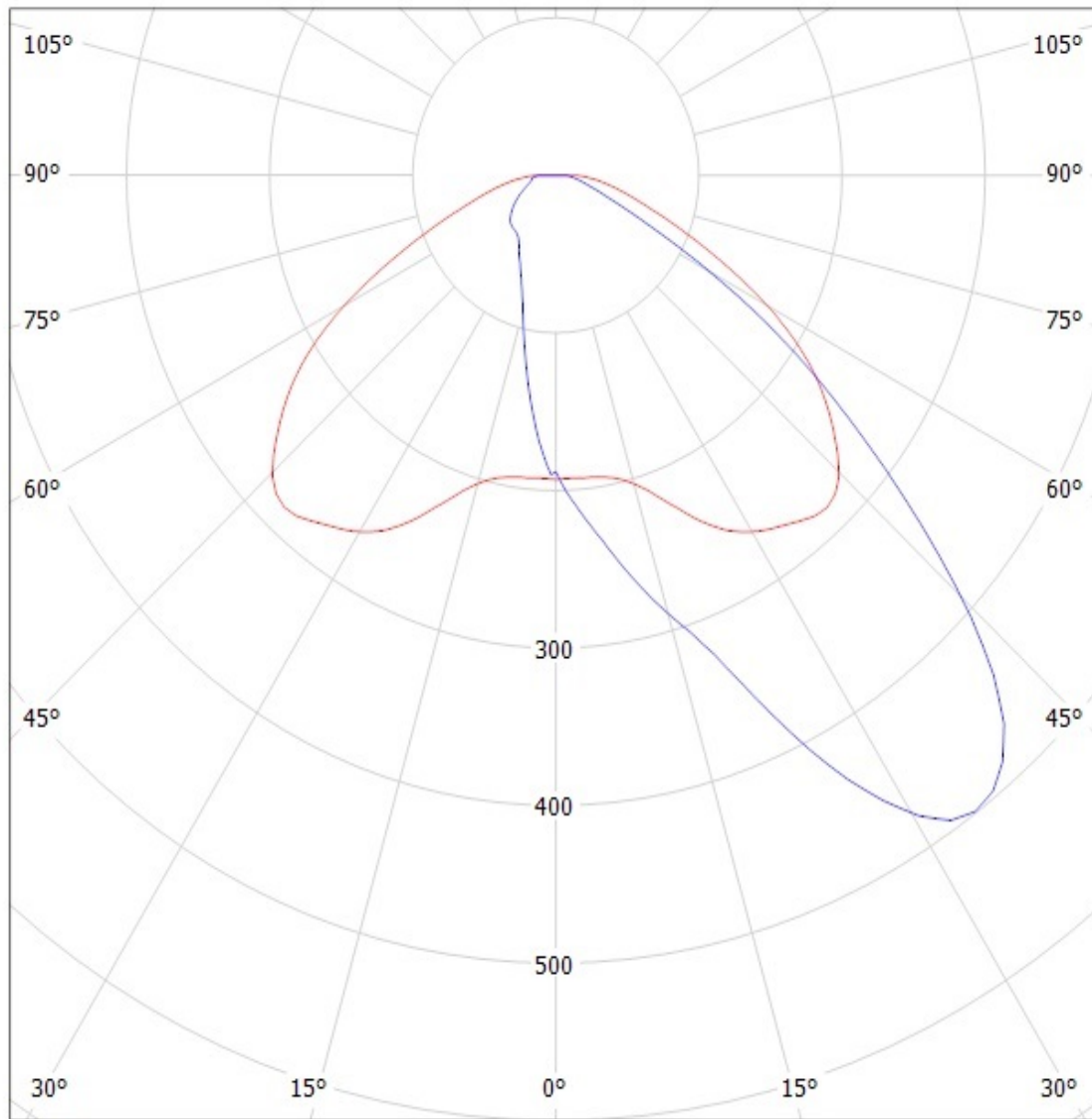

cd/klm

— C0 - C180

— C90 - C270

SIMULATED

Ledil Oy C11425_Strada-T-DW-XP C11425_Strada-T-DW-XP / LDC (Polar)

Luminaire: Ledil Oy C11425_Strada-T-DW-XP C11425_Strada-T-DW-XP

Lamps: 1 x Cree XP-E (White)

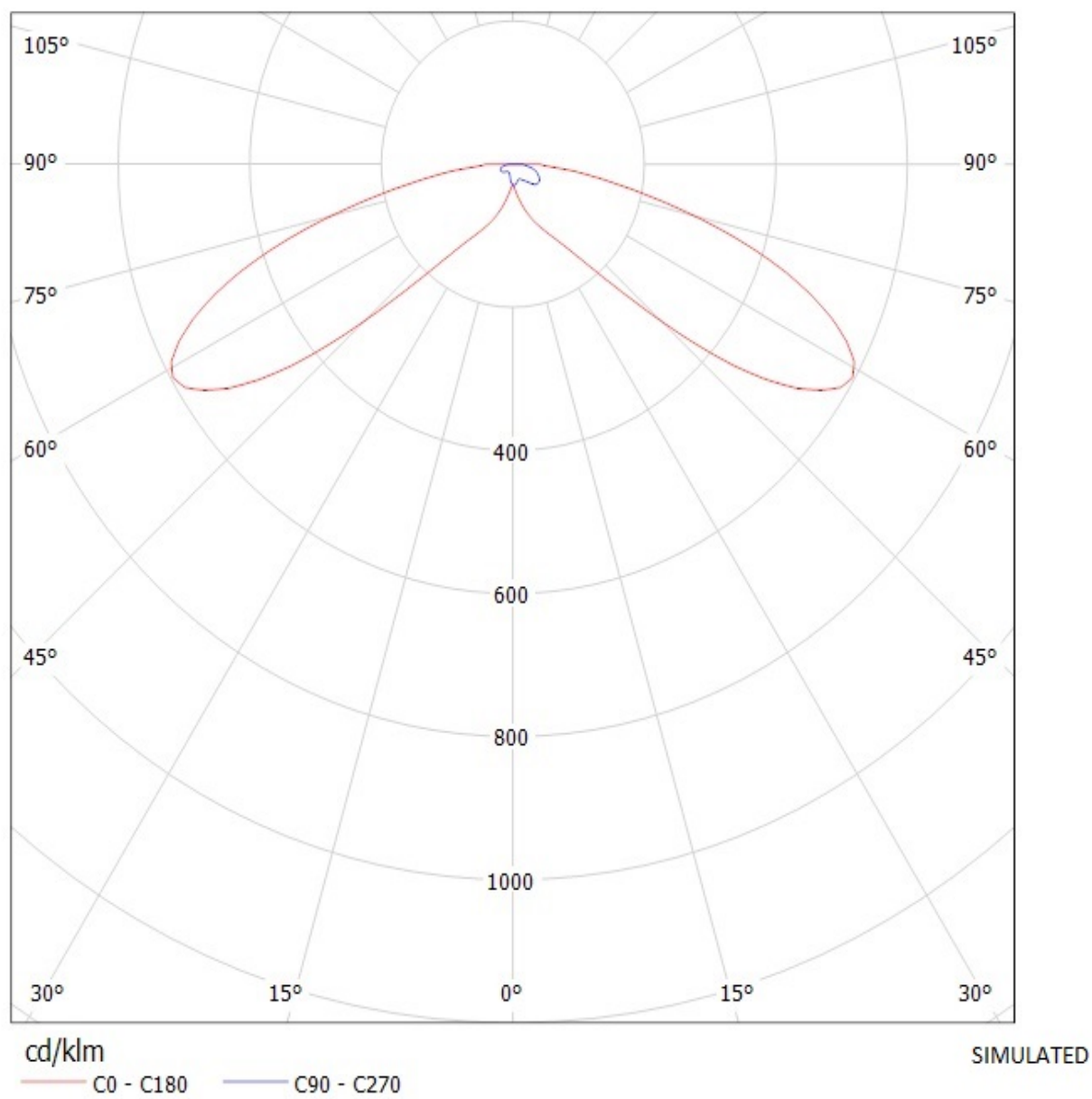

Ledil Oy C11415_Strada-T-DN-XP C11415_Strada-T-DN-XP / LDC (Polar)

Luminaire: Ledil Oy C11415_Strada-T-DN-XP C11415_Strada-T-DN-XP

Lamps: 1 x Cree XP-E (White)

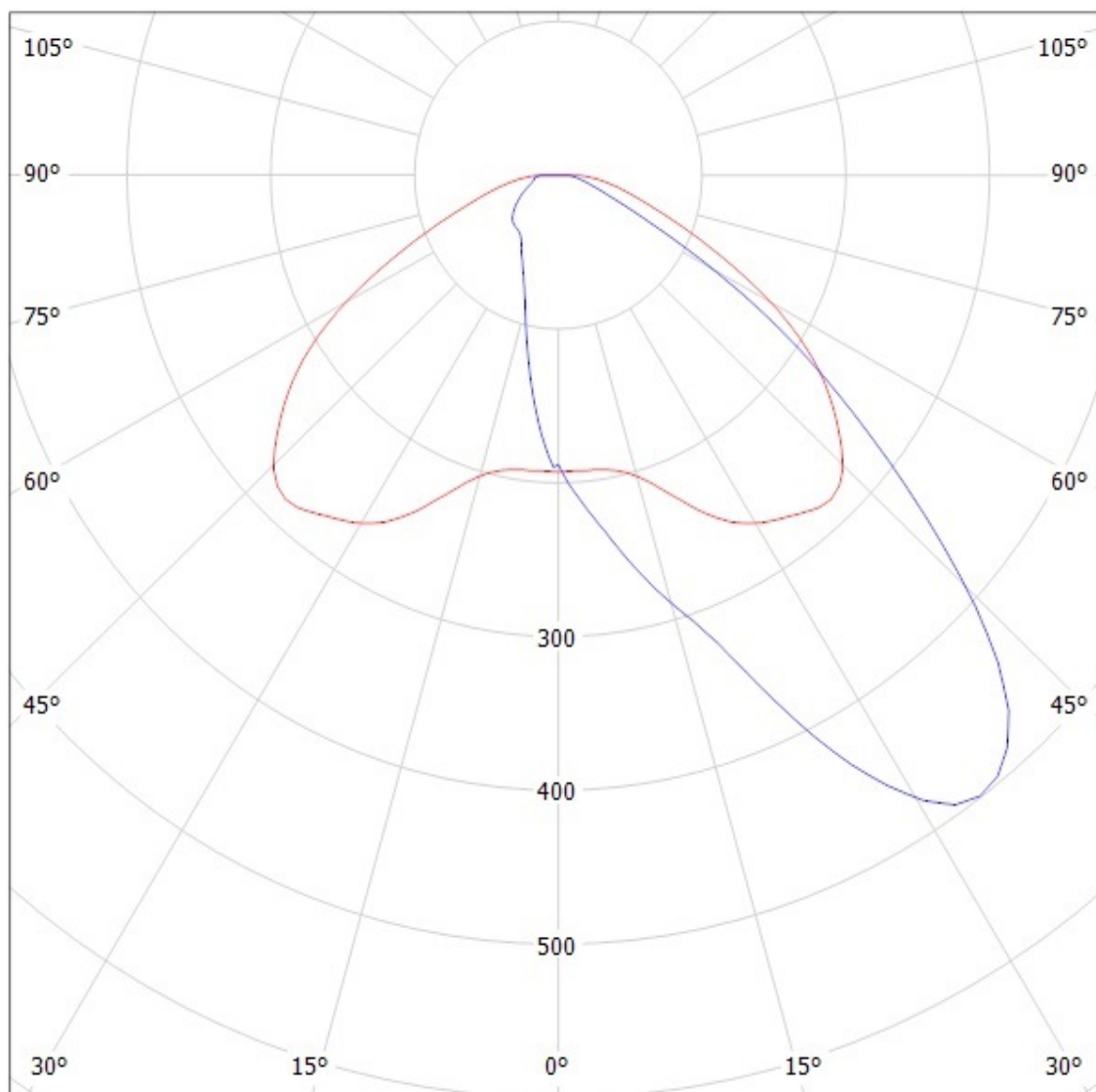

cd/klm

— C0 - C180

— C90 - C270

SIMULATED

Ledil Oy C11425_Strada-T-DW-XP C11425_Strada-T-DW-XP / LDC (Polar)

Luminaire: Ledil Oy C11425_Strada-T-DW-XP C11425_Strada-T-DW-XP
Lamps: 1 x Cree XP-E (White)

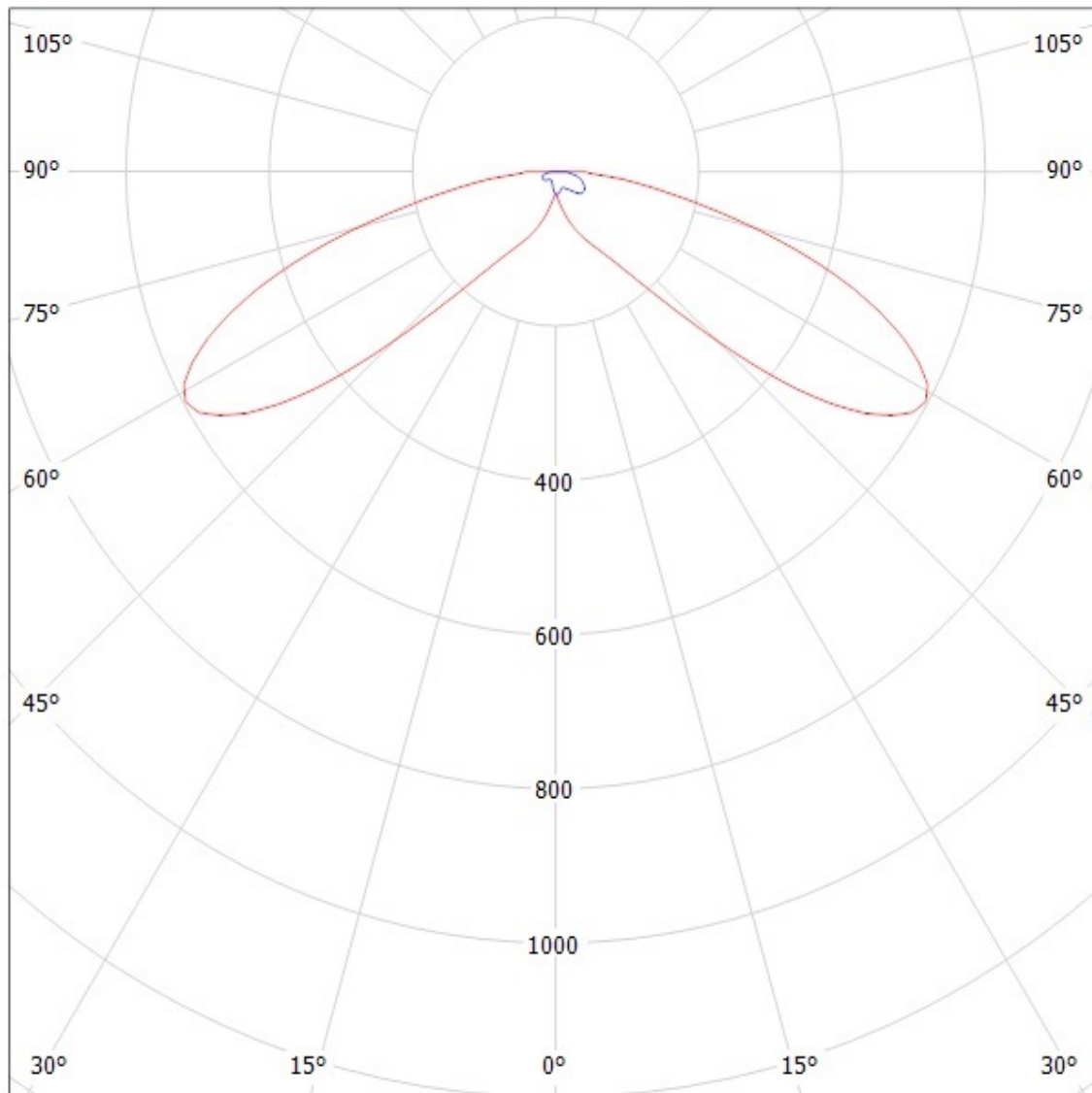

cd/klm

— C0 - C180 — C90 - C270

SIMULATED

Luminaire: Ledil Oy C12049_Strada-FT-XP C12049_Strada-FT-XP
Lamps: 1 x Cree XP-E

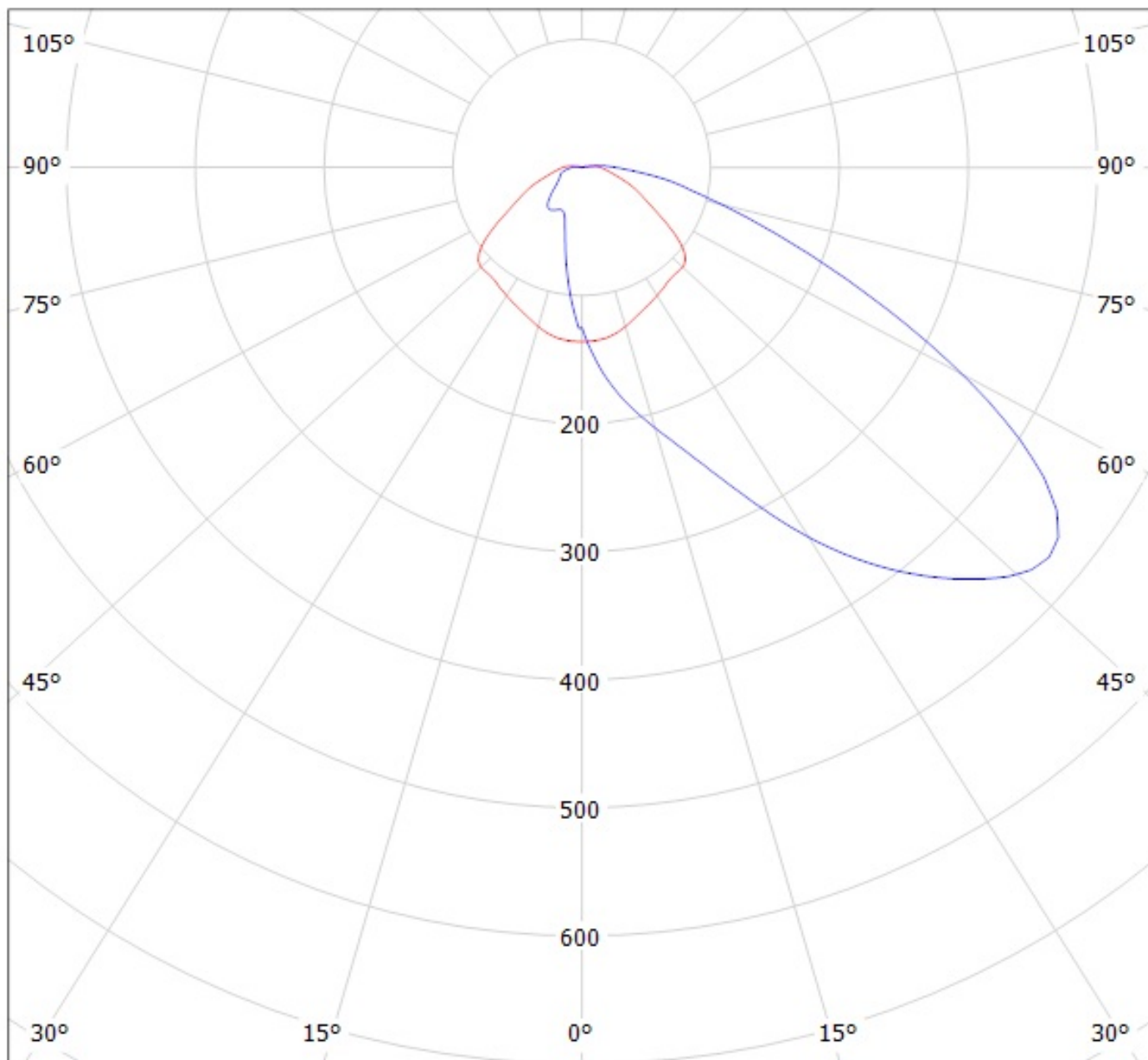

Luminaire: Ledil Oy CA12087-Strada-FW-Tape-XP
Lamps: 1 x Cree XP-E 74,6lm 250mA

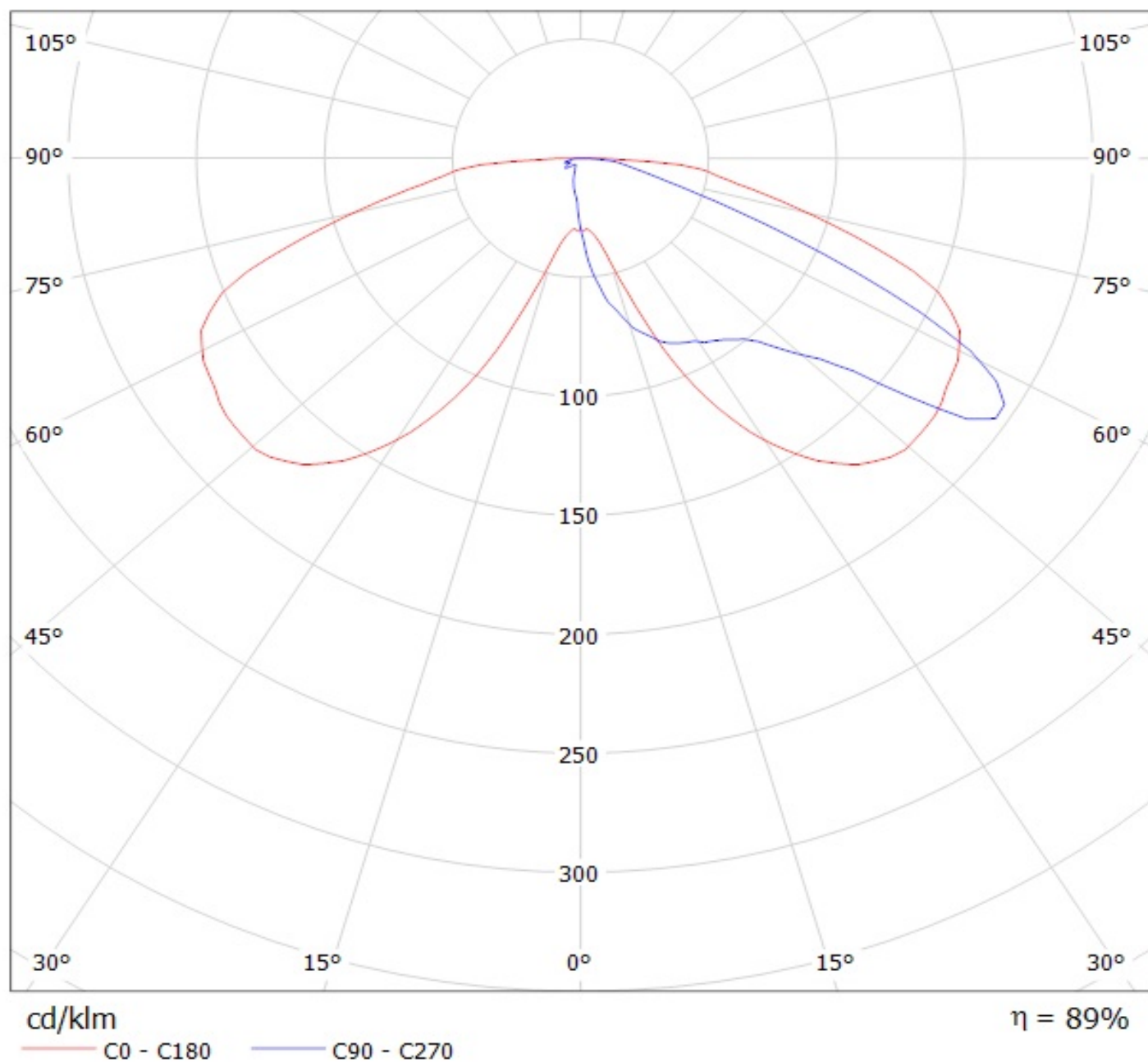

Luminaire: Ledil Oy CA10823_Strada-A-XP CA10823_Strada-A-XP
Lamps: 1 x Cree XP-E (white)

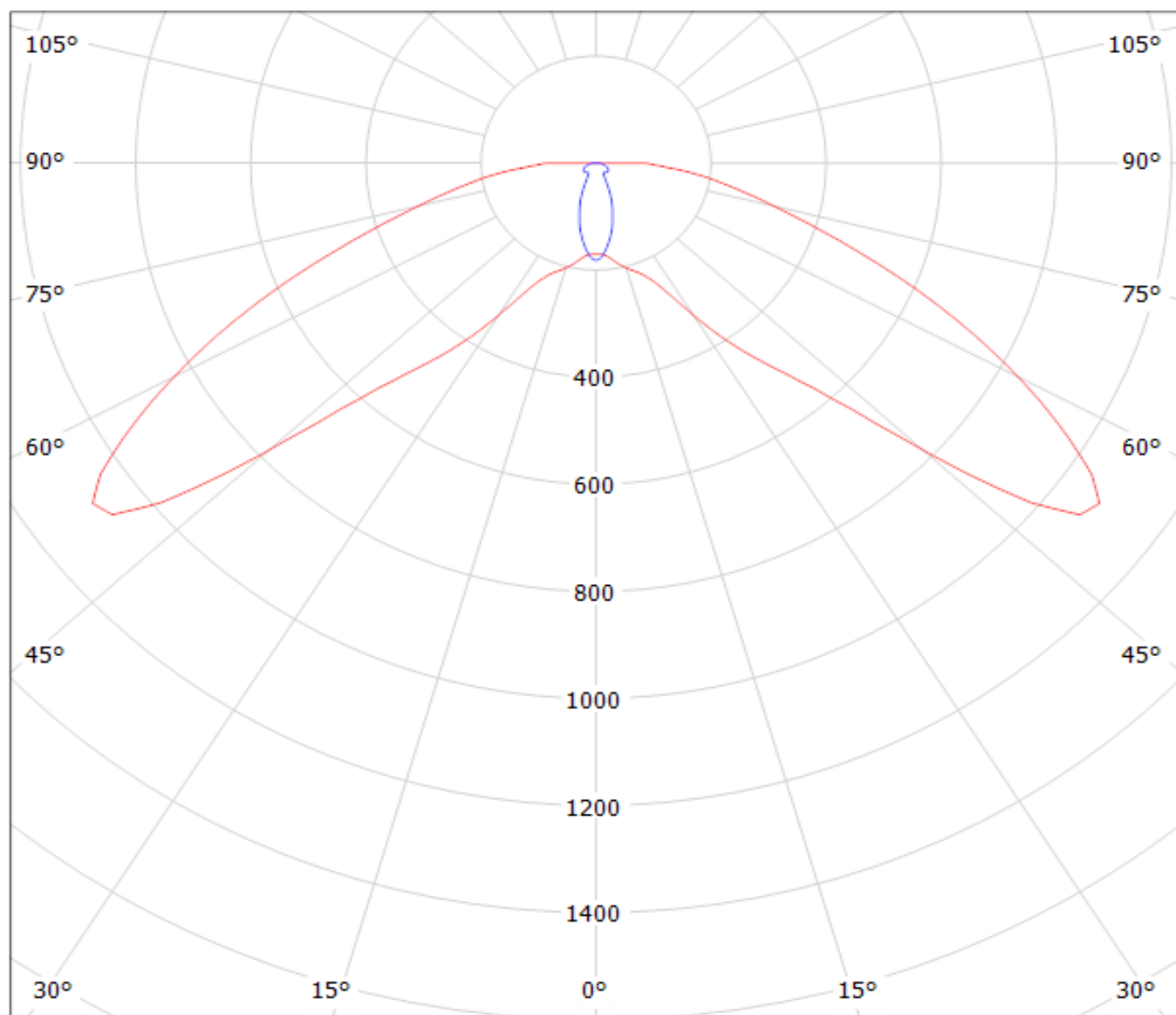

cd/klm

— C0 - C180

— C90 - C270

Ledil Oy C11255_Strada-DW-XP C11255_Strada-DW-XP / LDC (Polar)

Luminaire: Ledil Oy C11255_Strada-DW-XP C11255_Strada-DW-XP

Lamps: 1 x Cree XP-E (White)

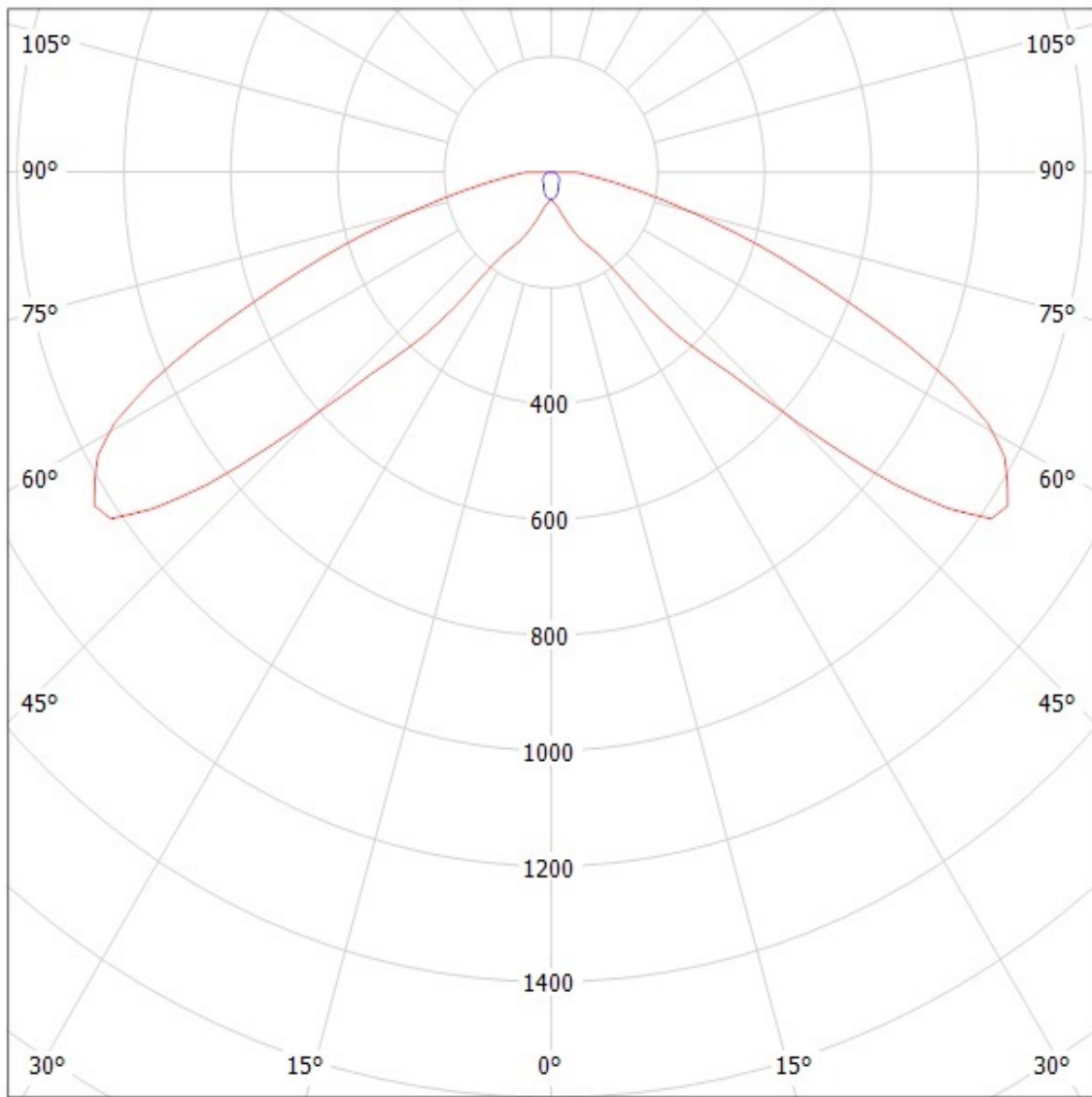

cd/klm

— C0 - C180

— C90 - C270

SIMULATED

Ledil Oy C11255_Strada-DW-XP C11255_Strada-DW-XP / LDC (Polar)

Luminaire: Ledil Oy C11255_Strada-DW-XP C11255_Strada-DW-XP
Lamps: 1 x Cree XP-E (White)

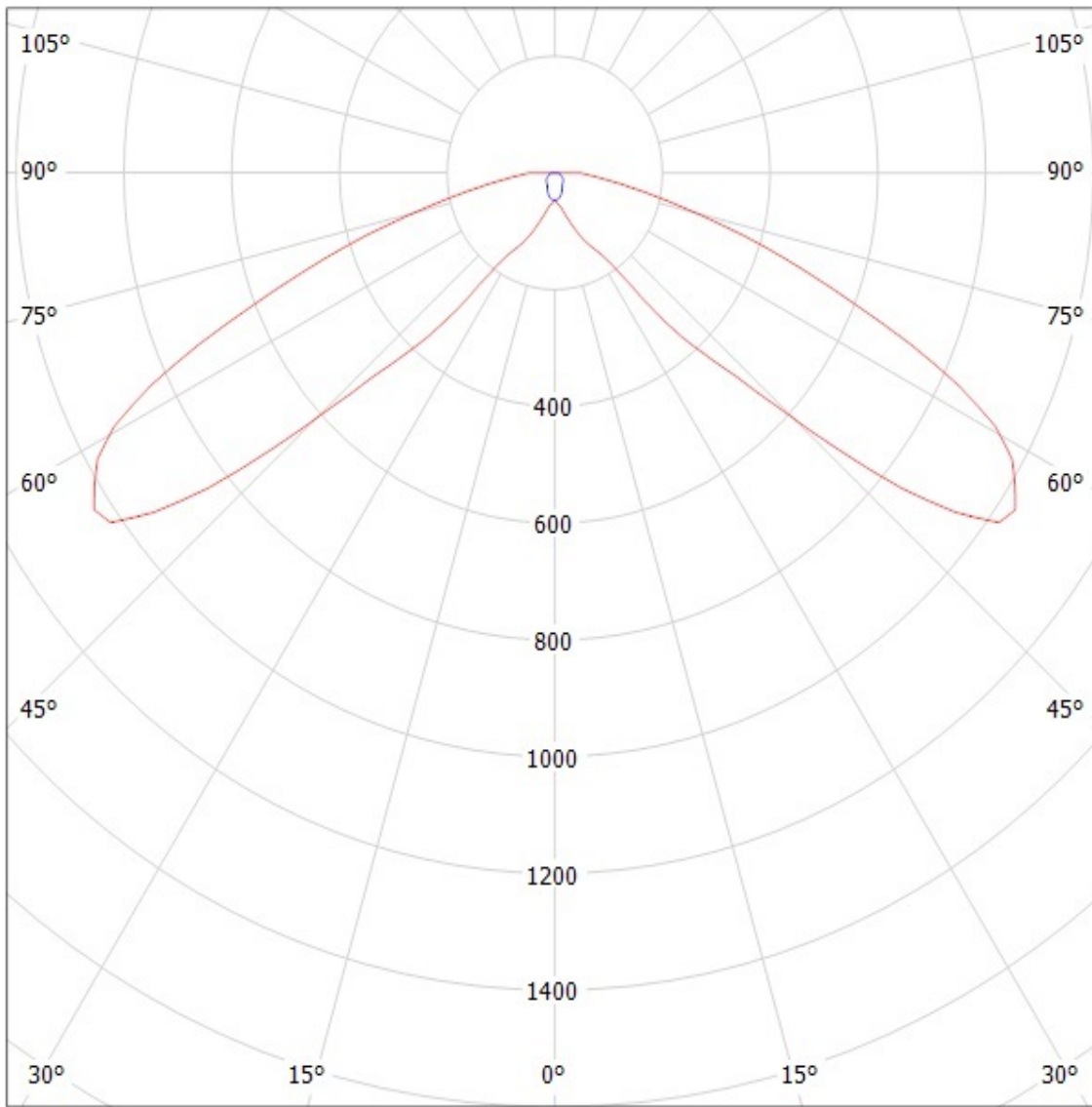

cd/klm

— C0 - C180 — C90 - C270

SIMULATED

Ledil Oy C10926_Strada-B-XP C10926_Strada-B-XP / LDC (Polar)

Luminaire: Ledil Oy C10926_Strada-B-XP C10926_Strada-B-XP
Lamps: 1 x Cree XP-E (white)

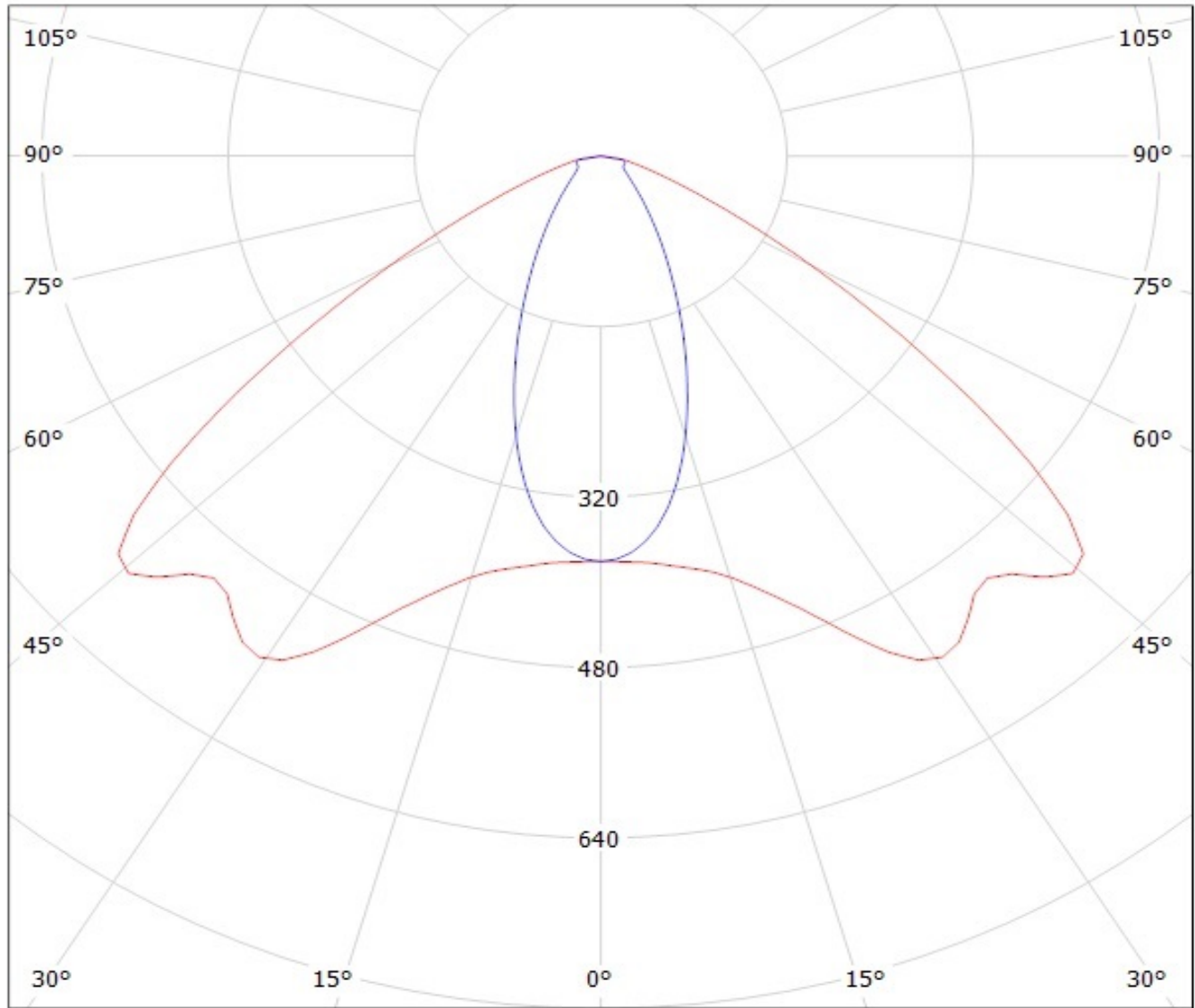

cd/klm

— C0 - C180

— C90 - C270

SIMULATED

Ledil Oy C10926_Strada-B-XP C10926_Strada-B-XP / LDC (Polar)

Luminaire: Ledil Oy C10926_Strada-B-XP C10926_Strada-B-XP

Lamps: 1 x Cree XP-E (white)

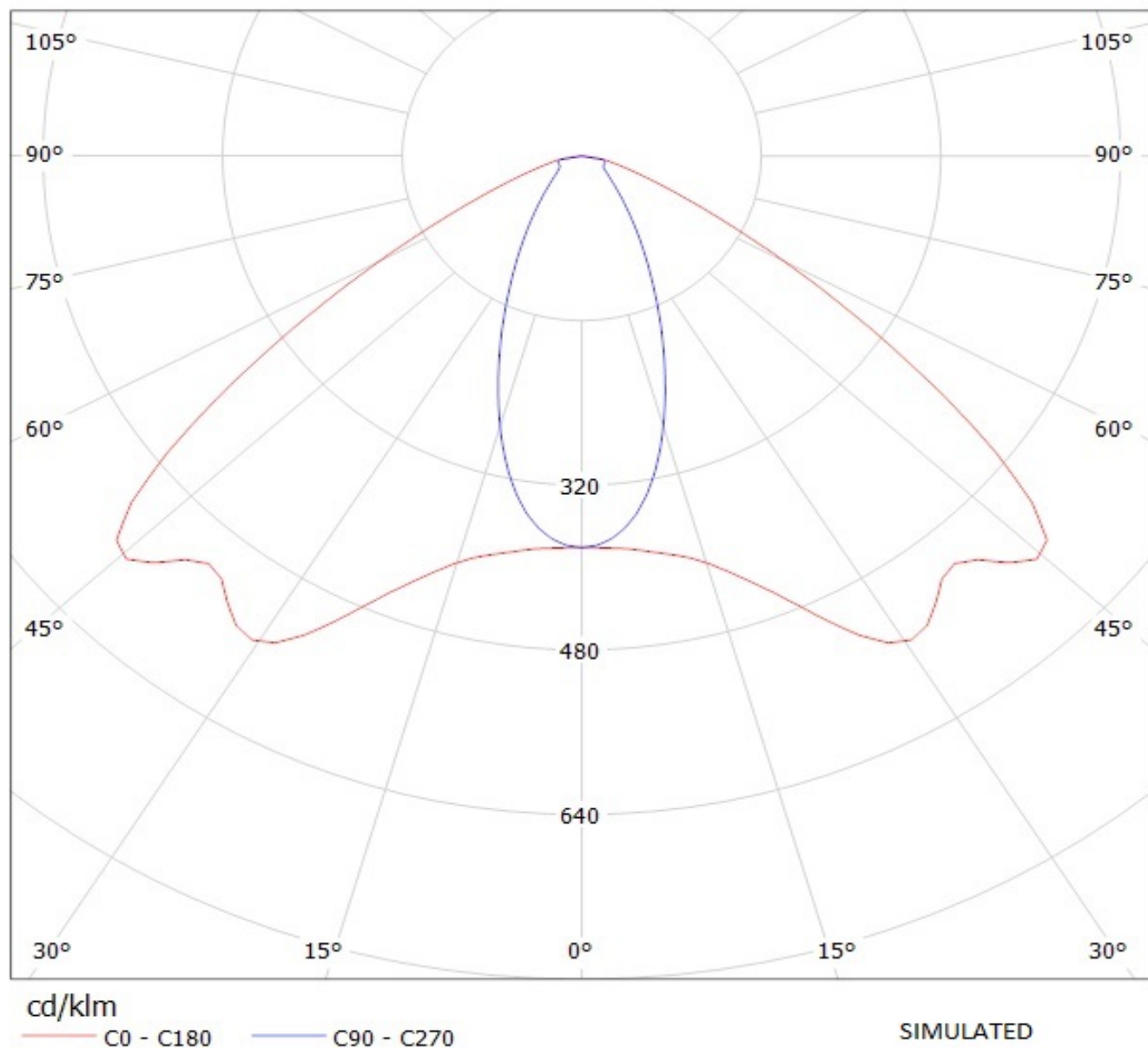

Ledil Oy C11252_Strada-C2-XP C11252_Strada-C2-XP / LDC (Polar)

Luminaire: Ledil Oy C11252_Strada-C2-XP C11252_Strada-C2-XP
Lamps: 1 x Cree XP-E (White)

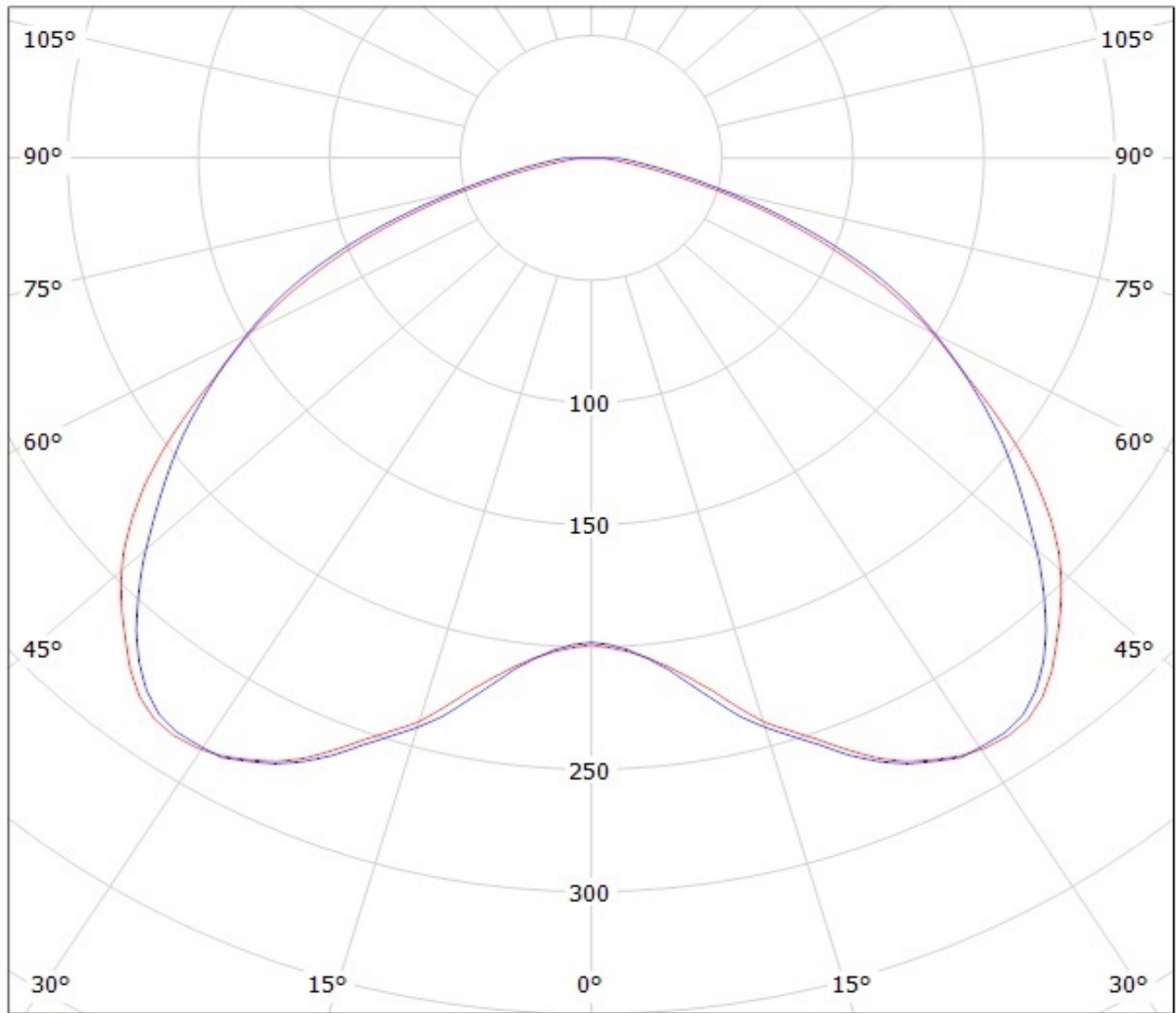

cd/klm

— C0 - C180

— C90 - C270

SIMULATED

Ledil Oy C11249_Strada-S-XP C11249_Strada-S-XP / LDC (Polar)

Luminaire: Ledil Oy C11249_Strada-S-XP C11249_Strada-S-XP

Lamps: 1 x Cree XP-E (White)

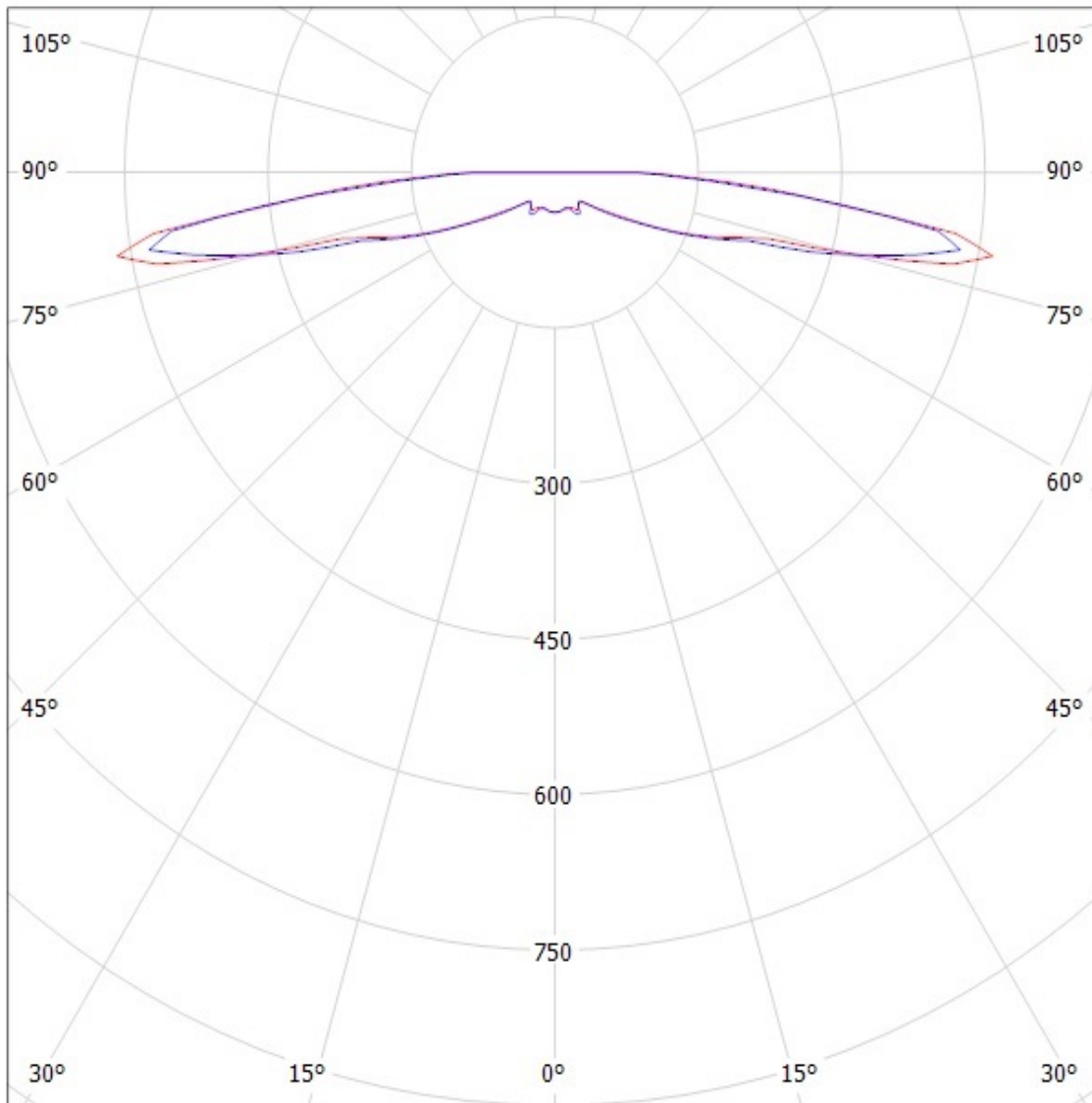

cd/klm

— C0 - C180 — C90 - C270

SIMULATED

Ledil Oy C11249_Strada-S-XP C11249_Strada-S-XP / LDC (Polar)

Luminaire: Ledil Oy C11249_Strada-S-XP C11249_Strada-S-XP

Lamps: 1 x Cree XP-E (White)

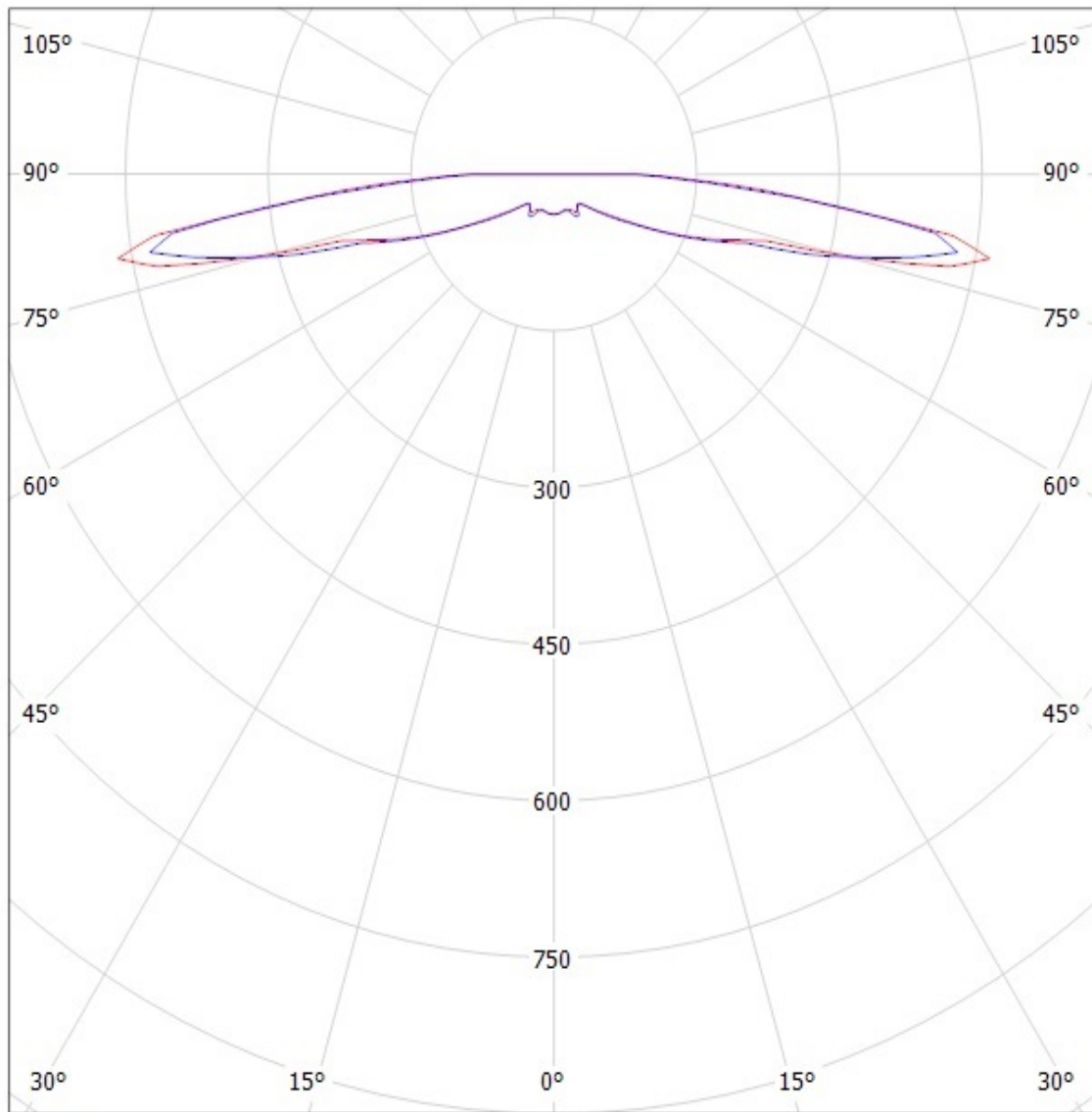

cd/klm

— C0 - C180 — C90 - C270

SIMULATED