



金龙机电股份有限公司
JINLONG MACHINERY & ELECTRONICS CO., LTD.
 www.jinlong-machinery.com
 sales@jinlong-machinery.com

规格书

SPECIFICATION

客户信息	客户名称/Customer	
	客户料号/Part No.	
	客户承认签章 Customer Approved Signatures	

文件编号/Spec No.	KOTL-B-799	
品名/Description	圆柱直流马达/Cylindrical DC motor	
型号/Part No.	Z4TH5B1241992	
设计/Designed	审核/Checked	批准/Approved
		
2009.09.16	2009.09.16	2009.09.16

规格书内容/Contents

1、适用范围/ General Scope	3/9
2、使用条件/ Operating Conditions	3/9
3、测定条件/ Measuring Conditions	3/9
4、机械要求/ Mechanical Specifications	3/9
5、性能特征/Performance and characteristics	4/9
6、可靠性/Reliability	5/9
7、要求/Requirements	6/9
8、使用时注意事项/ attentions	6/9
9、包装/Packaging	7/9
10、外形图/Outline Drawing	8/9
11、修改记录 / REVISION HISTORY	9/9

型号/Part No.	Z4TH5B1241992
-------------	---------------

1. 适用范围/General Scope
 本说明书适用于圆筒式永磁直流电机 Z4TH5B1241992 型
 This specification applies to cylindrical permanent-magnetic motors DC model Z4TH5B1241992.

2. 使用条件/Operating Conditions

项目/Item	规格/Specifications	条件·备注/Conditions & Remarks
2-1 额定电压 Rated voltage	3.0V DC	
2-2 额定负荷 Rated load	振子 Counterweight	见 10. 外形图 As specified in 10. Outline Drawing
2-3 旋转方向 Rotation	C.W/C.C.W (clockwise or counter clockwise)	
2-4 马达位置 Motor position	全方位 All position	
2-5 使用电压范围 Operating voltage	2.2~3.6V DC	
2-6 使用环境 Operating environment	-30 ~ 70℃, 常湿 /Ordinary Humidity:65±20%RH	无水气凝结 No condensation of moisture
2-7 保存环境 Storage environment	-40 ~ 80℃, 常湿 /Ordinary Humidity:65±20%RH	无水气凝结 No condensation of moisture

3. 测定条件/Measuring Conditions

项目/Item	规格/Specifications	条件·备注/ Conditions & Remarks
3-1 温度 Temperature	20±2℃	
3-2 湿度 Humidity	63%~67% RH	
3-3 位置 Motor position	轴向水平 Motor shaft horizontal	将马达固定在试验台上 Lock the motor in a test fixture

标准测试条件为温度 20℃，湿度 65%。如无疑异，也可在温度 5~35℃、湿度 45~85%的条件下测试。马达测试时，放置方向为轴向水平。/The measurement at 20℃ & 65%RH is standard. If the judgment is not questionable, recognize measurement at 5℃ to 35℃ & relative humidity 45% to 85%. Direction of motor is shaft horizontal.

4. 机械要求/Mechanical Specifications

项目/Item	规格/ Specifications	条件·备注/ Conditions & Remarks
4-1 结构 Configuration	见 10. 外形图 As specified in 10. Outline Drawing	Outline drawing No: Z4TH5B1241992
4-2 外观 Appearance	不含有机机械损坏及不适当的浸蚀等。 There shall be no evidence of mechanical damage and shall not have inadequate corrosion and so on	目测（容许范围根据样品外形） Visual examination(allowable extent is based on boundary sample)
4-3 轴向间隙 Shaft end play	0.05mm~0.2mm	
4-4 振子固定力 Holding strength of vibration weight	30N (3kgf) Min	

6. 可靠性/Reliability

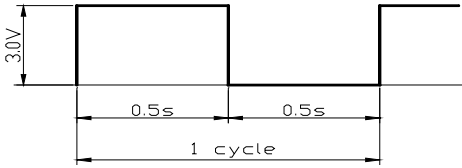
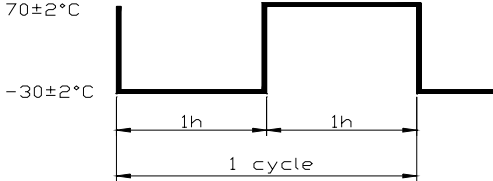
项目/Item	规格/ Specifications	判定标准/Judgment												
6-1 寿命 Life time	 <table border="1" data-bbox="363 497 1008 676"> <thead> <tr> <th>位置 Position</th> <th>电压 Volt</th> <th>负荷 Load</th> <th>温度 Temp</th> <th>湿度 Humi</th> <th>寿命 Life</th> </tr> </thead> <tbody> <tr> <td>轴水平 Horizon</td> <td>Rated 额定</td> <td>Weight 振子</td> <td>20°C</td> <td>65%</td> <td>200,000 Cycles</td> </tr> </tbody> </table>	位置 Position	电压 Volt	负荷 Load	温度 Temp	湿度 Humi	寿命 Life	轴水平 Horizon	Rated 额定	Weight 振子	20°C	65%	200,000 Cycles	<p>试验后, 马达应符合项 7-1 的要求。 After the test, motors shall be approved as specified in item 7-1.</p>
位置 Position	电压 Volt	负荷 Load	温度 Temp	湿度 Humi	寿命 Life									
轴水平 Horizon	Rated 额定	Weight 振子	20°C	65%	200,000 Cycles									
6-2 低温放置 Low temp exposure	温度 /Temperature: $-40\pm 2^{\circ}\text{C}$ 时间 /Time: 96h	<p>在常温常湿下放置 2h 后, 马达应符合项 7-2 的要求。 After 2 hours exposure in ordinary temperature and humidity, Motors shall be approved as specified in item 7-2.</p>												
6-3 高温放置 High temp. Exposure	温度 /Temperature: $80\pm 2^{\circ}\text{C}$ 时间 /Time: 96h													
6-4 湿度放置 Humidity exposure	温度 /Temperature: $40\pm 2^{\circ}\text{C}$ 湿度 /Humidity: $90\sim 95\%\text{RH}$ 放置时间 /Exposure time: 96h 无水气凝结/No condensation of moisture													
6-5 振动 Vibration	频率 /Frequency: $10\sim 55\sim 10\text{Hz}$ 全振幅 /Displacement: 1.5mm (p-p) 加速度 /Acceleration: 22m/s^2 周期 /Period: 20min 完成 $10\sim 55\sim 10\text{Hz}$ /20 Minutes log sweep $10\sim 55\sim 10\text{Hz}$ 方向 /Direction: x, y, z 时间 /Time: 每个方向 2h /Each 2 hours													
6-6 自然跌落 Free fall	试验状态/Test state: 将马达固定在约 100 克 (包括马达本身) 的物体上, 落向水泥地面。 Set the motor to the approximately 100g (include the motor) weight of block drop the motor on the concrete floor. 高度 /Height: 1.5m 方向 /Direction: 6 个面 / 6 faces 次数 /Number of times: 每个面 2 次 / Twice 2 each	<p>测试结果应符合项 7-2 的要求。 After the test motors shall be approved as specified in item 7-2.</p>												
6-7 热冲击 Heat shock test	试验循环 /Test cycle :20 cycles 	<p>在常温常湿下放置 2h 后, 马达应符合项 7-2 的要求。 After 2 hours exposure in ordinary temperature and humidity, Motors shall be approved as specified in item 7-2.</p>												

(Z4TH5) 圆柱马达包装
Packaging drawing of Z4TH5 cylindrical motor

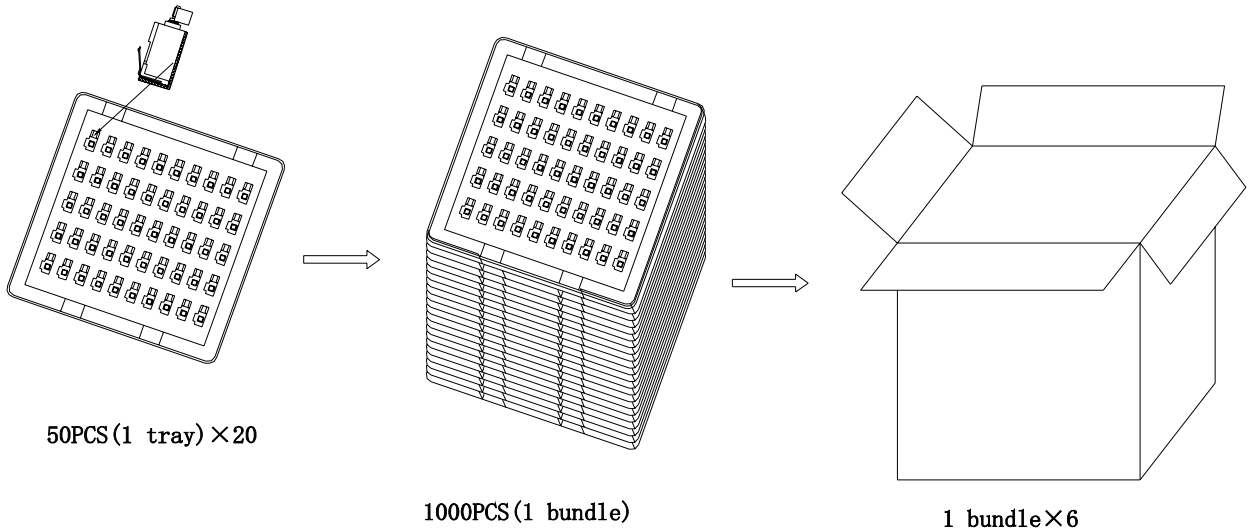

包装试验要求

1. 标准

- (1) 整箱重量小于等于9kg的, 跌落高度设定为75cm.
- (2) 整箱重量大于9kg但小于等于23kg的, 跌落高度设定为60cm.

2. 试验方法:

跌落要求为六面三棱一角.

- (1) 六面: 先从最大两面跌, 然后是中间大小的两面, 最后跌最小的两面, 一共六次.
- (2) 三棱: 指任选三条同一角的棱, 跌落秩序: 最长棱, 中间长度, 最短的, 一共三次.
- (3) 一角: 指上一步三条棱所组成的角, 跌落一次.

3. 判定基准

经过跌落试验后, 产品外观、性能无不良.

Package Test Requirement:

1. Criteria

- (1) The weight of the whole carton less than 9kg, the dropping height is 75cm.
- (2) The weight of the whole carton more than 9kg and less than 23kg, the dropping height is 60cm.

2. Test Methods:

Dropping requirement is 6 faces, 3 aris, 1 angle.

- (1) 6 faces: First dropping with two biggest faces, then dropping with another two middle faces, at last dropping with two smallest faces, once per face, total 6 faces.
- (2) 3 aris: Choose any 3 aris which make up of the same the angle, the dropping sequence is the longest aris, middle aris, shortest aris. Total 3 times.
- (3) 1 angle: Point to the angle which is made up with the 3 aris in the above step. Dropping for 1 time.

3. Judgement Criterion

After drop test, no evidence of damage on the appearance and performance.

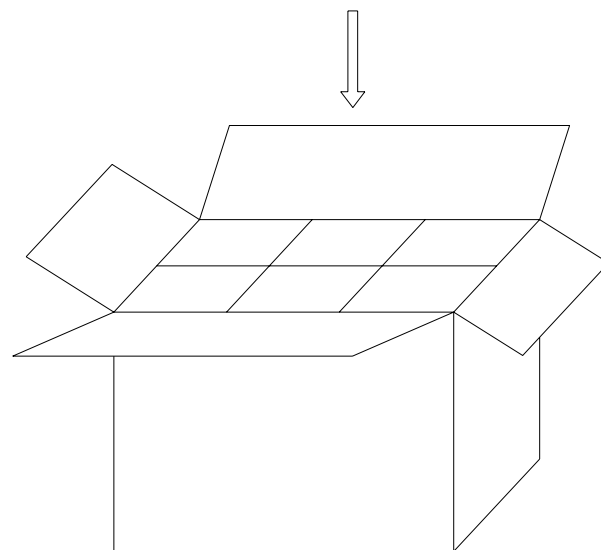

Remarks:

6000PCS/CTN: 52cm × 35cm × 24.5cm

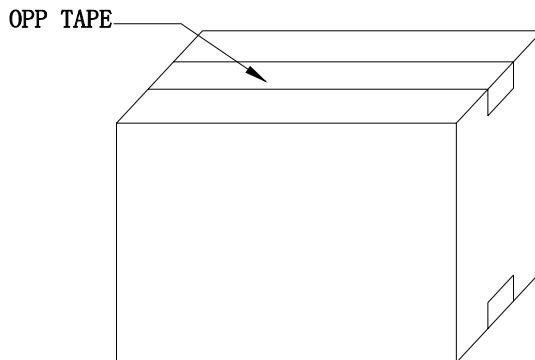

10. 外形图/Outline Drawing

www.jinlong-machinery.com

Z4TH5B1241992

PCB Land drawing
(working)

技术要求/Technical requirement

- 1.额定电压/Rated voltage:3.0V
- 2.额定电流/Rated current:65mA Max
- 3.额定转速/Rated speed:13500 ± 2500rpm
- 4.堵转电流/Stall current:85mA Max
- 5.端子阻抗/Terminal resistance:45Ω (± 20%)
- 6.起动电压/Starting voltage:2.0V Max
- 7.轴向间隙/Shaft end play:0.05~0.2mm
- 8.所有尺寸为A向压紧后的尺寸(不包括轴向间隙)
/Overall length is measured after counterweight being pressed against body in direction A. (Shaft end play is not included.)
- 9.未注线性公差为/Unmarked tolerance: ± 0.1mm

借(通)用件登记									
底图总号									
签字									
日期									

标记	处数	分区	更改文件号	签名	日期
设计	郭梦秋	2009.09.16	标准化		
校对	汪丰华	2009.09.16			
审核	郑景海	2009.09.16			
工艺	刘林兵	2009.09.16	批准	项瑞坚	2009.09.16

jinlong-machinery.com		
阶段标记	重量	比例
		5:1
共 页	第 页	

金龙机电股份有限公司

外形图

Z4TH5B1241992

2009.09.16

说明书/Specification

编号/NO. KOTL-B-799

代码/code: 0

8/9

