

## Chopper-Stabilized Precision Vertical Hall-Effect Latch

### FEATURES AND BENEFITS

- AEC-Q100 automotive qualified
- Magnetic sensing parallel to surface of the package
- Highly sensitive switch thresholds
- Symmetrical latch switch points
- Operation from unregulated supply down to 3 V
- Small package sizes
- Automotive grade
  - Output short-circuit protection
  - Resistant to physical stress
  - Reverse-battery protection
  - Solid-state reliability
  - Superior temperature stability
  - Supply voltage Zener clamp

### PACKAGES:

**3-Pin SOT23-W  
(Suffix LH)**

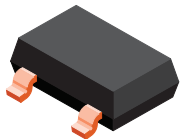

**3-Pin SIP  
(Suffix UA)**

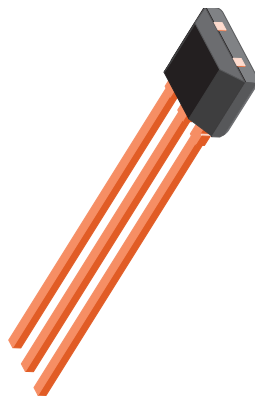

*Not to scale*

### DESCRIPTION

The A1260 vertical Hall-effect sensor IC is an extremely temperature-stable and stress-resistant magnetic-sensing device ideal for harsh operating environments. The sensor is actuated by alternating north and south polarity magnetic fields in plane with the device's branded face. Two package options, the SOT23W surface-mount and SIP through-hole, allow sensing in a variety of orientations with respect to the mounting position. Superior high-temperature performance is made possible through dynamic offset cancellation, which reduces the residual offset voltage normally caused by device overmolding, temperature dependencies, and thermal stress.

Each device includes on a single silicon chip a voltage regulator, a Hall-voltage generator, a small-signal amplifier, chopper stabilization, a Schmitt trigger, and a short-circuit protected NMOS output to sink up to 25 mA. The on-board regulator permits operation with supply voltages of 3 to 24 V. The advantage of operating down to 3 V is that the device can be used in 3.3 V applications, while allowing additional external resistance in series with the supply pin for greater protection against high-voltage transient events.

The output is turned on when a south pole of sufficient strength perpendicular to the vertical Hall element is present. A north pole is necessary to turn the output off. Package type LH is a modified SOT23W surface-mount package that switches with magnetic fields oriented perpendicularly to the non-ledged side of the package. The UA package is an ultra-mini SIP, equipped

*Continued on next page...*

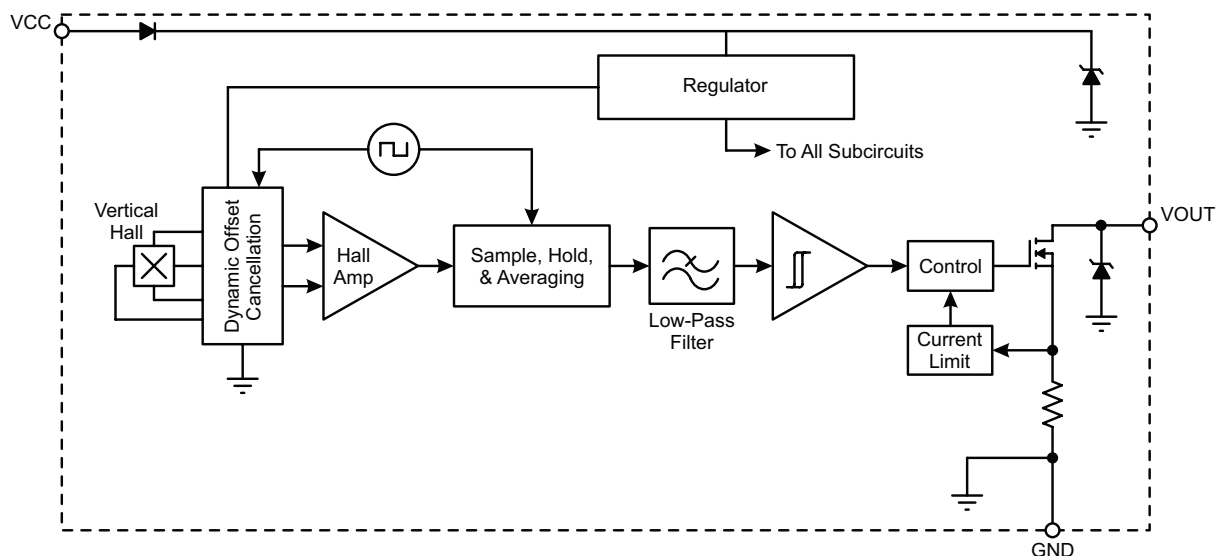

**Functional Block Diagram**

## DESCRIPTION (continued)

for through-hole mounting and lead forming, that switches when a magnetic field is presented to the top of the package, parallel with the branded face. Both packages are RoHS-compliant and lead (Pb) free (suffix, -T), with 100% matte-tin-plated leadframes.

## SPECIFICATIONS

### Selection Guide

Part Number	Packing	Package	Ambient, T <sub>A</sub> (°C)
A1260ELHLT-T	7-in. reel, 3000 pieces/reel	3-pin surface mount SOT23W	-40 to 85
A1260ELHLX-T	13-in. reel, 10000 pieces/reel	3-pin surface mount SOT23W	-40 to 85
A1260LLHLT-T	7-in. reel, 3000 pieces/reel	3-pin surface mount SOT23W	-40 to 150
A1260LLHLX-T	13-in. reel, 10000 pieces/reel	3-pin surface mount SOT23W	-40 to 150
A1260EUA-T <sup>1</sup>	500 pieces per bulk bag	SIP-3 through hole	-40 to 85
A1260LUA-T <sup>1</sup>	500 pieces per bulk bag	SIP-3 through hole	-40 to 150



<sup>1</sup> Please contact Allegro for availability.

### Absolute Maximum Ratings

Characteristic	Symbol	Notes	Rating	Unit
Forward Supply Voltage	V <sub>CC</sub>		26.5	V
Reverse Supply Voltage	V <sub>RCC</sub>		-18	V
Output off voltage	V <sub>OUT</sub>		26	V
Continuous Output Current	I <sub>OUT</sub>		25	mA
Reverse Output Current	I <sub>OUTR</sub>		-50	mA
Operating Ambient Temperature	T <sub>A</sub>	Range E	-40 to 85	°C
		Range L	-40 to 150	°C
Maximum Junction Temperature	T <sub>J(MAX)</sub>		165	°C
Storage Temperature	T <sub>S</sub>		-65 to 170	°C

### Pin-Out Diagrams and Terminal List Table

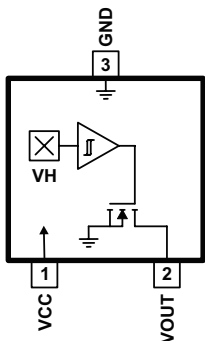

Package LH Pin-Out

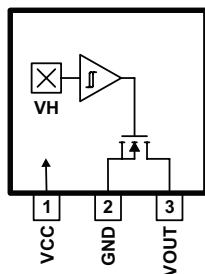

Package UA Pin-Out

### Terminal List Table

Symbol	Pin Number		Description
	LH Package	UA Package	
VCC	1	1	Power Supply to Chip
VOUT	2	3	Output from Circuit
GND	3	2	Ground

### ELECTRICAL CHARACTERISTICS: valid over full operating voltage and temperature ranges (unless otherwise specified)

Characteristics	Symbol	Test Conditions	Min.	Typ. <sup>1</sup>	Max.	Unit <sup>2</sup>
Supply Voltage	$V_{CC}$	Operating, $T_J < 165^\circ\text{C}$	3	–	24	V
Output Leakage Current	$I_{OUTOFF}$	$V_{OUT} = 24\text{ V}$ , $B < B_{RP}$	–	–	10	$\mu\text{A}$
Output Saturation Voltage	$V_{OUT(SAT)}$	$I_{OUT} = 20\text{ mA}$ , $B > B_{OP}$	–	230	500	mV
Output Current Limit	$I_{OM}$	$B > B_{OP}$	30	–	60	mA
Power-On Time <sup>3</sup>	$t_{PO}$	$V_{CC} > 3.0\text{ V}$ , $B < B_{RP(MIN)} - 10\text{ G}$ , $B > B_{OP(MAX)} + 10\text{ G}$	–	–	25	$\mu\text{s}$
Chopping Frequency	$f_C$		–	800	–	kHz
Output Rise Time <sup>3,4</sup>	$t_r$	$R_L = 820\ \Omega$ , $C_S = 20\text{ pF}$	–	0.2	2	$\mu\text{s}$
Output Fall Time <sup>3,4</sup>	$t_f$	$R_L = 820\ \Omega$ , $C_S = 20\text{ pF}$	–	0.1	2	$\mu\text{s}$
Supply Current	$I_{CC}$		–	2.5	4	mA
Reverse Battery Current	$I_{RCC}$	$V_{RCC} = -18\text{ V}$	–	–	–5	mA
Supply Zener Clamp Voltage	$V_Z$	$I_{CC} = 5\text{ mA}$ ; $T_A = 25^\circ\text{C}$	28	34	–	V
Zener Impedance	$I_Z$	$I_{CC} = 5\text{ mA}$ ; $T_A = 25^\circ\text{C}$	–	50	–	$\Omega$

### MAGNETIC CHARACTERISTICS: valid over full operating voltage and temperature ranges (unless otherwise specified)

Characteristics	Symbol	Test Conditions	Min.	Typ.	Max.	Unit <sup>2</sup>
Operate Point	$B_{OP}$		5	25	50	G
Release Point	$B_{RP}$		–50	–25	–5	G
Hysteresis	$B_{HYS}$	$B_{OP} - B_{RP}$	20	50	80	G

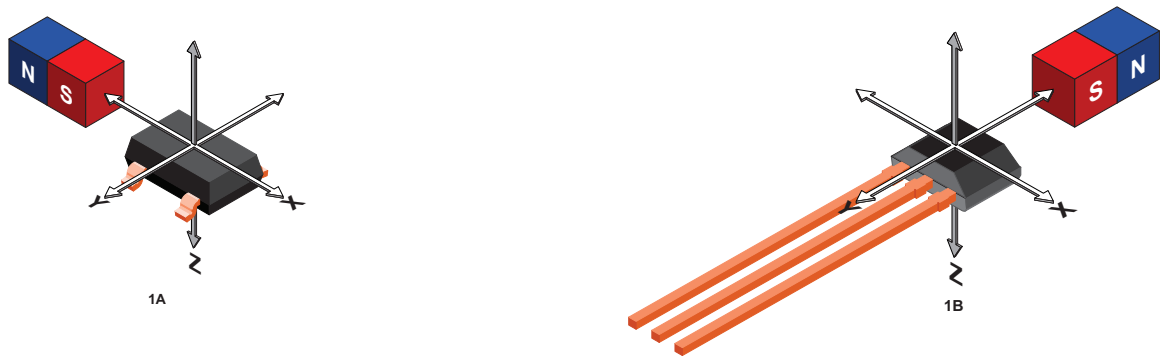

Figure 1: Magnet Orientation for Switching Output On for LH package (Panel 1A) and UA Package (Panel 1B)

<sup>1</sup> Typical data is at  $T_A = 25^\circ\text{C}$  and  $V_{CC} = 12\text{ V}$  and it is for design information only

<sup>2</sup> 1 G (gauss) = 0.1 mT (millitesla).

<sup>3</sup> Power on time, Rise time and Fall time are guaranteed through device characterization

<sup>4</sup>  $C_S$  = oscilloscope probe capacitance.

Thermal Characteristics: may require derating at maximum conditions; see application information

Characteristic	Symbol	Notes	Rating	Unit
Package Thermal Resistance	$R_{\theta JA}$	Package LH, 2-layer PCB with 0.463 in. <sup>2</sup> of copper area each side connected by thermal vias	110	°C/W
		Package LH, 1-layer PCB with copper limited to solder pads	228	°C/W
		Package UA, 1-layer PCB with copper limited to solder pads	165	°C/W

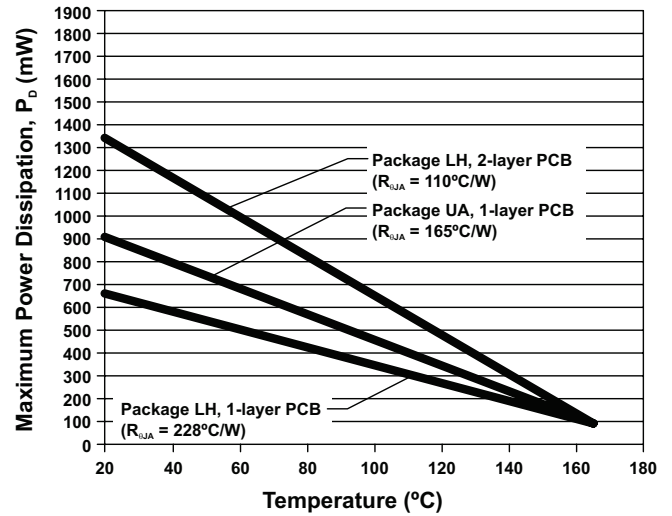
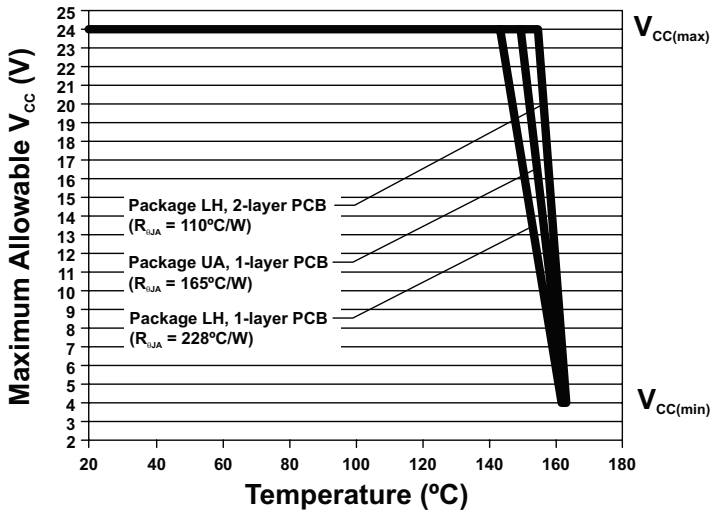

## ELECTRICAL OPERATING CHARACTERISTICS

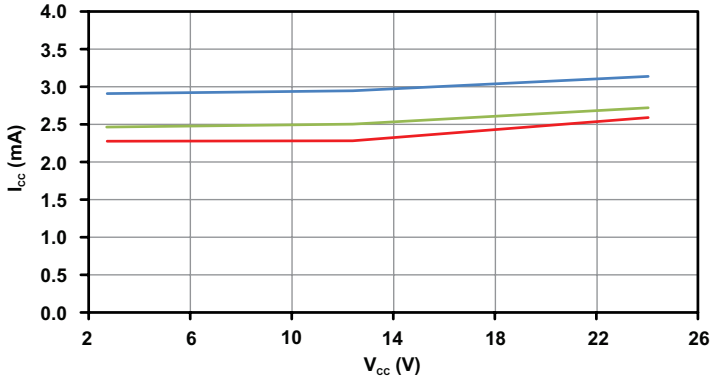

Average Supply Current versus Supply Voltage

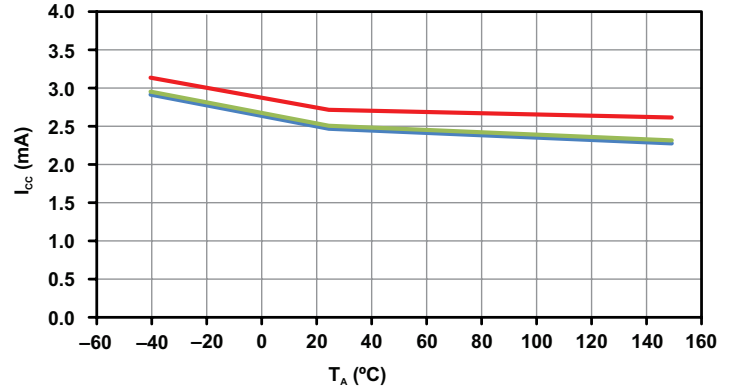

Average Supply Current versus Ambient Temperature

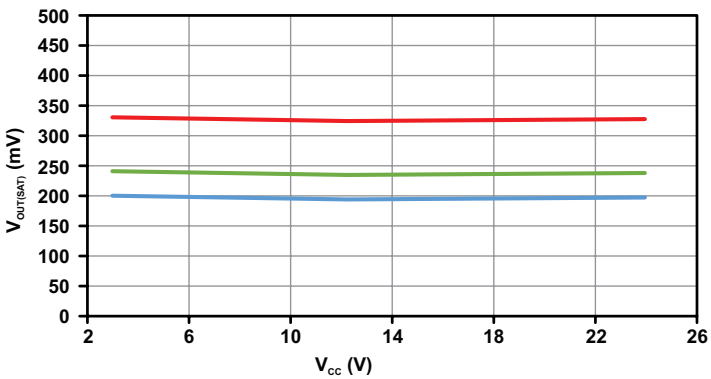

Average Low Output Voltage versus Supply Voltage

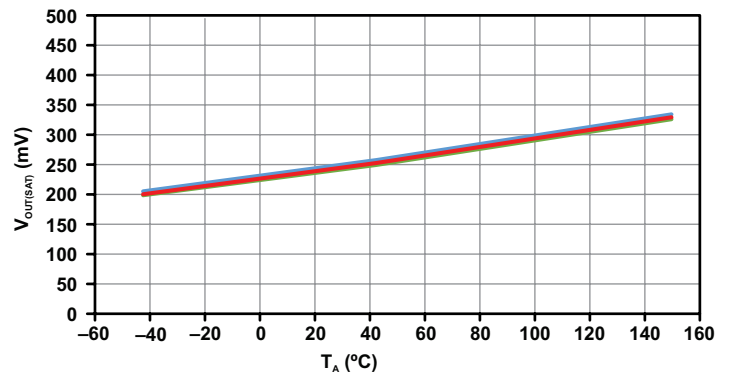

Average Low Output Voltage versus Ambient Temperature for I<sub>OUT</sub> = 20 mA

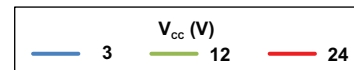
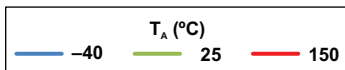

## MAGNETIC OPERATING CHARACTERISTICS

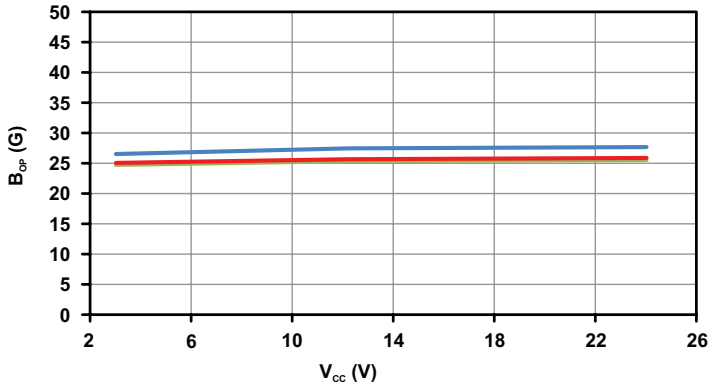

Average Operate Point versus Supply Voltage

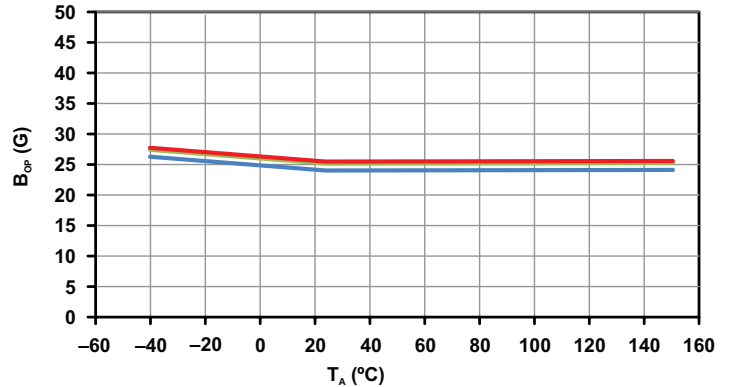

Average Operate Point versus Ambient Temperature

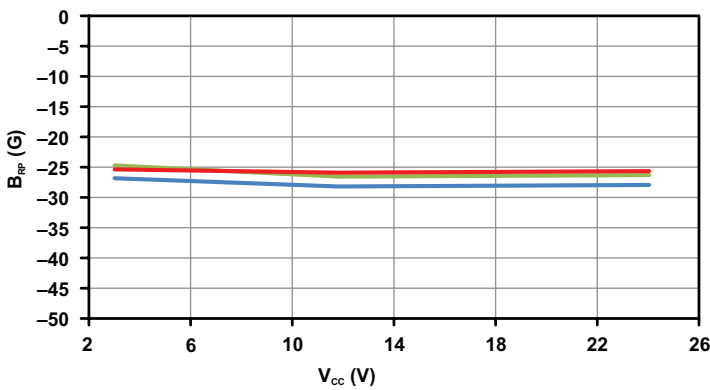

Average Release Point versus Supply Voltage

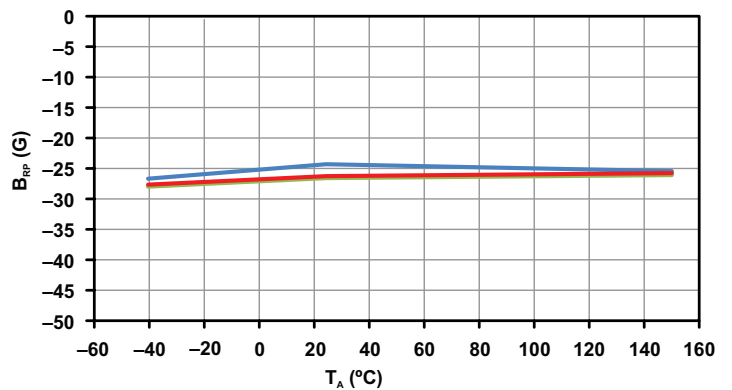

Average Release Point versus Ambient Temperature

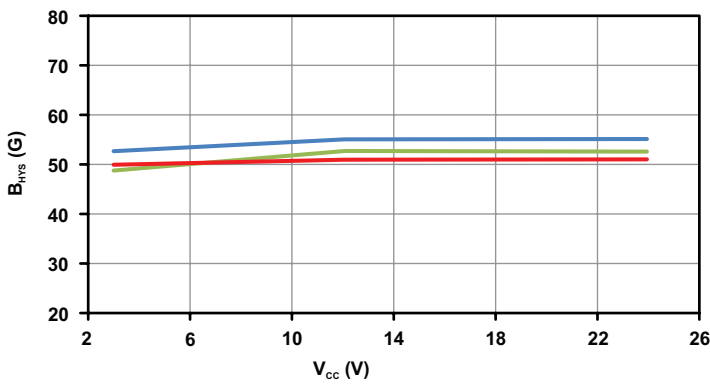

Average Switchpoint Hysteresis versus Supply Voltage

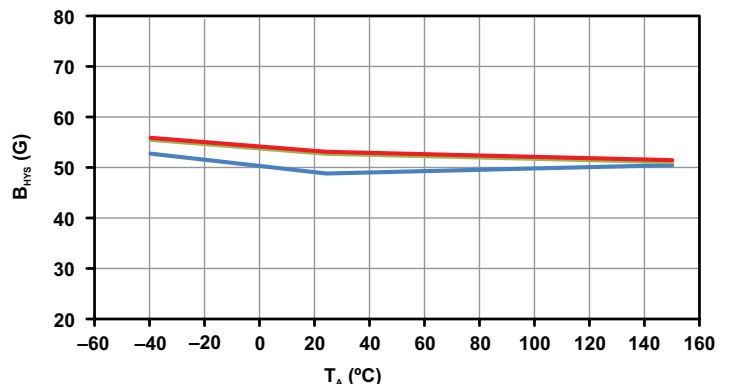

Average Switchpoint Hysteresis versus Ambient Temperature

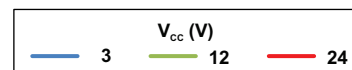
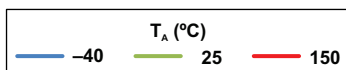

FUNCTIONAL DESCRIPTION

Operation

The output of these devices switches low (turns on) when a south polarity magnetic field perpendicular to the Hall-effect sensor exceeds the operate point threshold ( $B_{OP}$ ). The LH package is offered with a vertical Hall element capable of sensing magnetic fields perpendicular to the non-leaded side of the package closest to pin 1. The UA package vertical Hall element senses fields perpendicular to the top of the package opposite of the device leads.

The magnetic field is perpendicular to the Hall-effect sensor when the direction of the field is parallel to the X-axis for the LH package (see panel 2A in Figure 2) and Y-axis for the UA package (see panel 2B in Figure 2). After turn-on, the output voltage is  $V_{OUT(SAT)}$ . The output transistor is capable of sinking current up to the short circuit current limit  $I_{OM}$ , which is a minimum of 30 mA. The device output goes high (turns off) when the magnetic field is reduced below the release point ( $B_{RP}$ ), which requires a north pole of sufficient strength.

Removal of the magnetic field will leave the device output latched on if the last crossed switch point is  $B_{OP}$ , or latched off if the last crossed switch point is  $B_{RP}$ .

The difference in the magnetic operate and release points is the hysteresis ( $B_{HYS}$ ) of the device. This built-in hysteresis allows clean switching of the output even in the presence of external mechanical vibration and electrical noise.

Powering-on the device in the hysteresis range (less than  $B_{OP}$  and higher than  $B_{RP}$ ) will give an indeterminate output state. A valid state is attained after the first excursion beyond  $B_{OP}$  or  $B_{RP}$ .

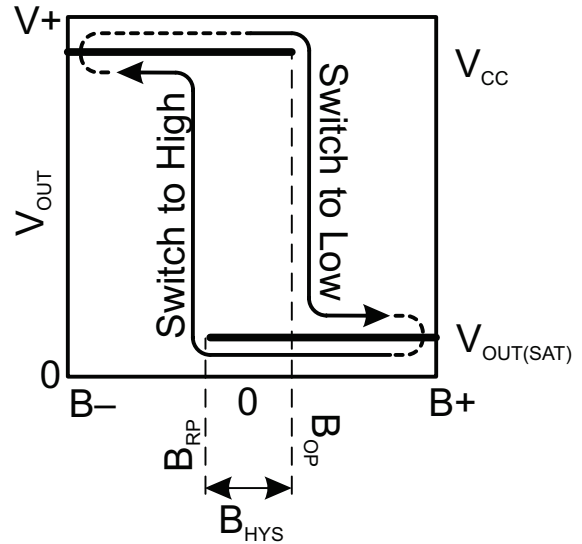

Figure 3: Switching Behavior of Latches

On the horizontal axis, the B+ direction indicates increasing south polarity magnetic field strength, and the B- direction indicates increasing north polarity magnetic field strength. Removal of the magnetic field will leave the device latched in its current state.

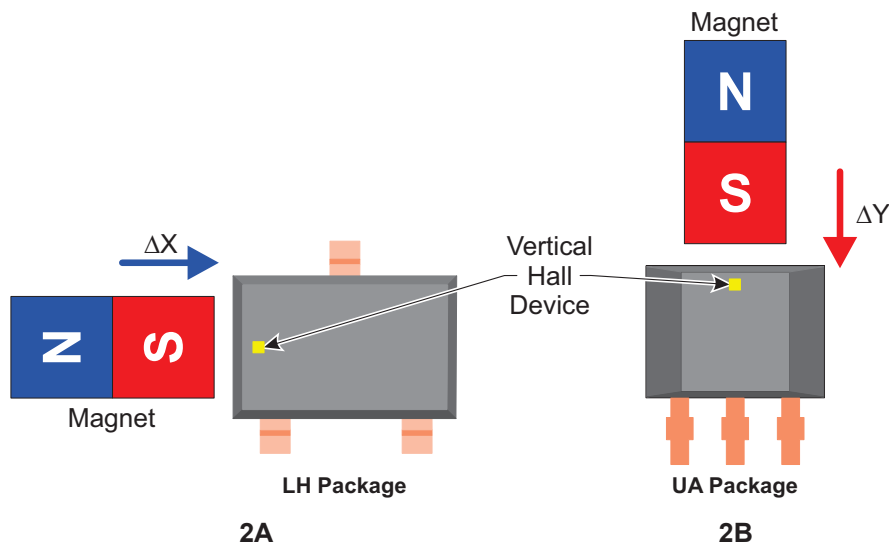

Figure 2: Vertical Hall Sensing

(Left) LH package orientation and (Right) UA package orientation (Not to scale)

### APPLICATIONS

It is strongly recommended that an external capacitor be connected (in close proximity to the Hall-effect sensor IC) between the supply and ground of the device to reduce both external noise and noise generated by the chopper stabilization technique. As shown in Figure 4, a 0.1  $\mu\text{F}$  capacitor is typical.

Extensive applications information on magnets and Hall-effect sensors is available in:

- *Hall-Effect IC Applications Guide, AN27701,*
- *Hall-Effect Devices: Guidelines For Designing Subassemblies Using Hall-Effect Devices AN27703.1*
- *Soldering Methods for Allegro's Products – SMT and Through-Hole, AN26009*

All are provided on the Allegro Web site:

[www.allegromicro.com](http://www.allegromicro.com)

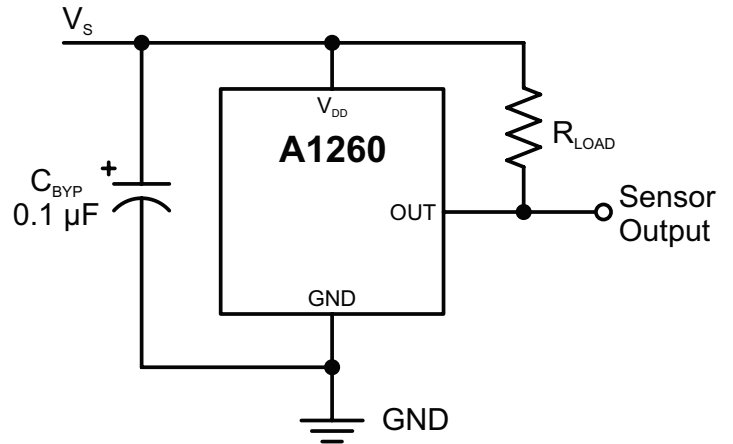

Figure 4: Typical Application Circuit



## CHOPPER STABILIZATION

A limiting factor for switchpoint accuracy when using Hall-effect technology is the small-signal voltage developed across the Hall plate. This voltage is proportionally small relative to the offset that can be produced at the output of the Hall sensor. This makes it difficult to process the signal and maintain an accurate, reliable output over the specified temperature and voltage range. Chopper stabilization is a proven approach used to minimize Hall offset.

The Allegro technique, dynamic quadrature offset cancellation, removes key sources of the output drift induced by temperature and package stress. This offset reduction technique is based on a signal modulation-demodulation process. Figure 5: Model of Chopper Stabilization Circuit (Dynamic Offset Cancellation) illustrates how it is implemented.

The undesired offset signal is separated from the magnetically induced signal in the frequency domain through modulation. The subsequent demodulation acts as a modulation process for

the offset causing the magnetically induced signal to recover its original spectrum at baseband while the dc offset becomes a high-frequency signal. Then, using a low-pass filter, the signal passes while the modulated DC offset is suppressed. Allegro's innovative chopper stabilization technique uses a high-frequency clock. The high-frequency operation allows a greater sampling rate that produces higher accuracy, reduced jitter, and faster signal processing. Additionally, filtering is more effective and results in a lower noise analog signal at the sensor output. Devices such as the A1260 that utilize this approach have an extremely stable quiescent Hall output voltage, are immune to thermal stress, and have precise recoverability after temperature cycling. This technique is made possible through the use of a BiCMOS process which allows the use of low offset and low noise amplifiers in combination with high-density logic and sample-and-hold circuits.

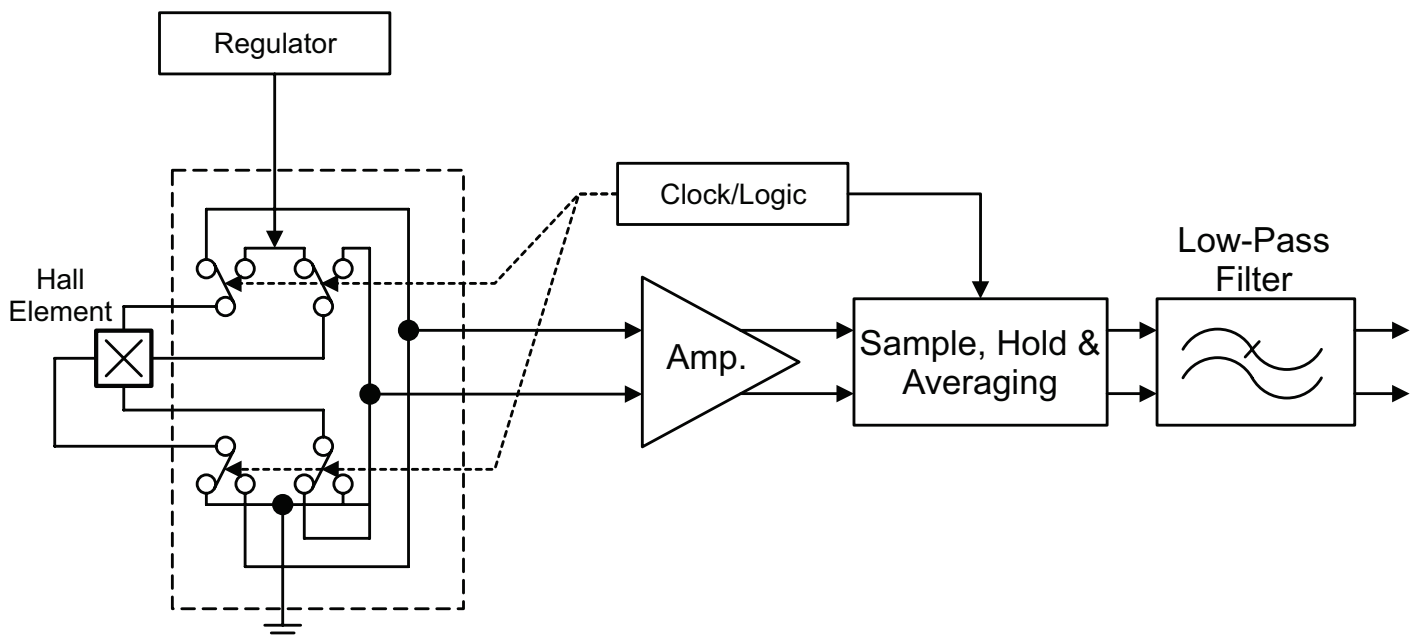

Figure 5: Model of Chopper Stabilization Circuit (Dynamic Offset Cancellation)

## POWER DERATING

The device must be operated below the maximum junction temperature of the device ( $T_{J(max)}$ ). Under certain combinations of peak conditions, reliable operation may require derating supplied power or improving the heat dissipation properties of the application. This section presents a procedure for correlating factors affecting operating  $T_J$ . (Thermal data is also available on the Allegro MicroSystems Web site.)

The Package Thermal Resistance ( $R_{\theta JA}$ ) is a figure of merit summarizing the ability of the application and the device to dissipate heat from the junction (die), through all paths to the ambient air. Its primary component is the Effective Thermal Conductivity (K) of the printed circuit board, including adjacent devices and traces. Radiation from the die through the device case ( $R_{\theta JC}$ ) is relatively small component of  $R_{\theta JA}$ . Ambient air temperature ( $T_A$ ) and air motion are significant external factors, damped by overmolding.

The effect of varying power levels (Power Dissipation,  $P_D$ ), can be estimated. The following formulas represent the fundamental relationships used to estimate  $T_J$ , at  $P_D$ .

$$P_D = V_{IN} \times I_{IN} \quad (1)$$

$$\Delta T = P_D \times R_{\theta JA} \quad (2)$$

$$T_J = T_A + \Delta T \quad (3)$$

For example, given common conditions such as:

$T_A = 25^\circ\text{C}$ ,  $V_{CC} = 12\text{ V}$ ,  $I_{CC} = 2.5\text{ mA}$ , and  $R_{\theta JA} = 110^\circ\text{C/W}$  for the LH package, then:

$$P_D = V_{CC} \times I_{CC} = 12\text{ V} \times 2.5\text{ mA} = 30\text{ mW}$$

$$\Delta T = P_D \times R_{\theta JA} = 30\text{ mW} \times 110^\circ\text{C/W} = 3.3^\circ\text{C}$$

$$T_J = T_A + \Delta T = 25^\circ\text{C} + 3.3^\circ\text{C} = 28.3^\circ\text{C}$$

A worst-case estimate ( $P_{D(max)}$ ) represents the maximum allowable power level ( $V_{CC(max)}$ ,  $I_{CC(max)}$ ), without exceeding  $T_{J(max)}$ , at a selected  $R_{\theta JA}$  and  $T_A$ .

Example: Reliability for  $V_{CC}$  at  $T_A = 150^\circ\text{C}$ , package LH, using low-K PCB.

Observe the worst-case ratings for the device, specifically:

$R_{\theta JA} = 228^\circ\text{C/W}$ ,  $T_{J(max)} = 165^\circ\text{C}$ ,  $V_{CC(max)} = 24\text{ V}$ , and  $I_{CC(max)} = 4\text{ mA}$ .

Calculate the maximum allowable power level,  $P_{D(max)}$ . First, invert equation 3:

$$\Delta T_{max} = T_{J(max)} - T_A = 165^\circ\text{C} - 150^\circ\text{C} = 15^\circ\text{C}$$

This provides the allowable increase to  $T_J$  resulting from internal power dissipation.

Then, invert equation 2:

$$P_{D(max)} = \Delta T_{max} \div R_{\theta JA} = 15^\circ\text{C} \div 228^\circ\text{C/W} = 66\text{ mW}$$

Finally, invert equation 1 with respect to voltage:

$$V_{CC(est)} = P_{D(max)} \div I_{CC(max)} = 66\text{ mW} \div 4\text{ mA} = 16.4\text{ V}$$

The result indicates that, at  $T_A$ , the application and device can dissipate adequate amounts of heat at voltages  $\leq V_{CC(est)}$ .

Compare  $V_{CC(est)}$  to  $V_{CC(max)}$ . If  $V_{CC(est)} \leq V_{CC(max)}$ , then reliable operation between  $V_{CC(est)}$  and  $V_{CC(max)}$  requires enhanced  $R_{\theta JA}$ . If  $V_{CC(est)} \geq V_{CC(max)}$ , then operation between  $V_{CC(est)}$  and  $V_{CC(max)}$  is reliable under these conditions.

In cases where the  $V_{CC(max)}$  level is known, and the system designer would like to determine the maximum allowable ambient temperature ( $T_{A(max)}$ ), the calculations can be reversed.

For example, in a worst case scenario with conditions  $V_{CC(max)} = 24\text{ V}$ ,  $I_{CC(max)} = 4\text{ mA}$ , and  $R_{\theta JA} = 228^\circ\text{C/W}$  using equation 1 the largest possible amount of dissipated power is:

$$P_D = V_{IN} \times I_{IN}$$

$$P_D = 24\text{ V} \times 4\text{ mA} = 96\text{ mW}$$

Then, by rearranging equations 3:

$$T_{A(max)} = T_{J(max)} - \Delta T$$

$$T_{A(max)} = 165^\circ\text{C/W} - (96\text{ mW} \times 228^\circ\text{C/W})$$

$$T_{A(max)} = 165^\circ\text{C/W} - 21.9^\circ\text{C} = 143.1^\circ\text{C}$$

In another example, the regulated supply voltage is equal to 3 V. Therefore,  $V_{CC(max)} = 3\text{ V}$  and  $I_{CC(max)} = 4\text{ mA}$ . By using equation 1 the largest possible amount of dissipated power is:

$$P_D = V_{IN} \times I_{IN}$$

$$P_D = 3\text{ V} \times 4\text{ mA} = 12\text{ mW}$$

Then, by rearranging equation 3:

$$T_{A(max)} = T_{J(max)} - \Delta T$$

$$T_{A(max)} = 165^\circ\text{C/W} - (12\text{ mW} \times 228^\circ\text{C/W})$$

$$T_{A(max)} = 165^\circ\text{C/W} - 2.7^\circ\text{C} = 162.3^\circ\text{C}$$

The operating temperature range of the device ( $T_A$ ) is limited to between  $-40^\circ\text{C}$  and  $150^\circ\text{C}$ , and in the above case there is sufficient power dissipation head room to operate the device throughout this range.

In the above example, we are not exceeding the maximum junction temperature; however, performance beyond the maximum operating ambient temperature of  $150^\circ\text{C}$  is not guaranteed.

**PACKAGE OUTLINE DRAWING**

**For Reference Only – Not for Tooling Use**

(Reference DWG-2840)

Dimensions in millimeters – NOT TO SCALE

Dimensions exclusive of mold flash, gate burrs, and dambar protrusions  
Exact case and lead configuration at supplier discretion within limits shown

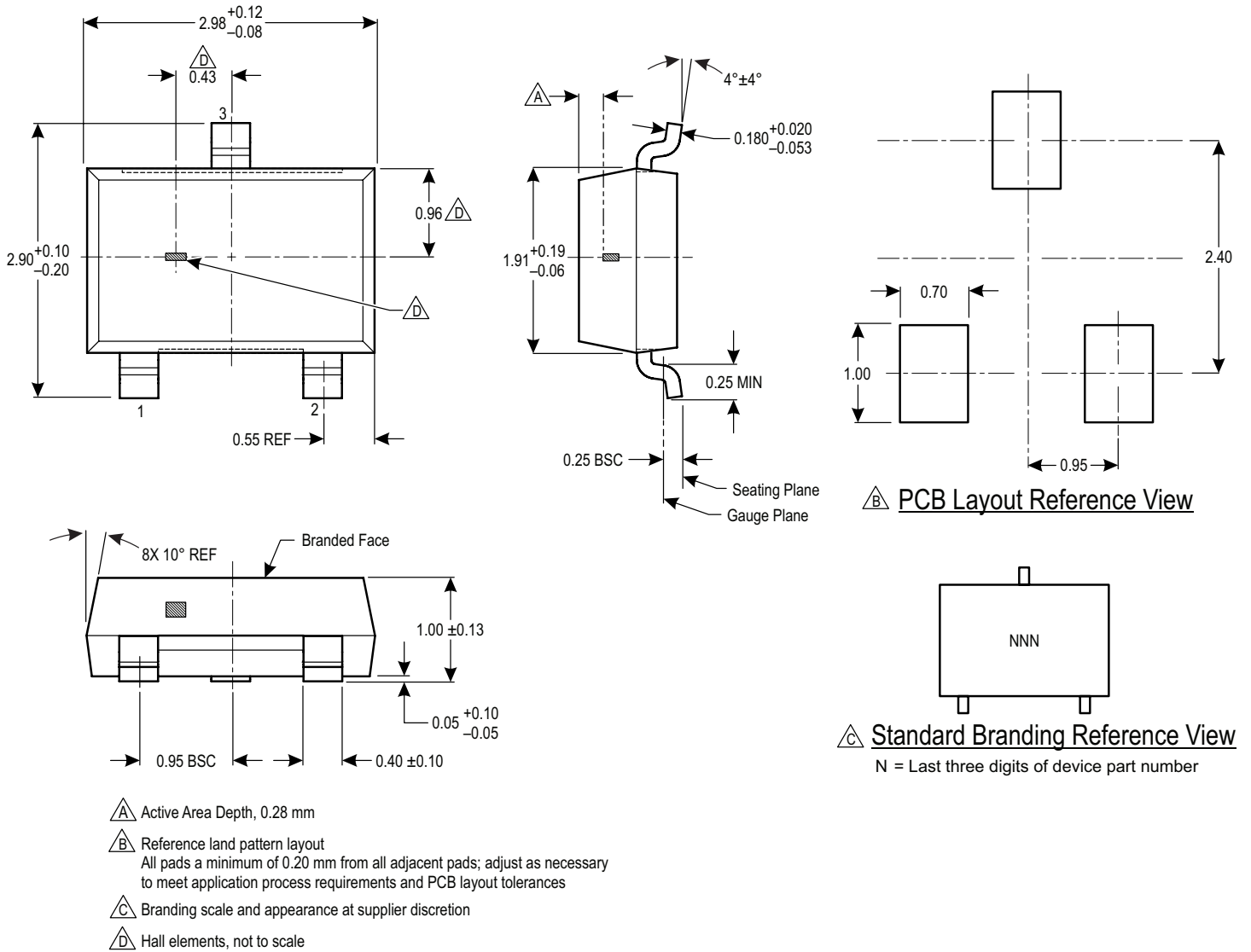

**Figure 6: Package LH, 3-Pin SOT23-W**

**For Reference Only – Not for Tooling Use**

(Reference DWG-9013)  
 Dimensions in millimeters – NOT TO SCALE  
 Dimensions exclusive of mold flash, gate burrs, and dambar protrusions  
 Exact case and lead configuration at supplier discretion within limits shown

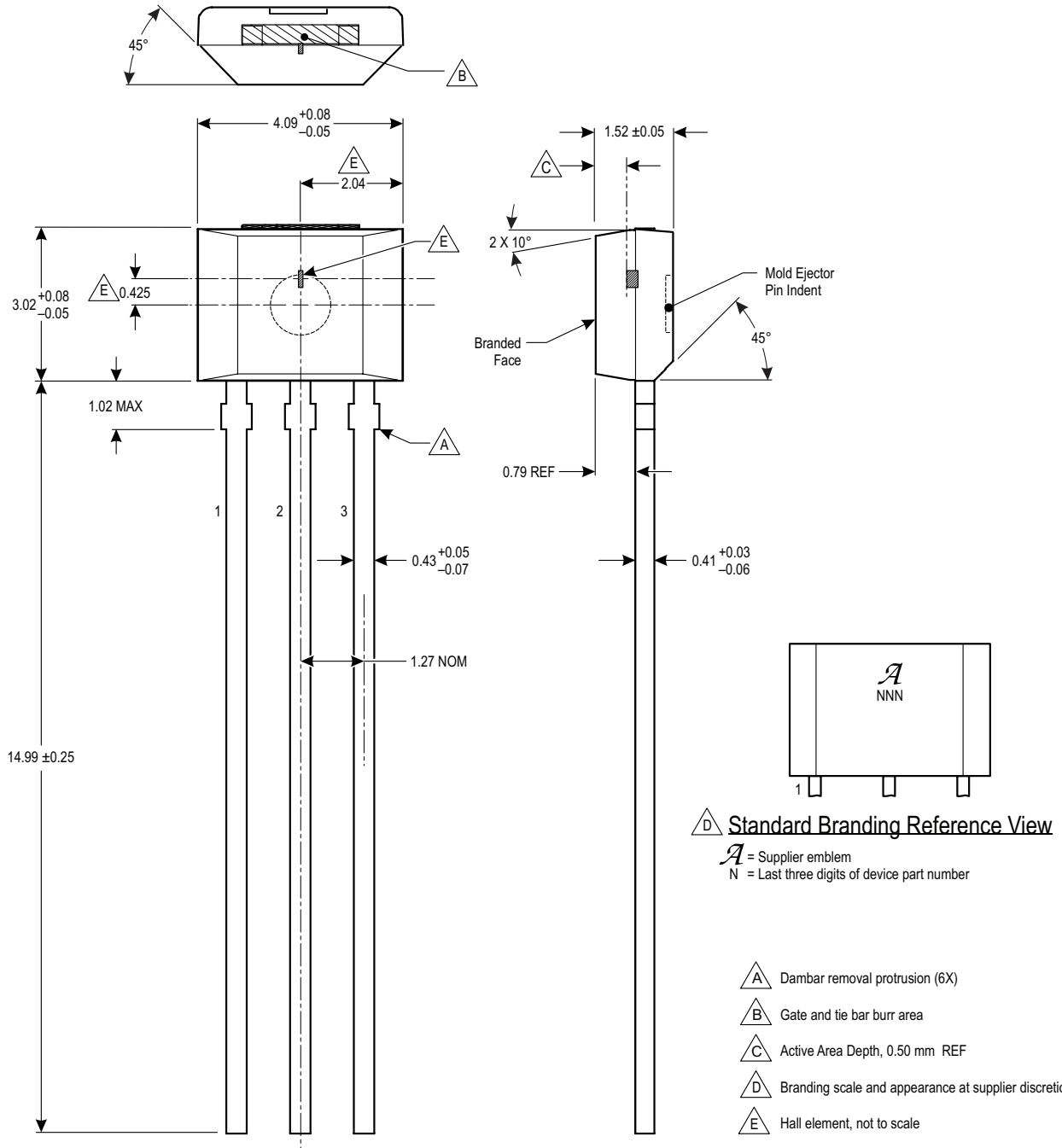

**Figure 7: Package UA, 3-Pin SIP**

**Revision History**

Revision	Revision Date	Description of Revision
–	March 10, 2015	Initial Release
1	July 13, 2015	Corrected LH package Active Area Depth value
2	September 21, 2015	Added AEC-Q100 qualification under Features and Benefits

Copyright ©2016, Allegro MicroSystems, LLC

Allegro MicroSystems, LLC reserves the right to make, from time to time, such departures from the detail specifications as may be required to permit improvements in the performance, reliability, or manufacturability of its products. Before placing an order, the user is cautioned to verify that the information being relied upon is current.

Allegro's products are not to be used in any devices or systems, including but not limited to life support devices or systems, in which a failure of Allegro's product can reasonably be expected to cause bodily harm.

The information included herein is believed to be accurate and reliable. However, Allegro MicroSystems, LLC assumes no responsibility for its use; nor for any infringement of patents or other rights of third parties which may result from its use.

For the latest version of this document, visit our website:

[www.allegromicro.com](http://www.allegromicro.com)

