

BR5005L-G Thru. BR5010L-G

Reverse Voltage: 50 to 1000V

Forward Current: 50A

RoHS Device

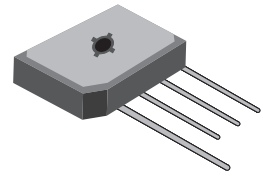

Features

- Plastic case with heatsink for heat dissipation.
- Surge overload -500 Amperes peak.
- UL recognized file # E349301

Mechanical Data

- Epoxy: UL 94V-0 rate flame retardant.
- Case: Molded plastic with heatsink integrally, mounted in the bridge encapsulation.
- Mounting position: Any
- Weight: 30 grams
- Terminals: Wire lead \varnothing 50mils.

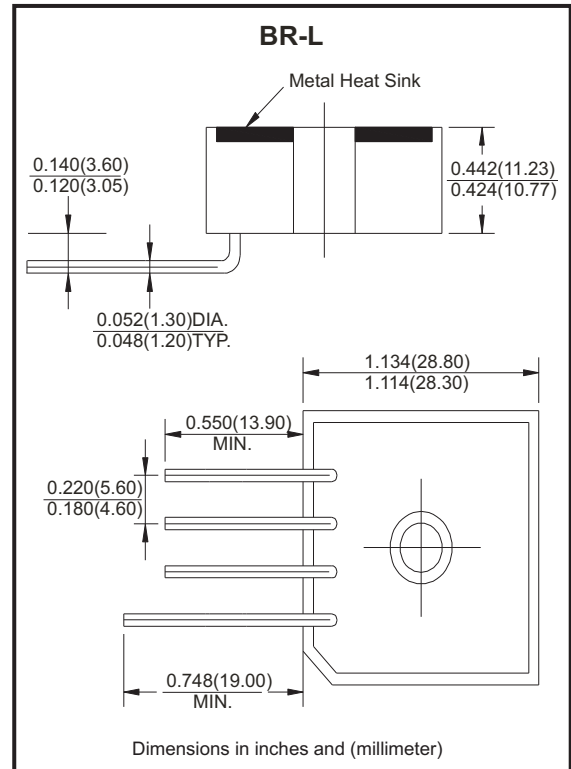

Maximum ratings and electrical characteristics

Rating at 25°C ambient temperature unless otherwise specified.
Single phase, half wave, 60Hz, resistive or inductive load.
For capacitive load, derate current by 20%

Parameter	Symbol	BR 5005L-G	BR 501L-G	BR 502L-G	BR 504L-G	BR 506L-G	BR 508L-G	BR 5010L-G	Unit
Maximum Recurrent Peak Reverse Voltage	V_{RRM}	50	100	200	400	600	800	1000	V
Maximum RMS Bridge Input Voltage	V_{RMS}	35	70	140	280	420	560	700	V
Maximum DC Blocking Voltage	V_{DC}	50	100	200	400	600	800	1000	V
Maximum Average Forward Current for Resistive Load @ $T_c=55^\circ\text{C}$	$I_{(AV)}$	50							A
Peak Forward Surge Current, 8.3ms Single Half Sine-Wave Super Imposed On Rated Load	I_{FSM}	500							A
Maximum Forward Voltage Per Bridge Element at 25A Peak	V_F	1.1							V
Maximum Reverse Current at Rate DC Blocking Voltage	@ $T_J=25^\circ\text{C}$	10							μA
	@ $T_J=100^\circ\text{C}$	1000							
Typical Thermal Resistance (Fig.3)	$R_{\theta JC}$	2.0							$^\circ\text{C/W}$
Operating Temperature Range	T_J	-55 to +150							$^\circ\text{C}$
Storage Temperature Range	T_{STG}	-55 to +150							$^\circ\text{C}$

Rating and Characteristics Curves (BR5005L-G Thru. BR5010L-G)

Fig.1 - Derating Curve Output Rectified Current

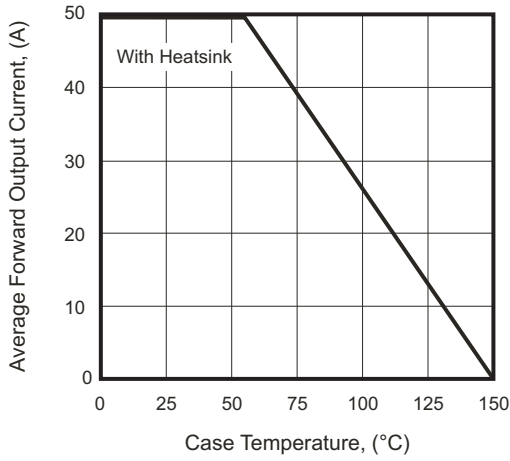

Fig.2 - Maximum Forward Surge Current

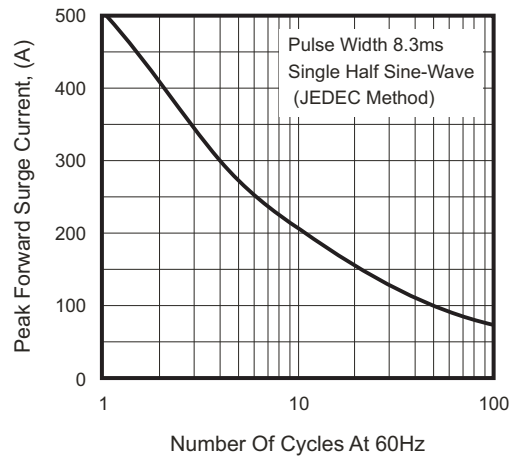

Fig.3 - Typical Forward Characteristics

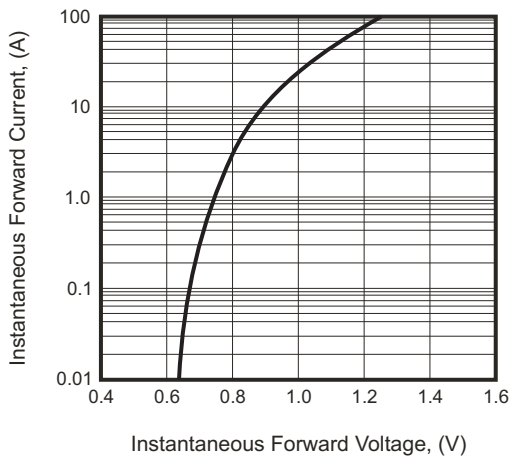
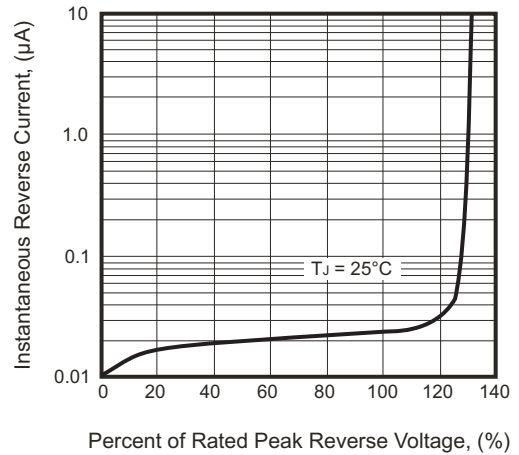
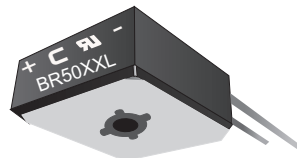

Fig.4 - Typical Reverse Characteristics



Marking Code

Part Number	Marking code
BR5005L-G	BR5005L
BR501L-G	BR501L
BR502L-G	BR502L
BR504L-G	BR504L
BR506L-G	BR506L
BR508L-G	BR508L
BR5010L-G	BR5010L



X / XX = Product type marking code

Standard Packaging

Case Type	BULK PACK	
	BOX (pcs)	CARTON (pcs)
BR-L	60	120