

N-channel MOSFET

Features

- Low gate charge
- 100% avalanche tested
- Improved dv/dt capability
- RoHS compliant
- Halogen free package
- JEDEC Qualification

| | | |
|------------|-------|-----------------|
| BV_{DSS} | I_D | $R_{DS(on)MAX}$ |
| 200V | 18A | <0.17Ω |

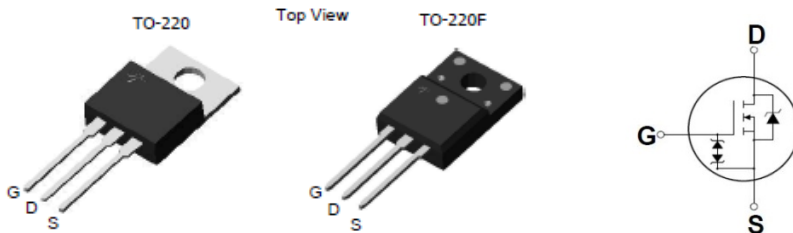

| Device | Package | Marking | Remark |
|-------------------------------|------------------|-------------------------------|--------------|
| GP1M018A020HG/GP1M018A020FG | TO-220 / TO-220F | GP1M018A020HG/GP1M018A020FG | RoHS |
| GP1M018A020HGH/GP1M018A020FGH | TO-220 / TO-220F | GP1M018A020HGH/GP1M018A020FGH | Halogen Free |

Absolute Maximum Ratings

| Parameter | Symbol | GP1M018A020HG | GP1M018A020FG | Unit | |
|---|----------------|-----------------------|---------------|------|------|
| Drain-Source Voltage | V_{DSS} | 200 | | V | |
| Gate-Source Voltage | V_{GS} | ±30 | | V | |
| Continuous Drain Current | I_D | $T_C = 25\text{ °C}$ | 18 | 18 * | A |
| | | $T_C = 100\text{ °C}$ | 9 | 9 * | A |
| Pulsed Drain Current (Note 1) | I_{DM} | 72 | 72 * | A | |
| Single Pulse Avalanche Energy (Note 2) | E_{AS} | 380 | | mJ | |
| Repetitive Avalanche Current (Note 1) | I_{AR} | 18 | | A | |
| Repetitive Avalanche Energy (Note 1) | E_{AR} | 9.4 | | mJ | |
| Power Dissipation | P_D | $T_C = 25\text{ °C}$ | 94 | 30.4 | W |
| | | Derate above 25 °C | 0.75 | 0.24 | W/°C |
| Peak Diode Recovery dv/dt (Note 3) | dv/dt | 4.5 | | V/ns | |
| Operating Junction and Storage Temperature Range | T_J, T_{STG} | -55~150 | | °C | |
| Maximum lead temperature for soldering purposes, 1/8" from case for 5 seconds | T_L | 300 | | °C | |

* Limited only by maximum junction temperature

Thermal Characteristics

| Parameter | Symbol | GP1M018A020HG | GP1M018A020FG | Unit |
|---|-----------------|---------------|---------------|------|
| Maximum Thermal resistance, Junction-to-Case | $R_{\theta JC}$ | 1.33 | 4.1 | °C/W |
| Maximum Thermal resistance, Junction-to-Ambient | $R_{\theta JA}$ | 62.5 | 62.5 | °C/W |

Electrical Characteristics : $T_C=25^\circ\text{C}$, unless otherwise noted

| Parameter | Symbol | Test condition | Min | Typ | Max | Units |
|---|--------------|--|-----|------|------|---------------|
| OFF | | | | | | |
| Drain-Source Breakdown Voltage | BV_{DSS} | $V_{GS} = 0\text{ V}, I_D = 250\ \mu\text{A}$ | 200 | -- | -- | V |
| Zero Gate Voltage Drain Current | I_{DSS} | $V_{DS} = 200\text{ V}, V_{GS} = 0\text{ V}$ | -- | -- | 1 | μA |
| | | $V_{DS} = 160\text{ V}, T_C = 125^\circ\text{C}$ | -- | -- | 10 | μA |
| Forward Gate-Source Leakage Current | I_{GSSF} | $V_{GS} = 30\text{ V}, V_{DS} = 0\text{ V}$ | -- | -- | 100 | μA |
| Reverse Gate-Source Leakage Current | I_{GSSR} | $V_{GS} = -30\text{ V}, V_{DS} = 0\text{ V}$ | -- | -- | -100 | μA |
| ON | | | | | | |
| Gate Threshold Voltage | $V_{GS(th)}$ | $V_{DS} = V_{GS}, I_D = 250\ \mu\text{A}$ | 3 | -- | 5 | V |
| Drain-Source On-Resistance | $R_{DS(on)}$ | $V_{GS} = 10\text{ V}, I_D = 9\text{ A}$ | -- | 0.14 | 0.17 | Ω |
| Forward Transconductance ^(Note 4) | g_{FS} | $V_{DS} = 30\text{ V}, I_D = 9\text{ A}$ | -- | 6 | -- | S |
| DYNAMIC | | | | | | |
| Input Capacitance | C_{iss} | $V_{DS} = 25\text{ V}, V_{GS} = 0\text{ V},$ $f = 1.0\text{ MHz}$ | -- | 950 | -- | pF |
| Output Capacitance | C_{oss} | | -- | 180 | -- | pF |
| Reverse Transfer Capacitance | C_{rss} | | -- | 20 | -- | pF |
| SWITCHING | | | | | | |
| Turn-On Delay Time ^(Note 4,5) | $t_{d(on)}$ | $V_{DD} = 100\text{ V}, I_D = 18\text{ A},$ $R_G = 25\ \Omega$ | -- | 26 | -- | ns |
| Turn-On Rise Time ^(Note 4,5) | t_r | | -- | 30 | -- | ns |
| Turn-Off Delay Time ^(Note 4,5) | $t_{d(off)}$ | | -- | 54 | -- | ns |
| Turn-Off Fall Time ^(Note 4,5) | t_f | | -- | 17 | -- | ns |
| Total Gate Charge ^(Note 4,5) | Q_g | $V_{DS} = 160\text{ V}, I_D = 18\text{ A},$ $V_{GS} = 10\text{ V}$ | -- | 18 | -- | nC |
| Gate-Source Charge ^(Note 4,5) | Q_{gs} | | -- | 4.2 | -- | nC |
| Gate-Drain Charge ^(Note 4,5) | Q_{gd} | | -- | 8.2 | -- | nC |
| SOURCE DRAIN DIODE | | | | | | |
| Maximum Continuous Drain-Source Diode Forward Current | I_S | ---- | -- | -- | 18 | A |
| Maximum Pulsed Drain-Source Diode Forward Current | I_{SM} | ---- | -- | -- | 72 | A |
| Drain-Source Diode Forward Voltage | V_{SD} | $V_{GS} = 0\text{ V}, I_S = 18\text{ A}$ | -- | -- | 1.5 | V |
| Reverse Recovery Time ^(Note 4) | t_{rr} | $V_{GS} = 0\text{ V}, I_S = 18\text{ A}$ $di_F / dt = 100\text{ A}/\mu\text{s}$ | -- | 150 | -- | ns |
| Reverse Recovery Charge ^(Note 4) | Q_{rr} | | -- | 0.7 | -- | μC |

Note :

1. Repeated rating : Pulse width limited by safe operating area
2. $L=1.76\text{mH}, I_{AS} = 18\text{ A}, V_{DD} = 50\text{ V}, R_G = 25\ \Omega,$ Starting $T_J = 25^\circ\text{C}$
3. $I_{SD} \leq 18\text{ A}, di/dt \leq 200\text{ A}/\mu\text{s}, V_{DD} \leq BV_{DS},$ Starting $T_J = 25^\circ\text{C}$
4. Pulse Test : Pulse width $\leq 300\ \mu\text{s},$ Duty Cycle $\leq 2\%$
5. Essentially Independent of Operating Temperature Typical Characteristics

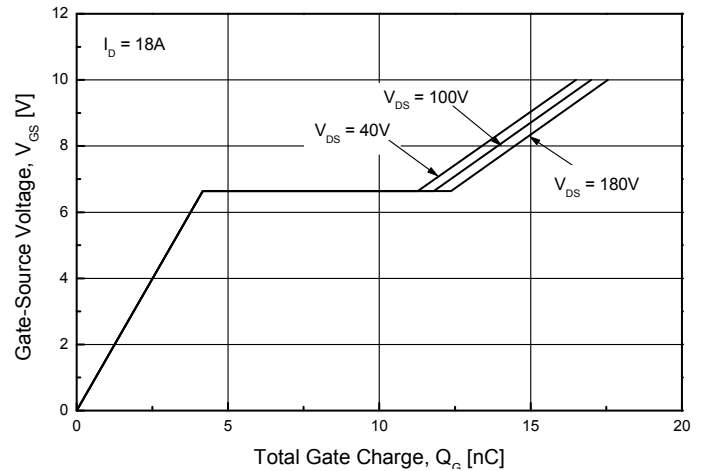
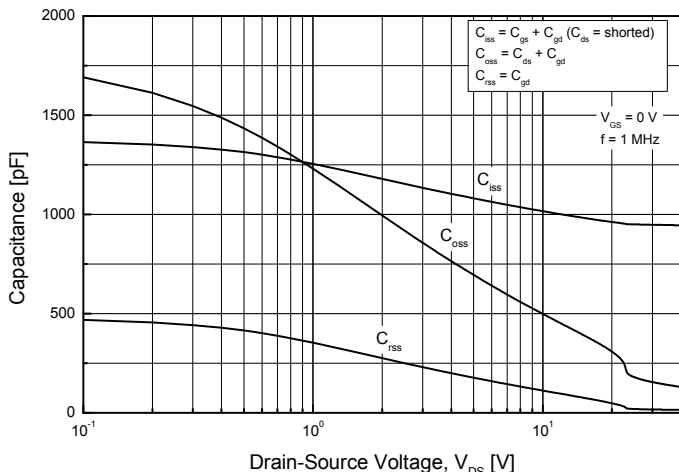
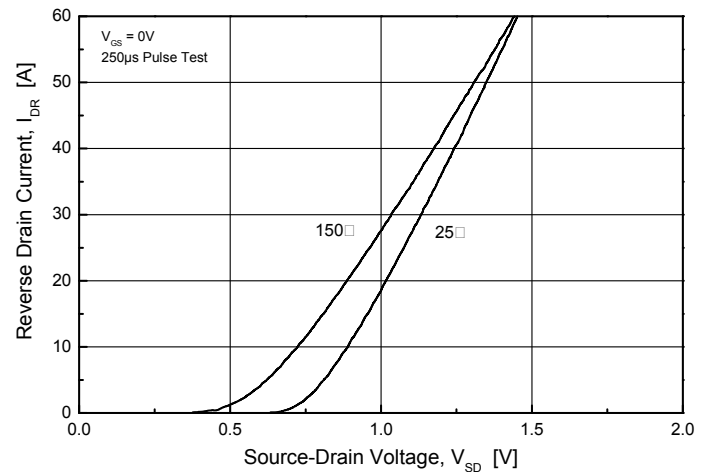
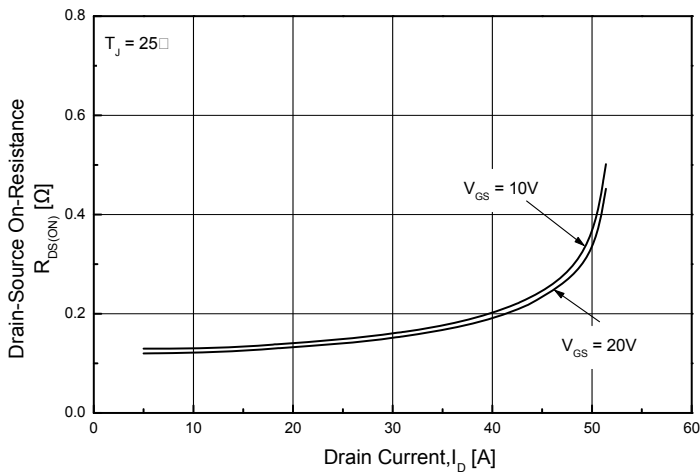
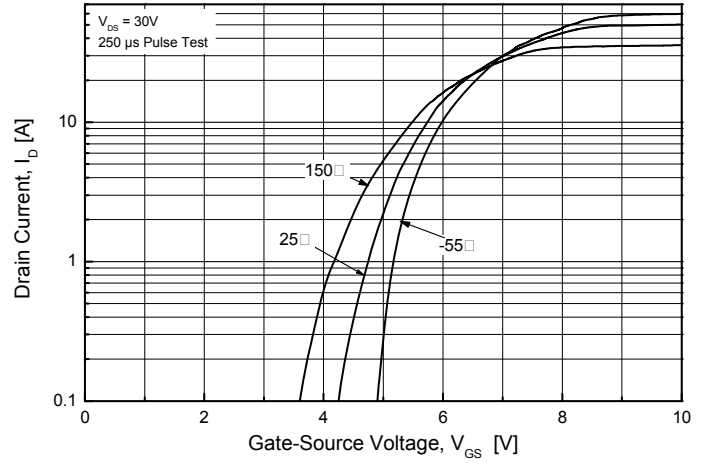
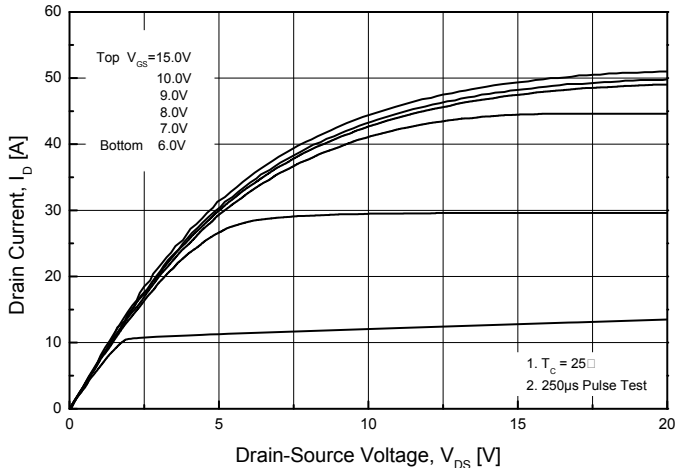

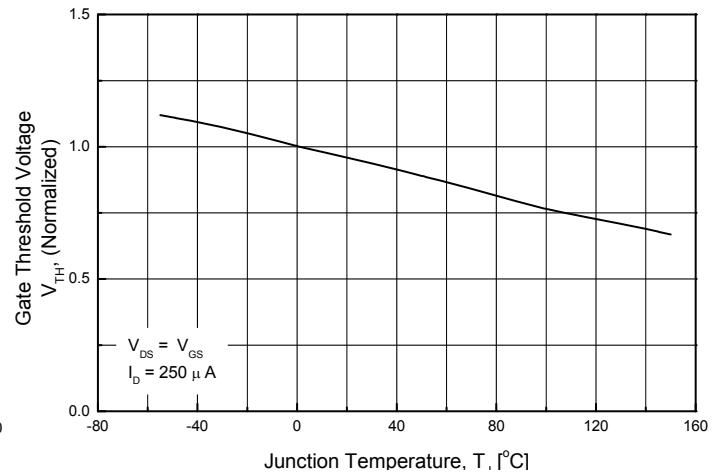
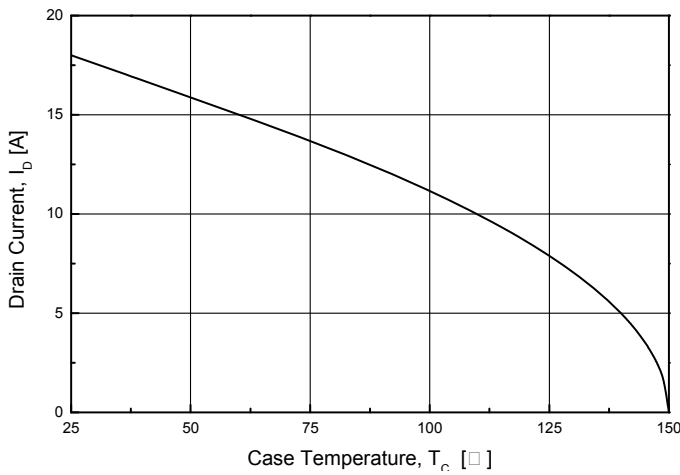
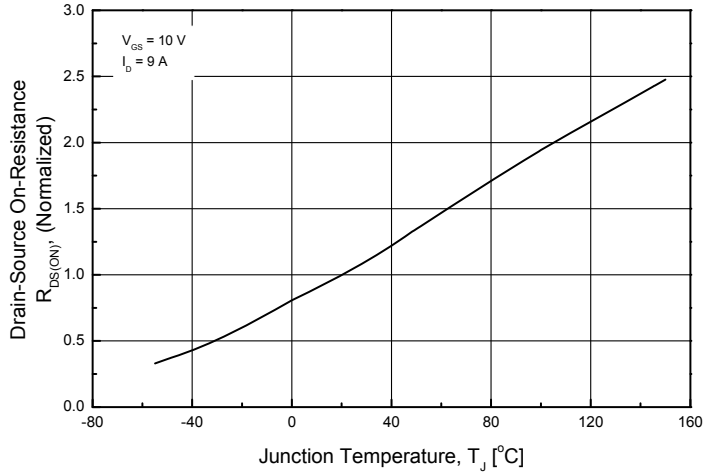
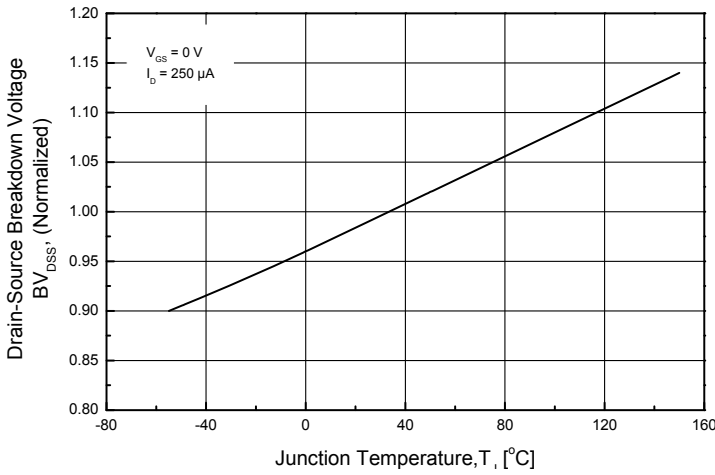

GP1M018A020HG(H)

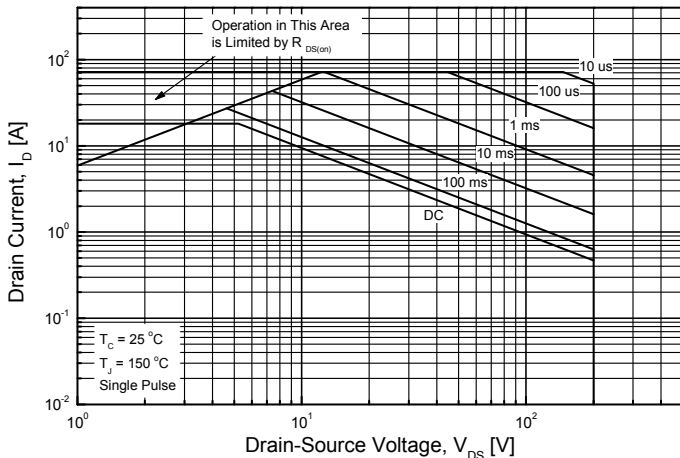

GP1M018A020FG(H)

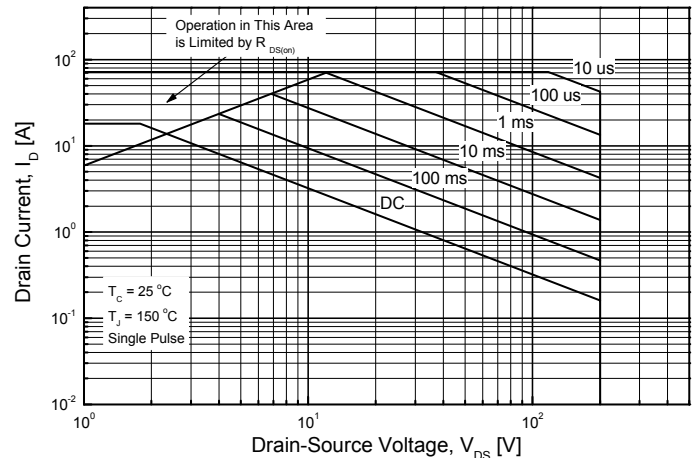

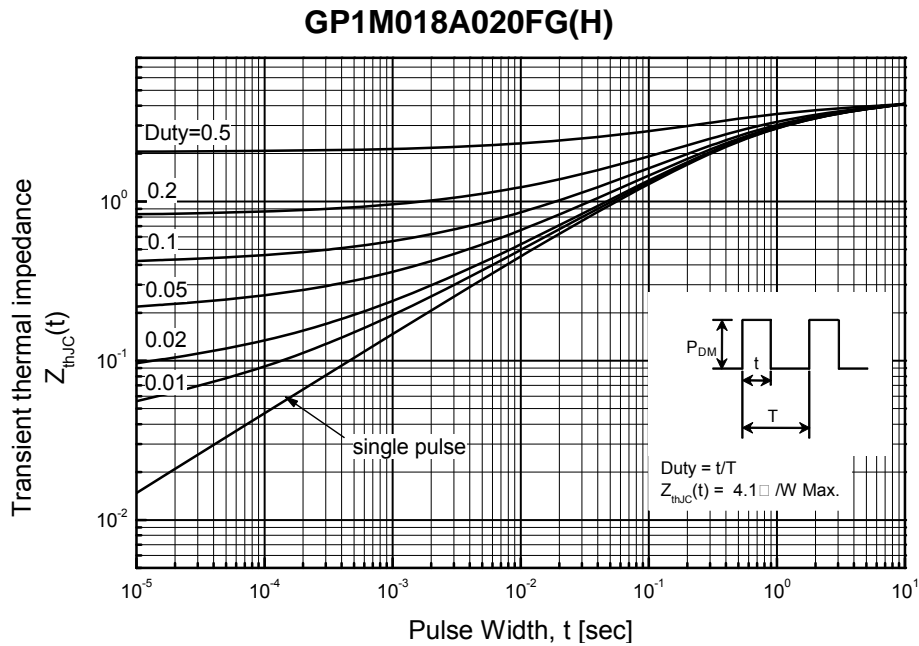
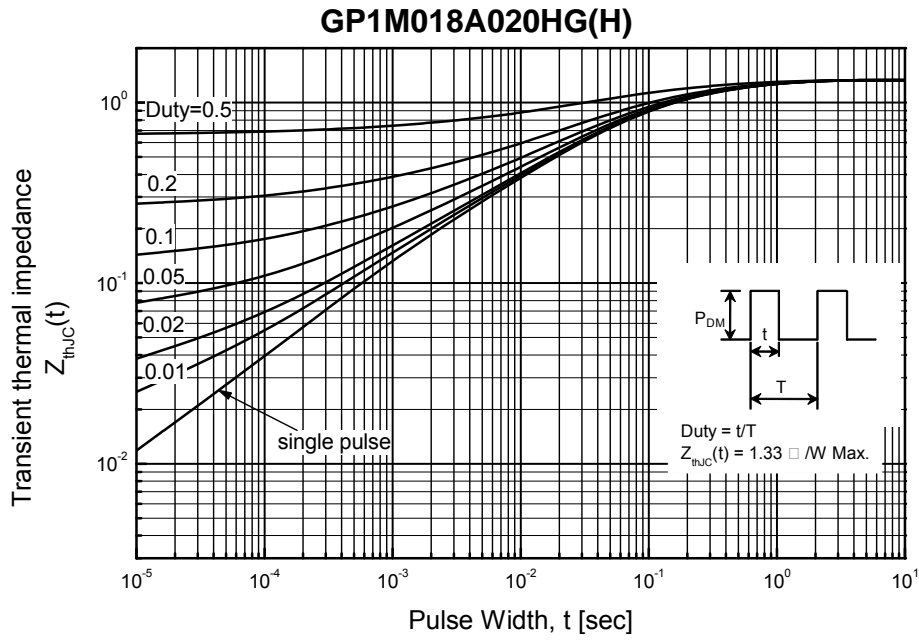

TO-220AB-3L MECHANICAL DATA

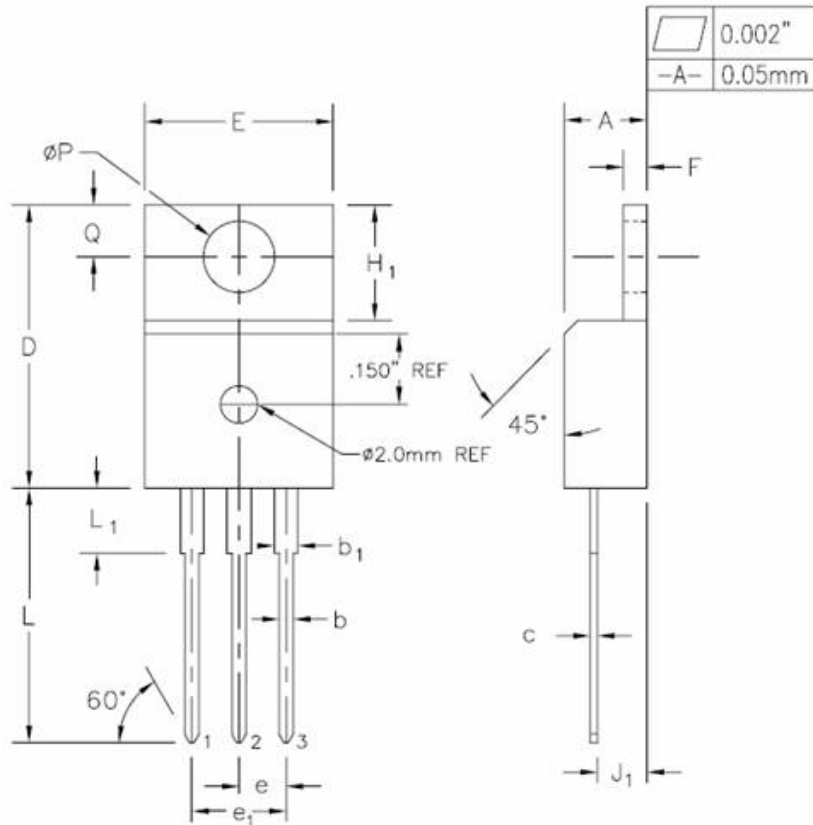

| SYMBOL | INCHES | | MILLIMETERS | | NOTES |
|----------------|------------|-------|-------------|-------|-------|
| | MIN. | MAX. | MIN. | MAX. | |
| A | 0.170 | 0.180 | 4.32 | 4.57 | |
| b | 0.028 | 0.036 | 0.71 | 0.91 | |
| b ₁ | 0.045 | 0.055 | 1.15 | 1.39 | |
| c | 0.014 | 0.021 | 0.36 | 0.53 | |
| D | 0.590 | 0.610 | 14.99 | 15.49 | |
| E | 0.395 | 0.410 | 10.04 | 10.41 | |
| e | 0.100 TYP. | | 2.54 TYP. | | |
| e ₁ | 0.200 BSC | | 5.08 BSC | | |
| F | 0.048 | 0.054 | 1.22 | 1.37 | |
| H ₁ | 0.235 | 0.255 | 5.97 | 6.47 | |
| J ₁ | 0.100 | 0.110 | 2.54 | 2.79 | |
| L | 0.530 | 0.550 | 13.47 | 13.97 | |
| L ₁ | 0.130 | 0.150 | 3.31 | 3.81 | 2 |
| ϕP | 0.149 | 0.153 | 3.79 | 3.88 | |
| Q | 0.102 | 0.112 | 2.60 | 2.84 | |

TO-220F-3L MECHANICAL DATA

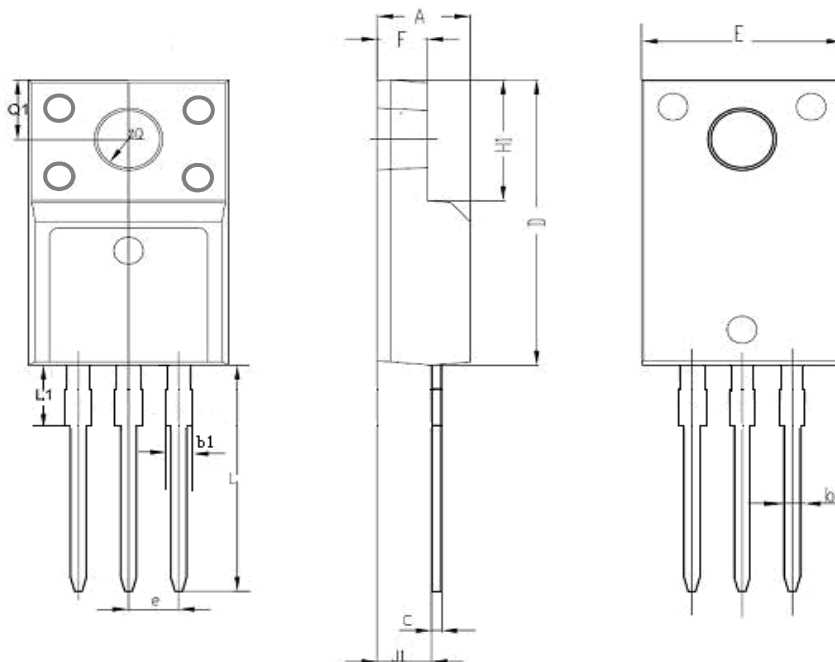

| SYMBOL | INCHES | | MILLIMETERS | | NOTES |
|--------|------------|-------|-------------|-------|-------|
| | MIN | MAX | MIN | MAX | |
| A | 0.178 | 0.194 | 4.53 | 4.93 | |
| b | 0.028 | 0.036 | 0.71 | 0.91 | |
| C | 0.018 | 0.024 | 0.45 | 0.60 | |
| D | 0.617 | 0.633 | 15.67 | 16.07 | |
| E | 0.392 | 0.408 | 9.96 | 10.36 | |
| e | 0.100 TYP. | | 2.54 TYP. | | |
| H1 | 0.256 | 0.272 | 6.50 | 6.90 | |
| J1 | 0.101 | 0.117 | 2.56 | 2.96 | |
| L | 0.503 | 0.519 | 12.78 | 13.18 | |
| φQ | 0.117 | 0.133 | 2.98 | 3.38 | |
| b1 | 0.045 | 0.055 | 1.15 | 1.39 | |
| L1 | 0.114 | 0.130 | 2.9 | 3.3 | |
| Q1 | 0.122 | 0.138 | 3.10 | 3.50 | |
| F | 0.092 | 0.108 | 2.34 | 2.74 | |

Disclaimer :

Global Power Technologies Group reserves the right to make changes without notice to products herein to improve reliability, performance, or design. The information given in this document is believed to be accurate and reliable. However, it shall in no event be regarded as a guarantee of conditions and characteristics. With respect to any information regarding the application of the device, Global Power Technologies Group hereby disclaims any and all warranties and liabilities of any kind, including without limitation, warranties of non-infringement of patent rights of any third party.