

New Scale Technologies

DK-M3-RS-U-1M-20 Developer's Kit Single-Axis

Mirror Positioning System

Miniature piezo smart stage with built-in controller for simple, precise point-to-point positioning

- Piezo stage with familiar digital galvo form factor
- Smallest size: < 12 mm diameter
- Closed-loop controller embedded in stage
 - *No separate electronics needed*
 - 3.3 VDC input
 - Direct digital input of motion commands (I²C, SPI, UART or analog servo)
- Steers beam diameters up to 2 mm
- Angular resolution 0.025 deg (440 μrad) closed loop with built-in absolute position sensor
- Angular resolution 0.0057 deg (100 μrad) open loop with external position sensor provided by user
- Holds position with zero power and no jitter

Mirror positioning on your fingertip

The DK-M3-RS-U-1M-20 is a complete piezoelectric mirror positioning system with a familiar galvo-scanner form factor, but a drastically smaller size: **only 12 mm diameter including the embedded closed-loop controller.**

The mounted aluminum-coated mirror moves at up to 1100 degrees per second with accuracy of 0.25 degrees for precise, point-to-point positioning. The mirror range is +/- 20 degrees.

Embedded controller means tiny size plus fast, easy integration

Patented piezoelectric motors along with position sensors, bearings, drive electronics and embedded firmware are all integrated into the miniature rotary stage.

We've eliminated the extra bulk of a separate external controller.

Along with smallest system size, this makes for fast, easy integration into your system. The positioner accepts direct input of high-level digital motion commands from your system processor, or use the USB adapter for PC control.

Low power for hand-held systems

The mirror positioning system needs only 3.3 V DC and uses approximately 500 mW when moving or 50 mW in standby mode. It can be powered by USB or standard batteries. The integrated piezo motor holds position without using power.

SMALL, PRECISE, SMART ... IN MOTION

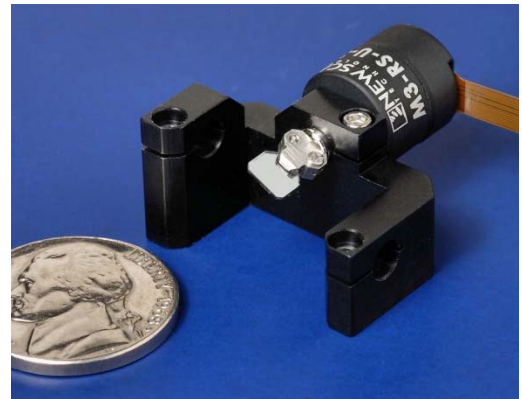

APPLICATIONS

Only 12 mm in diameter, this system is ideal for precise, point-to-point beam steering in a limited space, where dynamic scanning is limited to less than 100 Hz. The 3.3 VDC input makes it suited for handheld and portable instruments.

Medical

- Dermatology lasers, fluorescence microscopes and imaging instruments
- In-vivo and in-vitro micro laser surgery

Industrial

- 3D printers
- LIDAR, 3D measurement, spectroscopy
- Remote sensing (e.g. pollution sources)
- Image and hand tremor stabilization
- Laser marking, engraving, machining

Telecommunications

- Free-space optical communication
- Variable optical attenuation
- Fiber-to-fiber optical switching

Aerospace and Defense

- Target designation, jitter compensation
- Automated obstacle detection, tracking and avoidance for robots, UAVs, etc.

The Developer's Kit

The DK-M3-RS-U-1M-20 Mirror Positioning Developer's Kit includes a smart stage, mounted mirror, base, breakout board, cables, USB adapter and software for system evaluation and development.

Smart Stage with mounted mirror and base

The standard aluminum-coated mirror is pre-mounted on the M3-RS-U smart stage. The stage's built-in controller accepts direct digital and analog servo control via the FPC connector.

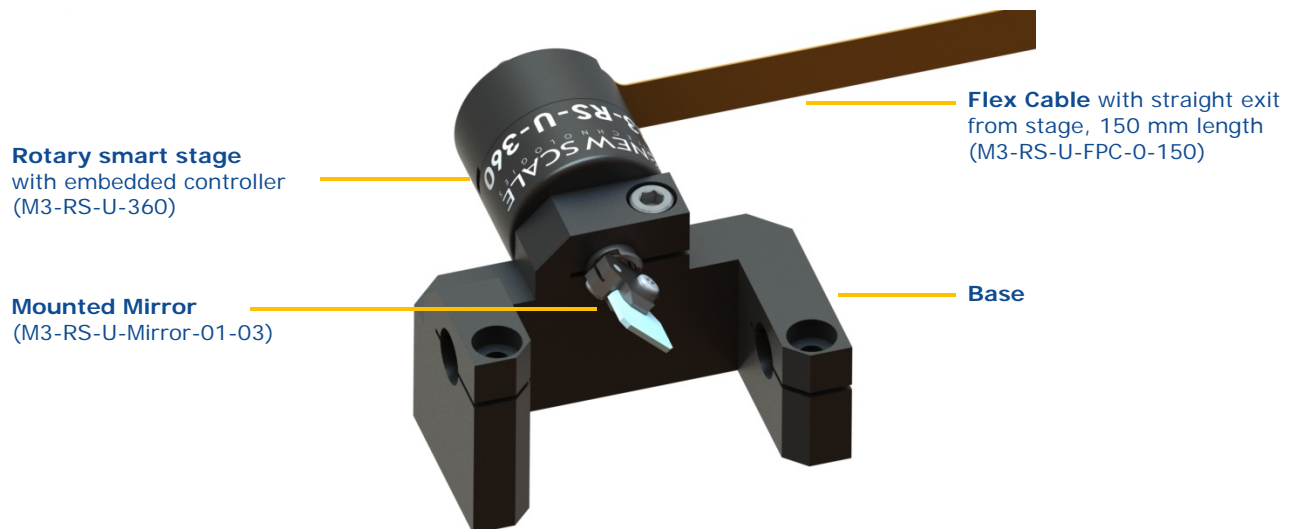

Included accessories

The Developer's Kit accessories include a breakout board, USB adapter, cables, tools and software to aid in evaluation and system development. New Scale Pathway™ software for Windows provides an easy-to-use graphical interface to control multiple stages from one PC screen, or develop your own code using the intuitive scripting tool.

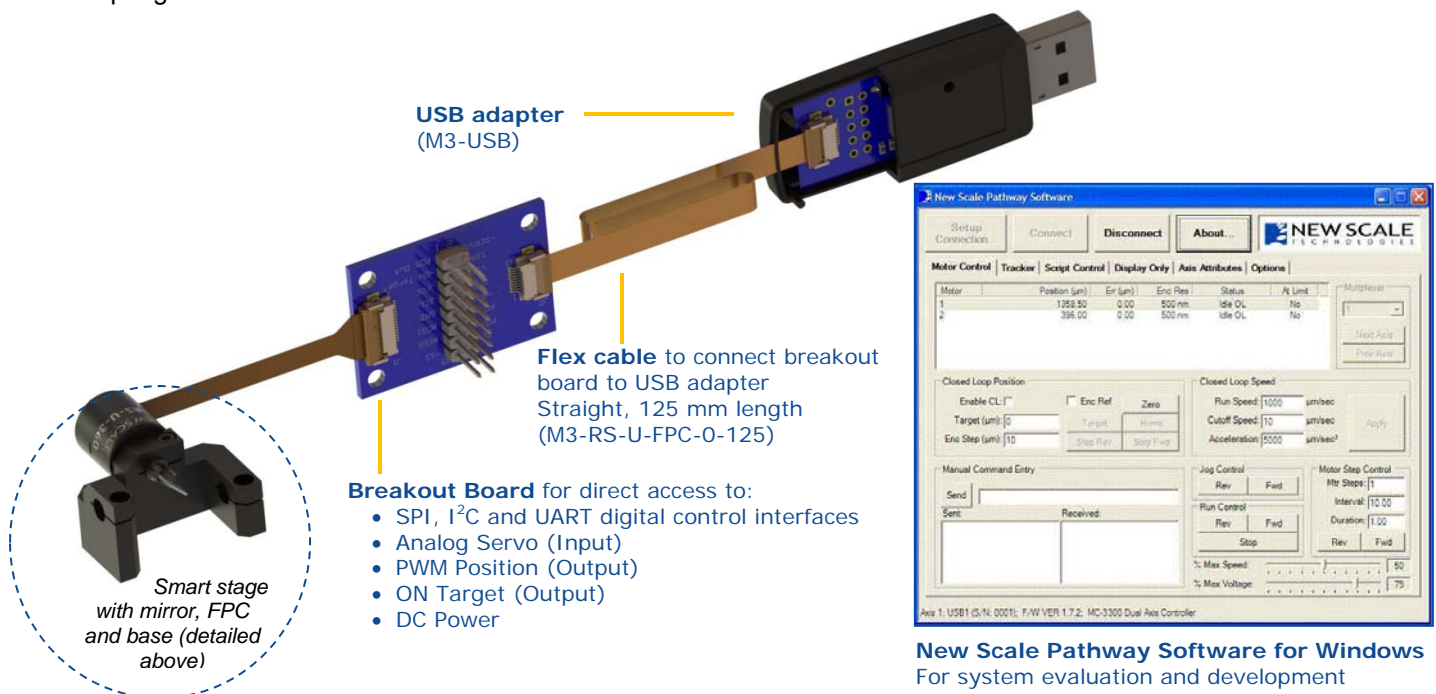

Specifications – DK-M3-RS-U-1M-20 Developer's Kit

M3-RS-U smart stage with standard mounted mirror	
Beam Diameter (maximum)	2 mm
Range of Motion	+/- 20 deg
Speed	>1100 deg/sec
Acceleration	>1,000,000 deg/sec ² *
Stall Torque (minimum)	0.04 N-mm
Holding Torque (minimum)	0.08 N-mm (zero power)
Recommended Maximum Payload mounted to rotating shaft (Payload must be balanced)	
Mass	3 g
Inertia	350 g-mm ²
CLOSED-LOOP performance (with built-in position sensor)	
Recommended Step Frequency	Up to 100 Hz
Resolution (encoder resolution)	0.025 deg (440 μrad) absolute
Repeatability	+/-0.05 deg (880 μrad)
Accuracy	0.25 deg (4400 μrad)
Maximum Closed-Loop Step & Settle Times (0.99 g-mm ² inertial load*)	
0.5 deg	9 ms
5 deg	14 ms
20 deg	21 ms
OPEN-LOOP performance (external position sensor provided by user)	
Resolution	<0.0057 deg (<100 μrad)
Accuracy	Typically better than 10% of distance travelled after calibration
Maximum Open-Loop Step Times (0.99 g-mm ² inertial load*)	
0.05 deg	0.5 ms
0.5 deg	1.6 ms
5 deg	6 ms
20 deg	10 ms
Input Voltage	3.3 V DC
Power Consumption (typical)	
Input directly to stage	500 mW active, moving 190 mW active, ready 50 mW standby
Input via USB interface (break-out board)	675 mW active, moving 365 mW active, ready 150 mW standby
Stage Mass	3 g
Operational Lifetime	> 2,000,000 random positions**
Temperature/Relative Humidity	0 to +60 C, non-condensing
Communication Interface	I ² C, SPI, UART, analog servo <i>Input directly to M3-RS</i>
Controller	Integrated into stage, 64 MIPS <i>NO external controller needed</i>

* With inertial load of mounted mirror M3-RS-U-Mirror-01-11

Internal Stage Inertia	0.39 g-mm ²
Mirror Clamp	0.45 g-mm ²
Mirror	0.15 g-mm ²
Total Inertia	0.99 g-mm ²

** Significantly longer life may be available depending on the use case. Please consult the factory.

Standard Mounted Mirror (included in kit)

Size	3 x 5 x 0.4 mm
Material	Float Glass
Coating	Protected Aluminum (MgF2)
Operational Bandwidth	0.350 – 4.0 μm
R _{avg} Reflectivity (0.350 – 4.0 μm)	90%
Maximum Beam Diameter	2 mm
Flatness (632 nm)	λ/4 over any 2 mm length
Surface Quality	60 – 40 scratch/dig
CW Damage Threshold (4 μm)	6 W/cm ²
Pulsed Damage Threshold (1 μsec pulses, 350 nm, 20 Hz)	0.3 J/cm ²

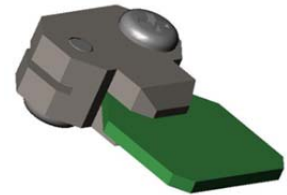

Closed-Loop versus Open-Loop Stepping

An important and standard feature of the M3-RS-U Smart Rotary Stage is the ability to move in using both open-loop and closed-loop commands from the SPI, I2C or UART interface.

Closed-loop stepping

Closed-loop stepping achieves specific shaft angles in minimum increments equal to the resolution of the embedded absolute position sensor. The desired shaft angle is achieved by:

- (1) Receiving the target command from the host processor
- (2) Reading the current shaft angle from the position sensor
- (3) Calculating and commanding the appropriate drive signal for the piezoelectric motor to achieve the desired angle
- (4) Repeating steps (2) and (3) until the target angle is achieved

Closed-loop stepping provides superior repeatability and accuracy, but requires more time to “step and settle” when compared to open-loop stepping.

Open-loop stepping

Open-loop stepping rotates the shaft using only the piezoelectric motor that is commanded to move in “sub-steps.” The magnitude of the sub-steps is smaller than the internal position sensor resolution and allows more precise shaft movement. This is particularly useful in applications that have an external sensor with better resolution than the internal sensor or where very fast “step and settle” performance is required.

Motor sub-steps are commanded from the host processor by defining the Direction, Velocity, and On-time for the piezoelectric motor. The combination of Velocity and On-time determines the magnitude of each sub-step.

Many factors impact the accuracy of open-loop steps including the external load, direction, absolute angle, and magnitude of the step. Options for improving the precision of open-loop stepping include:

- a. Calibration of motor sub-step size for specific operation conditions using an external sensor and fixed look-up table.
- b. Real-time calibration using the internal closed-loop sensor to measure the average size of multiple motor sub-steps.

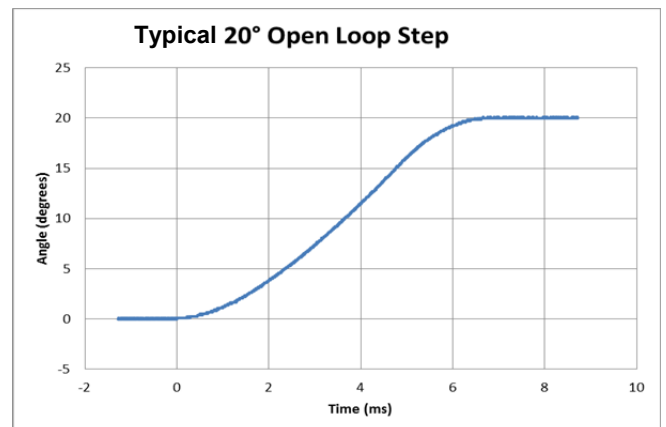
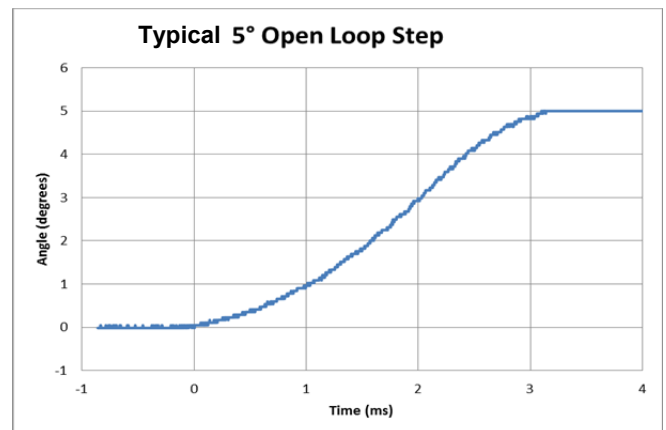
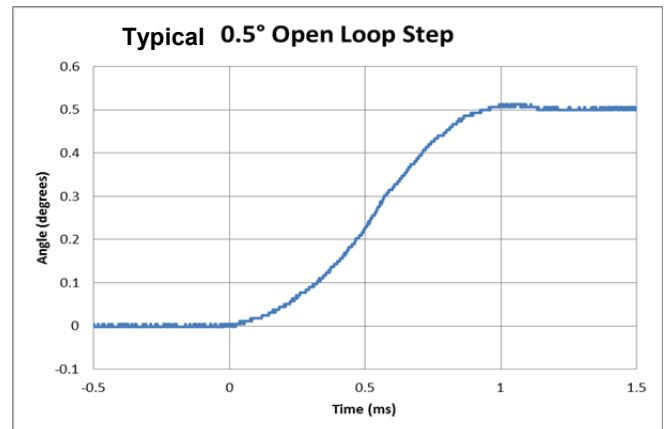
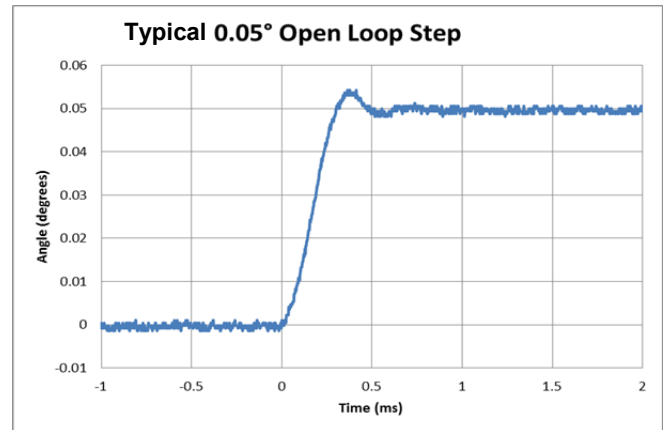

Smart Stage with mounted mirror and base

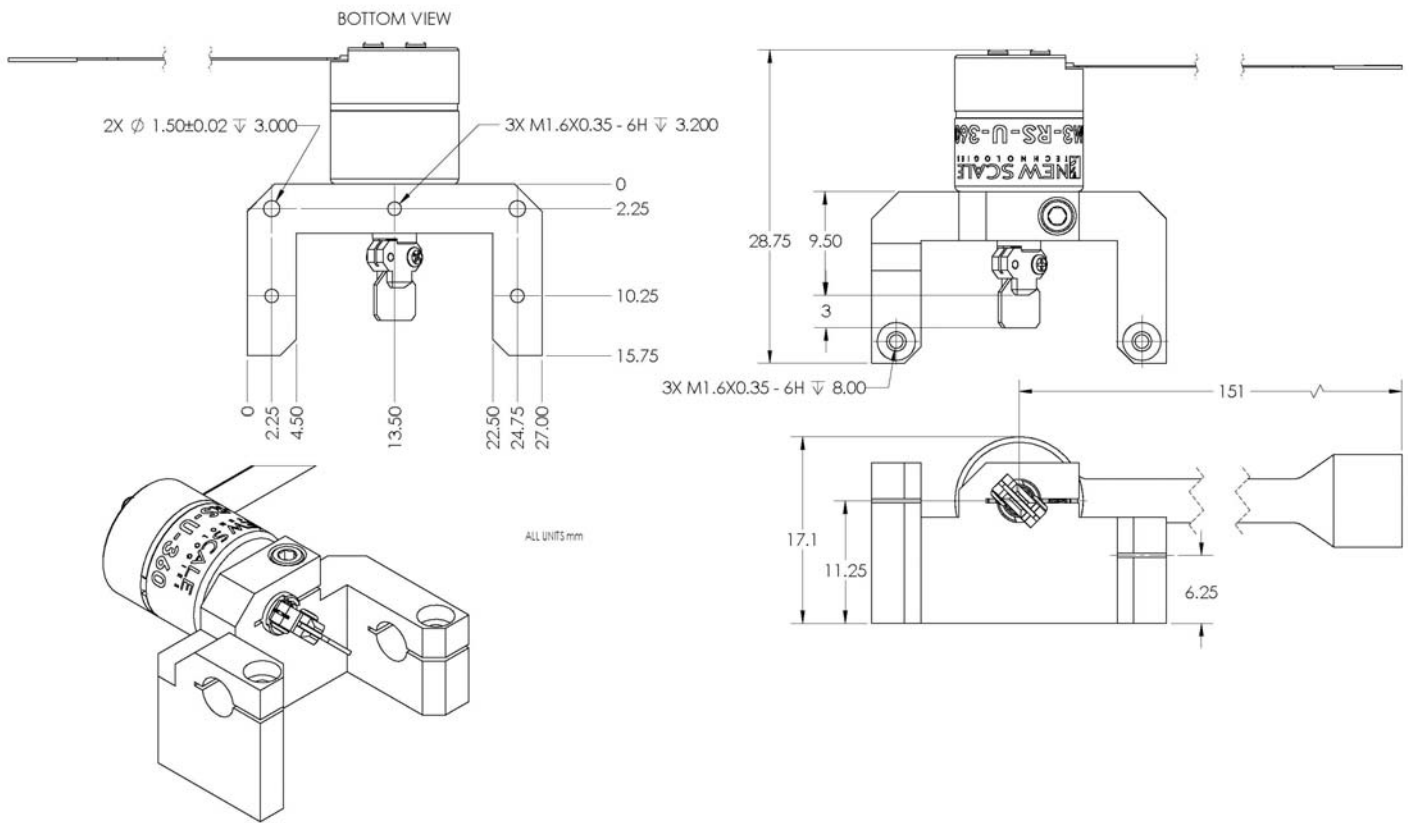

USB adapter and breakout board

Included in the Developer's Kit for evaluation, but not required for mirror positioning

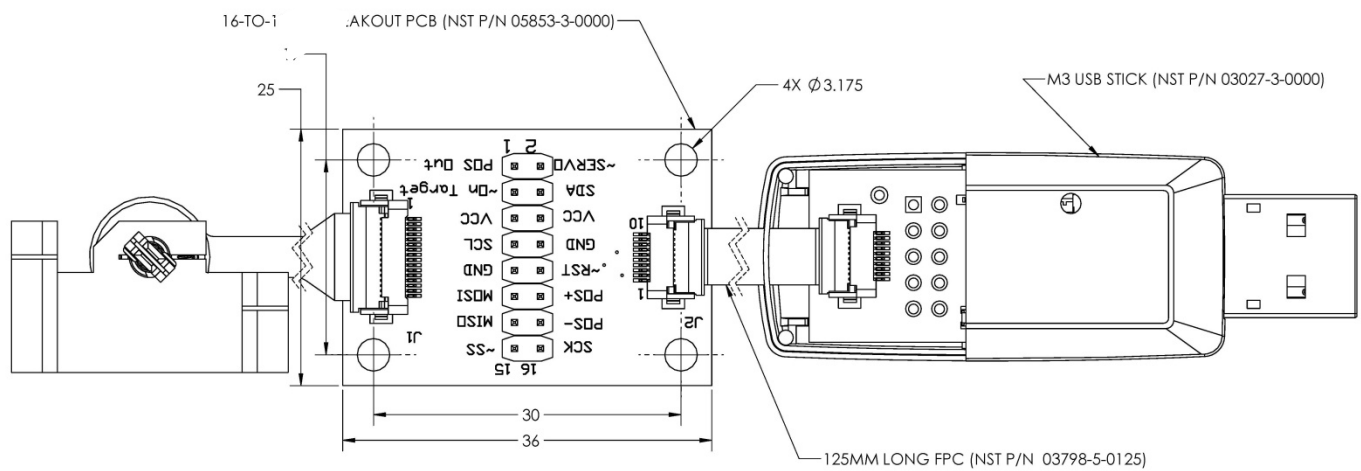

Ordering information

Developer's Kit	Description
DK-M3-RS-U-1M-20	Developer's Kit, Single Axis Mirror Positioning System <ul style="list-style-type: none"> • One M3-RS-U-360 Rotary Stage Positioning Module with embedded controller and straight FPC • One M3-RS-U-Mirror-01-03, mounted to stage • Base • Breakout board for testing and USB connection • Cables and USB adaptor for PC control • New Scale Pathway™ Software
Optional Components	Description
M3-RS-U-360	Rotary Stage Positioning Module Piezo smart stage with built-in controller and M3-RS-U-FPC-0-150 flex cable <i>One stage is included in the kit.</i>
M3-RS-U-Mirror-01-03	Mounted mirror, 3 x 5 x 0.4 mm Inertia 0.50 g-mm ² <i>One, 3-mm mirror is included in the kit.</i>
M3-RS-U-Mirror-01-11	Mounted mirror, 11 x 5 x 0.4 mm Inertia 0.60 g-mm ² <i>One, 3-mm mirror is included in the kit.</i>
M3-RS-U-FPC-0-150	FPC cable with straight exit from stage 150 mm length (standard cable, included with stage)
M3-RS-U-FPC-90-150	FPC cable with 90° exit from stage 150 mm length (optional cable)

Optional components

Mounted Mirrors

Each kit includes one, 3-mm long mounted mirror that is pre-attached to the stage.

You may order additional 3-mm mounted mirrors or longer 11-mm mirrors if desired. Tools to attach the mounted mirrors to the stage are included in the kit.

FPC Cables

Each kit includes two flexible printed circuit cables (one for the stage input and one to connect the adapter board to the USB connector). You may purchase cables in other lengths, with straight or 90-degree exit angles.

Additional Stages

Each kit includes one rotary stage positioning module. Additional modules may be ordered separately.

Additional information

Visit the website for CAD files and user manuals (registration required):

<http://www.newscaletech.com/downloads/software-cad-manuals.php>

----- Remove this page from published PDFs -----

Revision history

Date	Changes
9/3/2015	<ul style="list-style-type: none"> Created
9/10/2015	<ul style="list-style-type: none"> typos
10/9/2015	<ul style="list-style-type: none"> accessory drawing correction – flex cable length and model number pg 1 highlights, added angular resolution
12/8/2015	<ul style="list-style-type: none"> Added open-loop resolution, accuracy to spec table. Added discussion of open-loop vs. closed-loop
4/22/2016	<ul style="list-style-type: none"> Pg. 4, deleted text: <i>“Repeatability and accuracy of open-loop stepping is less than closed-loop stepping.”</i> Spec table: Added payload, mass, inertia information. Changed inertial load Spec table: changed power via USB interface (power for break-out board; had listed power for two-axis demo board) Ordering information, added M3-RS-U-360 stage
9/7/2016	<ul style="list-style-type: none"> Updated figures, callouts, text and drawings to reflect one-piece base (vs. old bracket and base) Spec table: Updated power via USB interface / break-out board Spec table: updated inertial load note to approved -8 documents
9/20/2016	<ul style="list-style-type: none"> Updated photo on page 1
9/30/2016	<ul style="list-style-type: none"> Pg 3 spec table; condition on step & settle corrected inertial load .96 to .99 to match footnote Pg. 6 ordering infor mirror 01-03 inertia corrected 0.45 to 0.50
4-8-2017	<ul style="list-style-type: none"> New logo and color