

Programmable Terminals NT11/NT21

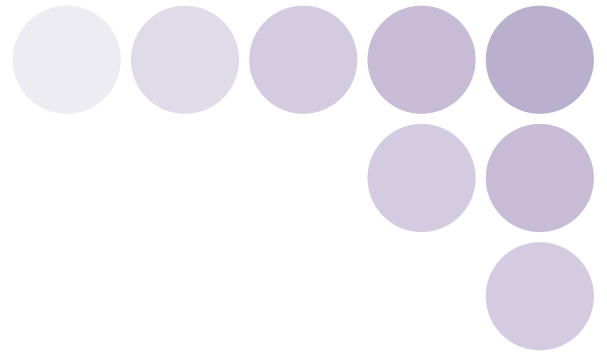

Small and Smart

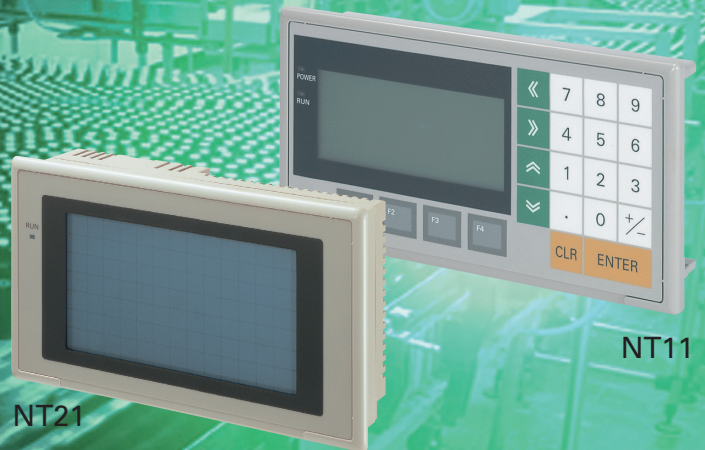

Small and Smart

Compact Size, High Performance

Superb functionality with a compact screen size

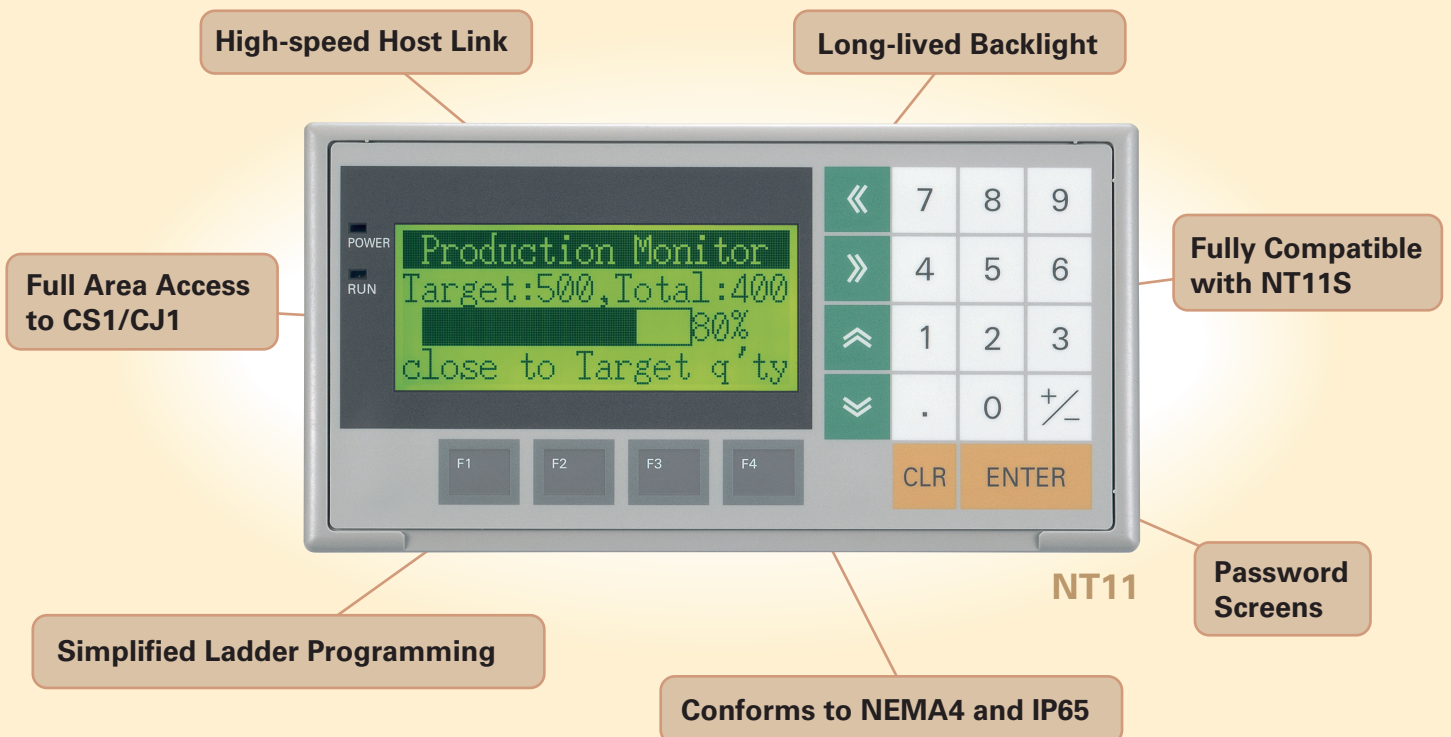
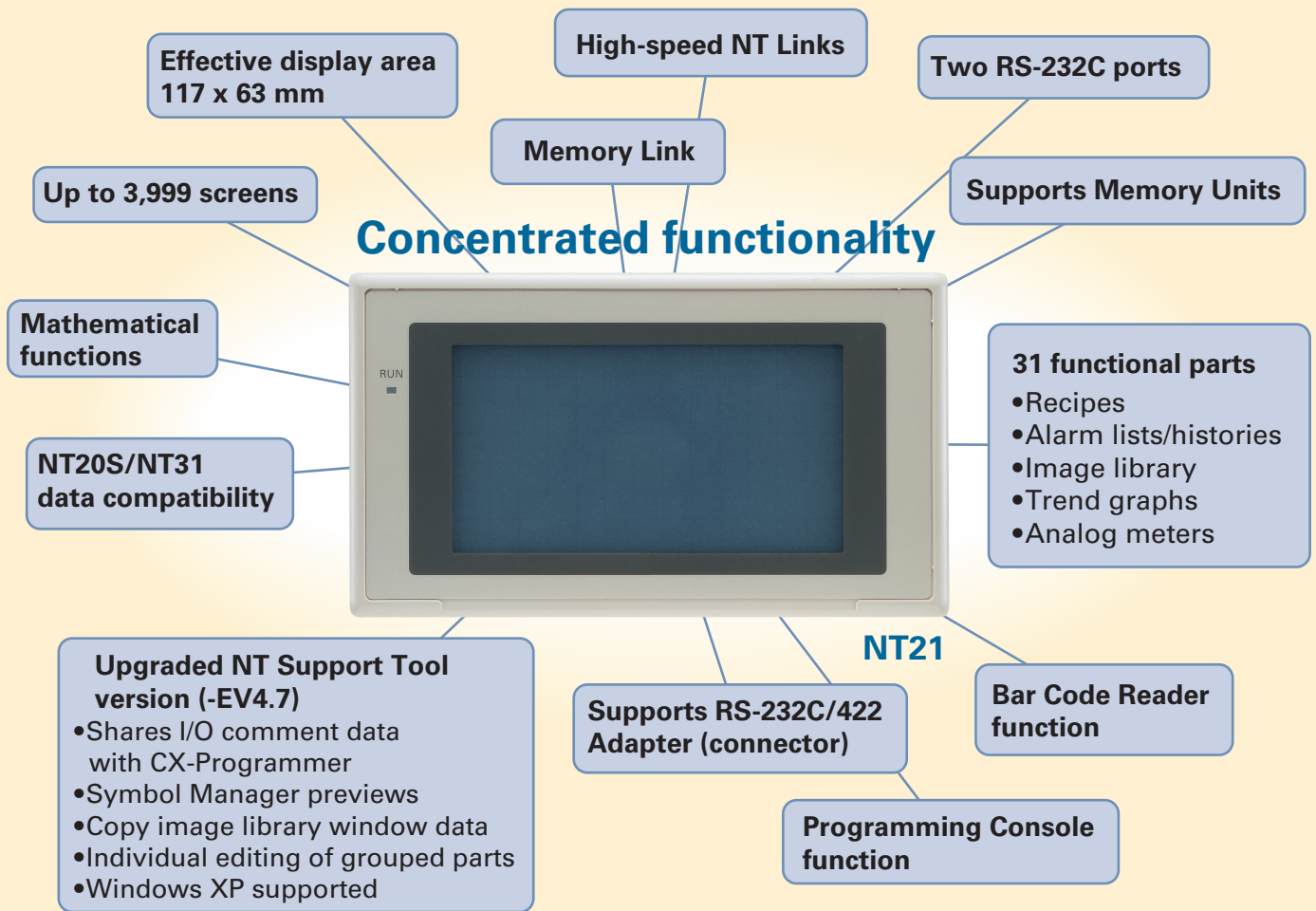

Printout of Production Status

Data such as the production status and production results can be printed out, leaving a record on paper which can be used as a daily report. (The NT11S has a printer port. One screen only is printed.)

Screen	Plan	Prod.
Line 1	200	200
Line 2	150	140
Line 3	350	350



Integral Numeric Key Pad

The display, numeric keys, and function keys are all integrated into the front panel, which is convenient for designers. The key layout is ergonomically designed for ease of use.

High-speed Host Link

Up to 115,200 bps supported between CS1/CJ1 PLCs.

Key Titles can be Marked on the Function Key Sheet

Key titles can be marked on the function key sheet in accordance with the applications of the keys: the sheet can be taken out from the side face of the terminal. The front panel of the terminal has a water-withstanding construction.

Example key titles:



Bar Graphs can be Displayed

Bar graph displays allow the progress of processes to be checked at a glance. (The bars are oriented horizontally.)



Advantages From the Standpoint of Maintenance,

Password Screens for Security

Password screens cannot be accessed unless the correct password is entered. This means that the operations that can be performed can be restricted according to the operator.



Long-lived Backlight

Since LEDs are used for the backlight, it is very long-lived and rarely needs to be changed.

Display History Record Helps in Analysis of Machine Faults

When the display history record function is set as a screen attribute, the time, the screen number, and a comment are recorded in the terminal's memory every time the relevant screen is displayed. This display history can be printed by issuing a print instruction from the host, and is useful for machine fault analysis.

Example printout

No.	Time	Screen No	Screen Comment
1	11/01-10:00	1	LINE ERROR
2	11/07-15:33	15	MOTOR ERROR
3	11/11-13:56	19	COMPRESSER ERROR
4	11/14-09:12	5	MOTOR ERROR

Versatile I/O and Large-capacity Screen Memory in a Space-saving Size

Small Size, Large Screen

The LCD screen is larger than the OMRON NT20S (increased from 256 x 128 dots to 260 x 140 dots), but the external dimensions and panel cut-out size are the same.

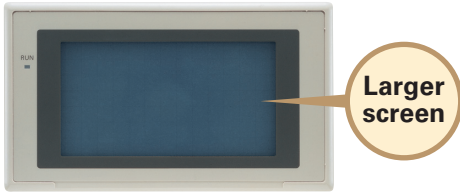

Two RS-232C Ports

Two RS-232C ports in the NT21 (compared with one in the NT20S) enable simultaneous connection of a PLC, Bar Code Reader, and NT Support Tool (connectable to serial port A only).

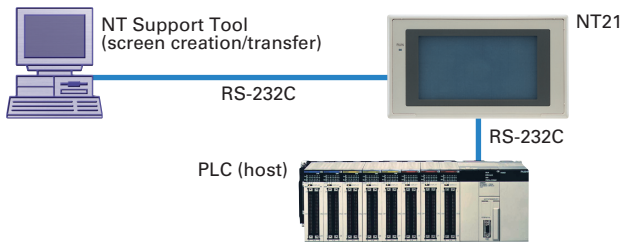

Plenty of Capacity for Saving Graphic Screens

With 512 Kbytes of memory capacity, there is more than ample space for storing screen data.

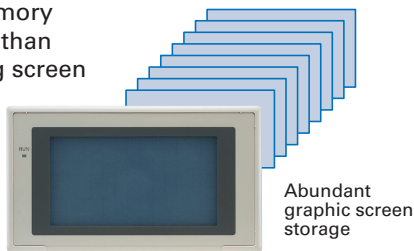

Versatile Communications

In addition to the Host Link and 1:1 NT Link communications, the NT21 supports high-speed 1:N NT Links and Memory Link communications.

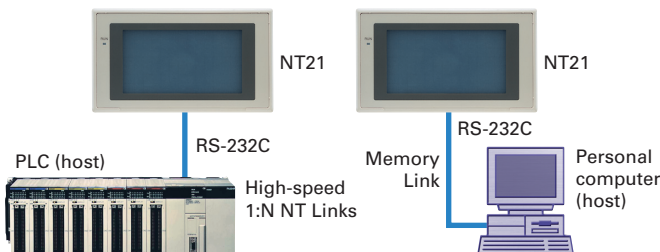

Highly Reliable Hardware

Long, Maintenance-Free Life (50,000 h)

Conforms to International Standards

The NT21 conforms to the EC Directives, as well as UL, cULus (Class 1 Div2), and C-Tick. The front panel has an enclosure rating equivalent to IP65F.

System and screen data can be stored in NT21 Flash Memory.

Function Support Equivalent to That of a Mid-size Operator Interface

Recipe Function

Parts tables on the PT screen can be used to set multiple word data in records, which can then be written to the PLC by a simple PT touch panel operation. For example, the setting parameters for separate models can be edited on the PT, then written to or read from the PLC.

No.	Cake	Cream	Sugar	Egg
1	Cheese	1000	300	20
2	Almond	300	200	10
3	Pound	1000	200	10
4	Carrot	800	150	10
5	Apple	500	300	5
	Write	Read		

Alarm List/History(*)

An alarm message can be displayed in response to PLC bit status, and the content and time of the message can be stored as an alarm history.

Alarm History		Menu
order of occurrence		Reset
Cur. Time	01/09/17 17:24:06	
Battery Error	01/09/17 14:20	▲
Sensor Error	01/09/14 16:15	▲
Feed Error	01/09/12 10:05	▼
Pump Error	01/09/11 11:48	▼

*C500-BAT08 Battery (sold separately) required.

Programming Console Function

The NT21 is equipped with many of the same functions as the PLC Programming Console.

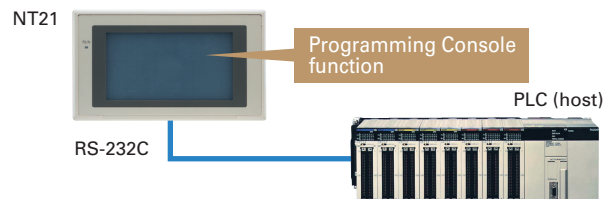

Mathematical Functions

Up to 256 math equations can be stored in the PT processing table to allow automatic PT processing, and the results can be written to the numeral memory table or other destinations. This makes it possible to perform scaling and other mathematical operations automatically in the PT.

Upgraded NT Support Tool Version (-EV4.7)

Enhanced Editing Functions

- I/O comments in the I/O tables of the CX-Programmer can be used directly.

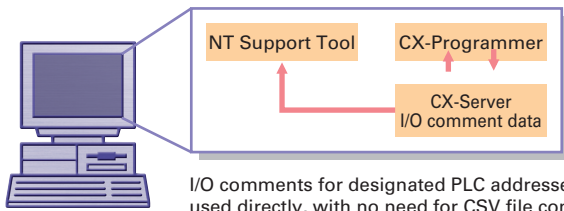

- Symbol Manager previews are supported. This function makes it possible to preview symbols (parts created from graphics data).
 - Parts can be copied by drag & drop operations of image, library, or mark data.
 - The properties of grouped parts can be edited without having to ungroup them.
 - Because NT20S and NT31 screen data is compatible with the NT21, existing software assets can be utilized to greatly reduce the number of design steps.
- Note:** Some data revisions may be required due to size differences.
- Windows XP supported.

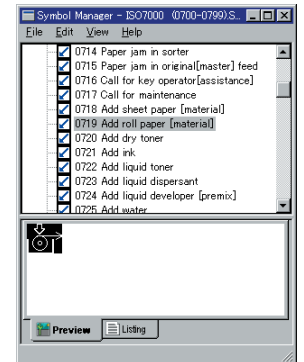

Comparison with the NT11

	Model	NT11	NT11S	NT21	NT20S
Basic performance	Dimensions	218 x 113 x 38.2 mm (H x W x D)		190 x 110 x 53.5 mm (H x W x D)	
	Resolution	160 x 64 dots (4.24 inches)		260 x 140 dots (5.2 inches)	256 x 128 dots (4.91 inches)
	Effective display area	100 x 40 mm		117 x 63 mm	112 x 56 mm
	Display color	Black & white (with Yellow mode)		Black & white (with blue mode)	
	Panel cut-out size (W x H)	204.2 x 99.8 mm		178.5 x 100.5 mm	
	Max. number of registered screens	250		3,999	500
	Screen data capacity	32 KB		512 KB	96 KB
	Function keys	4		None	None
	Other Keys	Numeric Keys, Cursor Keys, Function Keys		None	None
Display elements	Rectangles, polygons, arcs, sectors	None		Supported	None
	Painting out	None		Supported	None
	Image/library displays	None		256 positions per screen	None
	Analog meters	None		50 positions per screen	None
	Trend graphs	None		1 position per screen	None
	Broken line graphs	None		1 position per screen	None
	Alarm lists/histories	None		4 positions per screen	None
	Recipes	None		1 position per screen	None
Special functions	Interlocks	None		Supported	None
	Mathematical Function	None		Math equations: Max. 256 (arithmetic functions, logic operations, bit manipulations, comparison operations)	None
	Programming Console function	None		(Executes functions equivalent to C200H-PR027 and CS1 Programming Consoles.)	None
	High-quality font	None		Supported	None
	Memory Unit	None (Emergency transfer mode)*		Supported	None
	Backlight service life	50,000 hours min.	10,000 hours min.	50,000 hours min.	10,000 hours min.
Communications	Memory Links	None		Supported	Via RS-232C communications
	Bar Code Reader connection	None		Supported	None
	Host Link Speed	Up to 115,200	9,600/19,200	9,600/19,200	9,600/19,200

*Emergency transfer mode: When power to the NT11 is turned ON with DIP switch pin 3 turned ON, data transfer mode can be entered directly without any other operation.

■ NT11 General Specifications

Item	Specification
Power supply voltage	24 VDC
Allowable power supply voltage range	20.4 to 27.6 VDC (24 VDC -15%, +15%)
Power consumption	10 W max.
Noise resistance	Conforms to IEC61000-4-4, 2K (power lines)
Vibration resistance	10 to 57 Hz with 0.075 mm amplitude and 57 to 150 Hz with 9.8 m/s ² acceleration for 30 min in each of X, Y, and Z directions
Shock resistance	147 m/s ² 3 times in each of X, Y, and Z directions
Ambient operating temperature	0 to +50°C
Ambient operating humidity	35 to 85% RH (with no condensation)
Operating environment	No corrosive gasses.
Storage temperature	-20 to +70°C (with no freezing)
Enclosure ratings	Front panel: Equivalent to IP65, NEMA4
Weight	1.0 kg max.

■ Display/Panel Specifications

Note: In order to improve the performance of displays, liquid crystal devices may be changed without notice.

Item	Specification
Display screen	<ul style="list-style-type: none"> Dot matrix of STN liquid crystal display panel Number of dots: 160 x 64 Effective display area: 100 x 40 mm Life expectancy: 50,000 hours minimum View angle (left/right direction): ±20°
Indicators	<ul style="list-style-type: none"> Backlight LED Life expectancy: 50,000 hours minimum Automatic turn-off: can be set to turn off in 10 minutes or 1 hour, or to remain on.
Switch	<ul style="list-style-type: none"> POWER indicator (Green LED): Lit while power is being supplied. RUN indicator (Green LED): Lit during operation
Switch	<ul style="list-style-type: none"> 22 switches Life expectancy: 1 million operations minimum

■ Display Capacity

Note: In order to improve the performance of displays, liquid crystal devices may be changed without notice.

Item	Specification	
Display characters	Normal characters (8 x 16 dots): Alphanumerics and symbols Marks (8 x 16 dots): User-defined, 64 max.	
Number of characters displayed	Normal-size: 20 horizontally x 4 lines vertically max.	
Enlargement function	Double width	
Display elements	Character string displays	8 positions per screen
	Numerical displays	8 positions per screen
	Graph displays	4 positions per screen
	Numerical settings	8 positions per screen
Screen attributes	Display history	Order of frequency, 256 screens
	Password screen	Ensures security: screens for which this attribute is set can only be displayed if the correct password is input.
	Menu screen	Four items per screen
Screen types	Normal screen: Displays screen registered as normal.	
Max. number of registered screens	250	
Screen registration method	Transfer screen data created using an IBM PC/AT personal computer to the PT.	
Screen saving method	Saved to flash memory: 32 KB (downloading method)	

■ Special Features

Item	Specification
Printing function	<ul style="list-style-type: none"> Printing of display history data Printing of daily reports (printing format registered by the users)
Maintenance functions	<ul style="list-style-type: none"> Self-test for memory, switches, etc. Status setting confirmation for communications and other conditions. Simple communications confirmation.

■ NT11 Product Configurations

Product	Specification	Model	
Programmable Terminal*	Host link direct connection, NT link method	Ten-key type (frame color: beige)	NT11-SF121-EV1
		Ten-key type (frame color: black)	NT11-SF121B-EV1
Support Software	CD-ROM (for Windows 95, 98, Me, XP, NT, 2000)		NT-ZJCAT1-EV4
Function key sheet		10 sheets for replacement for beige	NT11-CKF01
		10 sheets for replacement for black	NT11-CKF01B

*The PT body incorporated the communication interface, screen memory, and a flash ROM that downloads the system program.

*Connecting cables with the PLC and NTST are the same as those for the NT21. Please refer to the next page.

■ Outside Dimensions

(Unit: mm)

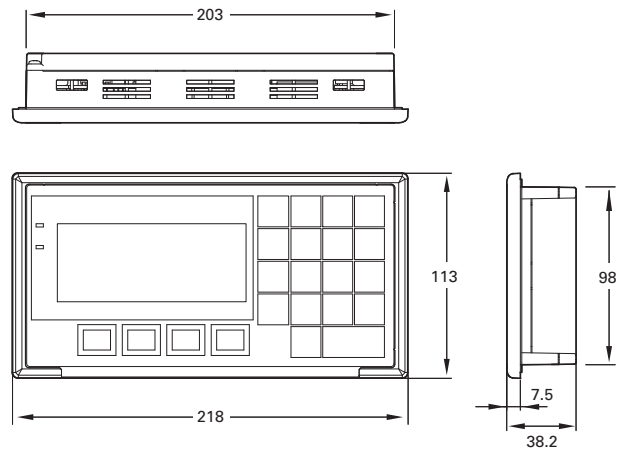

■ Panel Plate thickness: 1.6 to 4.8 mm

■ Recommended panel cutout:

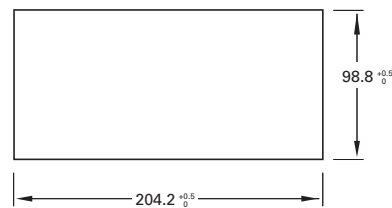

■ Rear face

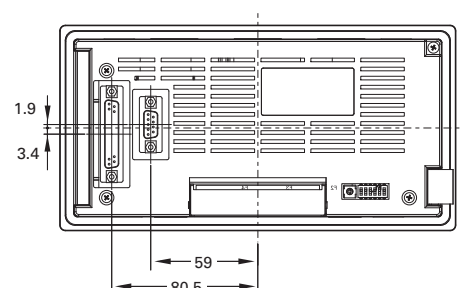

■ NT21 General Specifications

Item	Specification
Power supply voltage	24 VDC 15%
Power consumption	7 W max.
Noise resistance	Conforms to IEC61000-4-4. Power supply line: 2 kV
Vibration resistance	10 to 57 Hz with 0.075-mm single amplitude, 57 to 150 Hz with 9.8 m/s ² acceleration, for a total of 60 min in X, Y, and Z directions
Shock resistance	Peak acceleration 15 G, 3 times each in X, Y, and Z directions
Ambient operating temperature	0 to 50°C (with no icing)
Storage temperature	-20 to +70°C (with no icing)
Ambient operating humidity	35% to 85% (with no condensation)(0 to 40°C) 35% to 55% (with no condensation)(40 to 50°C)
Dimensions	190 x 110 x 53.5 mm (W x H x D) (thickness inside panel: 49.0 mm)
Enclosure ratings	Front panel operating section: Equivalent to IP65F, NEMA 4.*
Weight	0.6 kg max.

*Usage may not be possible in places where the unit would be exposed to oil for long periods.

■ Display Capacity

Item	Specification	
Display elements	Fixed displays	A total of 65,535 per screen (Graphics: Continuous straight lines, rectangles, circles, polygons, arcs, sectors)
	Fixed character strings	With overlapping screens, the total is 524,280 per screen
	Graphics	
	Marks	
	Numeral displays	256 positions per screen, max. 10-digit display (2 words)
	Character string displays	256 positions per screen, max. 1,024 display elements for overlapping screens
	Graph displays	50 positions per screen, capable of displaying signs and percentages
	Analog meters	50 positions per screen, capable of displaying signs and percentages
	Trend graphs	One frame per screen, 50 items per frame (8 items max. for data logging)
	Broken line graphs	One frame per screen, 256 items per frame, 260 points per item
	Lamps	256 positions per screen
	Image library images	256 positions per screen
	Touch switches	256 positions per screen, max. 256 meshes
	Numeral settings	256 positions per screen (numerical key pad)
Thumbwheel settings	26 positions per screen	
Character string settings	256 positions per screen	
Temporary inputs	One position per screen	
Alarm lists/histories	Four groups per screen	
Screen types	Recipes	One position per screen
	Normal screens	Displays screens registered as normal
	Overlapping screens	A maximum of eight screens can be displayed overlapping each other.
	Windows	Up to three window screens can be displayed.
	Display history screens	Order of occurrence (1,024 screens max.), order of frequency (255 times max.)
	System startup screen	Displayed when powering ON (or resetting) the PT, and when switching to RUN mode.
	Programming Console screen	Emulates PLC Programming Console functions, capable of being called from RUN mode.
Screen attributes	Buzzer, display history, normal background colors, backlight mode, local windows	
Number of screens	Max. number of registered screens	3,999
	Screen number	0: No display 1 to 3999: User registered screens (normal, overlapping, windows) 9000: System startup screen 9001: Display history screens, order of occurrence 9002: Display history screens, order of frequency 9020: Programming Console screen 9021 to 9023, 9030: Reserved 9999: Return to previous screen designation
Screen registration method	By transferring screen data from the NT Support Tool to the PT via serial communications By mounting the Memory Unit and downloading (automatic/manual transfer) data to the PT	
Saving screen data	Flash memory (PT internal image memory)	

■ Display Specifications

Item	Specification	
Display panel	Display device	Monochrome STN LCD
	Number of dots (resolution)	260 dots horizontally x 140 dots vertically
	Effective display area	117 mm horizontally x 63 mm vertically
	Viewing angle	Left/right direction: 30°, up/down: 30°
	Display color	Black & white (with blue mode)
	Service life	50,000 hours min. (until contrast reduced to 50%)
Backlight (white cold cathode tube)	Automatic turn-OFF	Can be set to turn OFF in 1 to 255 min or to remain ON with screen saver
	Service life	50,000 hours min. (at room temperature, until brightness is reduced to 50%)
	Replacement	Non-replaceable

■ Panel Specifications

Item	Specification	
Touch panel	Number of switches	91 (13 horizontally x 7 vertically)
	Input	Pressure-sensitive
	Threshold force for operation	1 N max.
	Life expectancy	1 million operations min.

■ External Interface Specifications

Communications method	Serial port A	Serial port B
NT Support Tool	Supported	Not supported
PLC	Host Link	Supported
	1:1 NT Link	Supported
	1:N NT Links	Supported
	NT Link, PT Programming Console function	Supported
SBC/personal computer	Memory Links	Supported
Bar Code Reader		Supported

*Connection via RS-422A/485 is possible using the NS-AL002 RS-232C/422A Adapter (connector), which can be connected only to serial port B. (RS-485 connections must use 1:N NT Links.)

■ NT21 Standard Models

Product	Specification	Model number	
NT21 Programmable Terminal	Monochrome STN	Frame color: beige NT21-ST121-E Frame color: black NT21-ST121B-E	
	Support Tool	Windows 95, 98, Me, NT, or 2000 CD-ROM NT-ZJCAT1-EV4	
Cables	For screen transfer		
	For PLC connection	PT: 9-pin PLC: 9-pin	Cable length: 2 m XW2Z-200T Cable length: 5 m XW2Z-500T
		PT: 9-pin PLC: 25-pin	Cable length: 2 m XW2Z-200S Cable length: 5 m XW2Z-500S
		PT: 9-pin PLC: Mini-peripheral	Cable length: 2 m XW2Z-200T-2 Cable length: 5 m XW2Z-500T-2
		Reflection Protective Sheets	Display area only (5 sheets) NT20M-KBA04
		Chemical-resistive Cover	Silicon cover NT20S-KBA01
Battery		For alarm lists/histories C500-BAT08	
Options	Memory Unit	For screen and system data transfer NT-MF161	
	RS-232C/422A Adapter	NS-AL002	
	Connector Kit	XM2S-0911-S003	

■ Dimensions

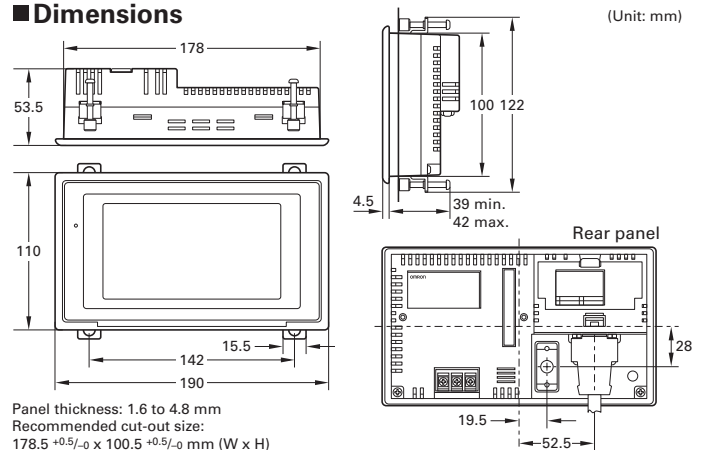

Terms and Conditions Agreement

Read and Understand this Catalog

Please read and understand this catalog before purchasing the products. Please consult your OMRON representative if you have any questions or comments.

Warranty and Limitations of Liability

WARRANTY

- (a) Exclusive Warranty. Omron's exclusive warranty is that the Products will be free from defects in materials and workmanship for a period of twelve months from the date of sale by Omron (or such other period expressed in writing by Omron). Omron disclaims all other warranties, express or implied.
- (b) Limitations. OMRON MAKES NO WARRANTY OR REPRESENTATION, EXPRESS OR IMPLIED, ABOUT NON-INFRINGEMENT, MERCHANTABILITY OR FITNESS FOR A PARTICULAR PURPOSE OF THE PRODUCTS. BUYER ACKNOWLEDGES THAT IT ALONE HAS DETERMINED THAT THE PRODUCTS WILL SUITABLY MEET THE REQUIREMENTS OF THEIR INTENDED USE.

Omron further disclaims all warranties and responsibility of any type for claims or expenses based on infringement by the Products or otherwise of any intellectual property right. (c) Buyer Remedy. Omron's sole obligation hereunder shall be, at Omron's election, to (i) replace (in the form originally shipped with Buyer responsible for labor charges for removal or replacement thereof) the non-complying Product, (ii) repair the non-complying Product, or (iii) repay or credit Buyer an amount equal to the purchase price of the non-complying Product; provided that in no event shall Omron be responsible for warranty, repair, indemnity or any other claims or expenses regarding the Products unless Omron's analysis confirms that the Products were properly handled, stored, installed and maintained and not subject to contamination, abuse, misuse or inappropriate modification. Return of any Products by Buyer must be approved in writing by Omron before shipment. Omron Companies shall not be liable for the suitability or unsuitability or the results from the use of Products in combination with any electrical or electronic components, circuits, system assemblies or any other materials or substances or environments. Any advice, recommendations or information given orally or in writing, are not to be construed as an amendment or addition to the above warranty. See <http://www.omron.com/global/> or contact your Omron representative for published information.

LIMITATIONS OF LIABILITY

OMRON COMPANIES SHALL NOT BE LIABLE FOR SPECIAL, INDIRECT, INCIDENTAL, OR CONSEQUENTIAL DAMAGES, LOSS OF PROFITS OR PRODUCTION OR COMMERCIAL LOSS IN ANY WAY CONNECTED WITH THE PRODUCTS, WHETHER SUCH CLAIM IS BASED IN CONTRACT, WARRANTY, NEGLIGENCE OR STRICT LIABILITY.

Further, in no event shall liability of Omron Companies exceed the individual price of the Product on which liability is asserted.

Application Considerations

SUITABILITY FOR USE

Omron Companies shall not be responsible for conformity with any standards, codes or regulations which apply to the combination of the Product in the Buyer's application or use of the Product. At Buyer's request, Omron will provide applicable third party certification documents identifying ratings and limitations of use which apply to the Product. This information by itself is not sufficient for a complete determination of the suitability of the Product in combination with the end product, machine, system, or other application or use. Buyer shall be solely responsible for determining appropriateness of the particular Product with respect to Buyer's application, product or system. Buyer shall take application responsibility in all cases.

NEVER USE THE PRODUCT FOR AN APPLICATION INVOLVING SERIOUS RISK TO LIFE OR PROPERTY OR IN LARGE QUANTITIES WITHOUT ENSURING THAT THE SYSTEM AS A WHOLE HAS BEEN DESIGNED TO ADDRESS THE RISKS, AND THAT THE OMRON PRODUCT(S) IS PROPERLY RATED AND INSTALLED FOR THE INTENDED USE WITHIN THE OVERALL EQUIPMENT OR SYSTEM.

PROGRAMMABLE PRODUCTS

Omron Companies shall not be responsible for the user's programming of a programmable Product, or any consequence thereof.

Disclaimers

PERFORMANCE DATA

Data presented in Omron Company websites, catalogs and other materials is provided as a guide for the user in determining suitability and does not constitute a warranty. It may represent the result of Omron's test conditions, and the user must correlate it to actual application requirements. Actual performance is subject to the Omron's Warranty and Limitations of Liability.

CHANGE IN SPECIFICATIONS

Product specifications and accessories may be changed at any time based on improvements and other reasons. It is our practice to change part numbers when published ratings or features are changed, or when significant construction changes are made. However, some specifications of the Product may be changed without any notice. When in doubt, special part numbers may be assigned to fix or establish key specifications for your application. Please consult with your Omron's representative at any time to confirm actual specifications of purchased Product.

ERRORS AND OMISSIONS

Information presented by Omron Companies has been checked and is believed to be accurate; however, no responsibility is assumed for clerical, typographical or proofreading errors or omissions.

Note: Do not use this document to operate the Unit.

OMRON Corporation Industrial Automation Company
Kyoto, JAPAN

Contact: www.ia.omron.com

Regional Headquarters

OMRON EUROPE B.V.

Wegalaan 67-69, 2132 JD Hoofddorp
The Netherlands
Tel: (31)2356-81-300/Fax: (31)2356-81-388

OMRON ASIA PACIFIC PTE. LTD.

No. 438A Alexandra Road # 05-05/08 (Lobby 2),
Alexandra Technopark,
Singapore 119967
Tel: (65) 6835-3011/Fax: (65) 6835-2711

OMRON ELECTRONICS LLC

2895 Greenspoint Parkway, Suite 200
Hoffman Estates, IL 60169 U.S.A.
Tel: (1) 847-843-7900/Fax: (1) 847-843-7787

OMRON (CHINA) CO., LTD.

Room 2211, Bank of China Tower,
200 Yin Cheng Zhong Road,
PuDong New Area, Shanghai, 200120, China
Tel: (86) 21-5037-2222/Fax: (86) 21-5037-2200

Authorized Distributor:

© OMRON Corporation 2015 All Rights Reserved.
In the interest of product improvement,
specifications are subject to change without notice.

CSM_1_1_0915

Cat. No. V071-E1-03

0815 (1003)