

Thank you for purchasing the HAKKO FR-830 Preheater.  
Please read this manual before operating the HAKKO FR-830.  
Keep this manual readily accessible for reference.

**CAUTION**

- Maintain a minimum clearance of 10 mm between a PWB and the hot air outlet.
- Do not cover the hot air outlet while hot air is blowing from the outlet.
- Do not blow heated air directly into the hot air outlet when the upper unit is used.
- Do not turn off the power until cool down is completed after the heater is turned off.

**1. PACKING LIST & PART NAMES**

Please check to make sure that all items listed below are included in the package.

HAKKO FR-830.....	1	Instruction manual.....	1
Power cord.....	1		

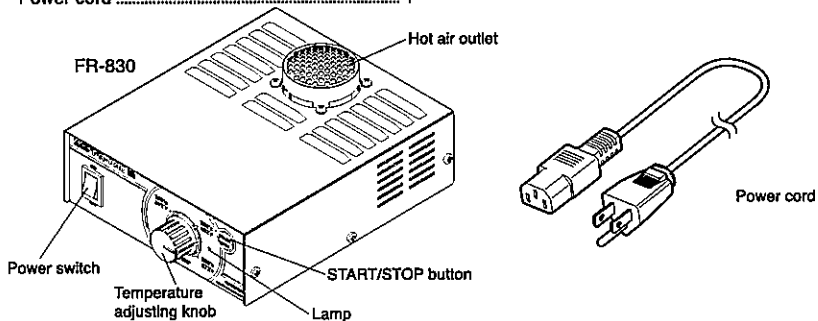

**2. SPECIFICATIONS**

● HAKKO FR-830 Preheater

Power Consumption	100V-210W, 110V-240W, 120V-470W 220V-230W, 230V-250W, 240V-270W
Control Temperature	150 - 300°C(302 - 572°F) (above the hot air outlet)
Dimensions	140(W) X 75*(H) X 185(D) mm (5.5 X 3.0 X 7.3 in.)
Weight	750 g (1.653 lb)
Air Flow	0.15m³/min (fan capability)

- \* Height (H) is the distance from the bottom of the foot to the top of the hot air outlet.
- \* This product is protected against electrostatic discharge. Be sure to ground the unit during use.
- \* Specifications and design are subject to change without notice.

■ Electrostatic Protection

This product includes such features as electrically conductive plastic parts and grounding of the unit as measures to protect the device to be soldered from the effects of static electricity. Be sure to observe the following instructions:

1. The plastic parts are not insulators, they are conductors. When making repairs or replacing parts, take sufficient care not to expose live electrical parts or damage insulation materials.
2. Be sure to ground the unit during use.

※ 各言語 (日本語、英語、中国語、フランス語、ドイツ語、韓国語) の取扱説明書は以下のURL、HAKKO Document Portalからダウンロードしてご覧いただけます。  
(商品によっては設定の無い言語がありますが、ご了承ください)  
※ 各言語(日語、英語、中文、法語、獨語、韓語)の使用説明書は以下のURL、HAKKO Document Portal 下載參閱。  
(有一部分的产品没有设定外语對應圖說)  
• Instruction manual in the language of Japanese, English, Chinese, French, German and Korean can be downloaded from the HAKKO Document Portal.  
(Please note that some languages may not be available depending on the product.)

<https://doc.hakko.com>

**HAKKO CORPORATION**  
HEAD OFFICE  
TEL:+81-6-6561-3225 FAX:+81-6-6551-8486  
<http://www.hakko.com> E-mail:sales@hakko.com  
OVERSEAS AFFILIATES  
U.S.A.: AMERICAN HAKKO PRODUCTS, INC.  
TEL: (981) 294-0090 FAX: (981) 294-0096  
Toll Free (800)88-HAKKO  
<http://www.hakko.us.com>  
HONG KONG: HAKKO DEVELOPMENT CO., LTD.  
TEL: 2811-6588 FAX: 2950-0217  
<http://www.hakko.com.hk>  
E-mail:info@hakko.com.hk  
SINGAPORE: HAKKO PRODUCTS PTE., LTD.  
TEL: 6748-2277 FAX: 6744-0033  
<http://www.hakko.com.sg>  
E-mail:sales@hakko.com.sg

Please access to the following address for the other Sales affiliates.  
<http://www.hakko.com>

中國RoHS: 產品中有毒有害物質或元素的名稱及含量

部件名稱	有毒有害物質或元素					
	鉛(Pb)	汞(Hg)	鎘(Cd)	六價鉻(Cr(VI))	多溴聯苯(PBB)	多溴二苯醚(PBDE)
風扇	×	○	○	○	○	○
電路板	×	○	○	○	○	○
發熱元件組品	×	○	○	○	○	○
插頭	×	○	○	○	○	○

○: 表示該有毒有害物質在該部件所有均質材料中的含量均在EU/T 11363-2006標準規定的限量要求以下。  
×: 表示該有毒有害物質至少在該部件的某一均質材料中的含量超出EU/T 11363-2006標準規定的限量要求。

**3. WARNINGS, CAUTIONS, AND NOTES**

Warnings, cautions and notes are placed at critical points in this manual to direct the operator's attention to significant items. They are defined as follows:

- ⚠ **WARNING:** Failure to comply with a WARNING may result in serious injury or death.
- ⚠ **CAUTION:** Failure to comply with a CAUTION may result in injury to the operator, or damage to the items involved.
- NOTE : A NOTE indicates a procedure or point that is important to the process being described.

**CAUTION**

When the power is ON, the temperature of the hot air outlet ranges from 150 to 300°C (302 to 572°F). To avoid injury to personnel or damage to items in the workarea, observe the following:

- Do not directly touch either the hot air outlet or its vicinity.
- Do not use the product near combustible gases or flammable materials.
- Do not spray flammable substances or flux to the hot air outlet or the air inlet.
- Do not put foreign objects into the hot air outlet or the air inlet.
- Do not use the unit in an enclosed area, and with the hot air outlet or the air inlet blocked.
- Inform others in the area that the unit is hot and should not be touched.
- Turn the power off when not in use, or left unattended.
- Turn the power off when changing parts or storing the HAKKO FR-830.
- Do not use the HAKKO FR-830 in the vicinity of anything which can be pulled into the air inlet and cause a fire (such as dust and dirt).
- This appliance is not intended for use by persons (including children) with reduced physical, sensory or mental capabilities, or lack of experience and knowledge, unless they have been given supervision or instruction concerning use of the appliance by a person responsible for their safety.
- Children should be supervised to ensure that they do not play with the appliance.

● This product is approved for use as a PWB preheater. Misuse of this product may result in injury.

- Do not use the HAKKO FR-830 for applications other than preheating.
- Do not blow air into the hot air outlet from above.
- For maximum service life, limit continuous operation to no more than 1 hour.
- Be sure the HAKKO FR-830 is grounded. Always connect power to a grounded receptacle.
- Do not modify the HAKKO FR-830.
- Use only genuine HAKKO replacements parts.
- Do not allow the HAKKO FR-830 to become wet, or use it when hands are wet.
- Remove power cord by holding the plug - not the wires.
- While using the HAKKO FR-830, don't do anything which may cause bodily harm or physical damage.

**4. OPERATION**

● Preparation

Place the PWB over the FR-830.  
(See figure to the right for reference)

⚠ **CAUTION**  
Please make sure to keep 10 mm or more gap between the PWB and the hot air outlet.

● Turn on the power.

1. Insert the power cord into the receptacle.
2. Turn on the power switch.  
The lamp comes on in green and room temperature air is discharged.

⚠ **CAUTION**

Make sure that the hot air outlet and its vicinity are not blocked before turning on the power switch.

3. Set the desired temperature of the air.
4. Press the START/STOP button to start preheating. The lamp comes on in red. Hot air is discharged from the hot air outlet. When the temperature stabilizes, the lamp will start flashing.

● After finishing the work

1. Press the START/STOP button to stop preheating. The heater operation stops and cool down of the unit begins. The lamp flashes slowly in green. After the cool down is complete, the lamp comes on in green and the unit is ready to start again.

2. Make sure that the unit is completely cooled down before turning off the power switch.

● Temperature Offset Function

When setting a temperature offset, be sure to measure the hot air at a point that is approximately 5mm above the center of the hot air outlet.

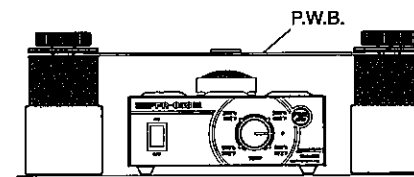

● To start working

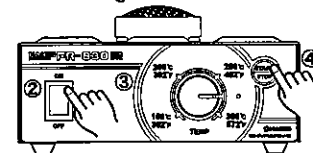

● To finish working

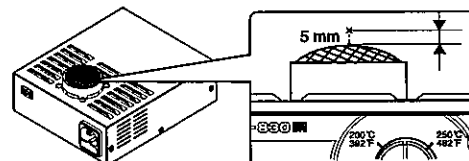
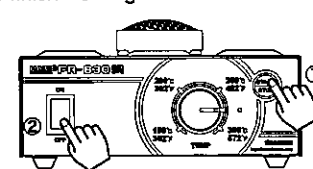

**4. OPERATION**

● Temperature Offset Function (continued)

1. Turn the temperature adjusting knob to 250°C and wait until the measured temperature is stabilized.
2. After the temperature stabilizes, press the START/STOP button for three seconds. The color of the lamp will change to orange.
3. Turn the knob so that the measured temperature indicates 250°C. The temperature offset ranges from -50°C to +50°C relative to the initial setting. Once the temperature is offset by +10°C, the temperature offset range is from -60°C to +40°C.
4. Press the START/STOP button again. The lamp returns to red, which indicates that an automatic control of the heater begins. Turn the knob to the desired temperature for preheating.

⚠ **CAUTION**

If you try to make a temperature offset with the knob being set at 150°C or 300°C, the temperature cannot be offset in the negative (-) direction or in the positive (+) direction respectively.

⚠ **CAUTION**

The temperature offset function does not work unless the temperature stabilizes.

⚠ **CAUTION**

If you try to make a temperature offset that exceeds +/-50°C, the lamp will start flashing. Temperature offset cannot be made while the lamp is flashing.

⚠ **CAUTION**

The unit automatically switches to the normal operation mode unless you turn the knob within 90 seconds after entering the temperature offset mode.

**5. ERROR INDICATION**

When a fault is detected, the lamp on the front panel flashes in the following pattern indicating a fault occurs.

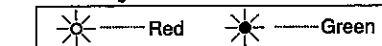

● Heater Error

Lamp flashing pattern:  
\*\*\*\*\*

There are two causes that the heater error will occur.  
● The heater error occurs when hot air is blown into the air outlet and the heater protection is activated.  
The heater error due to activation of the protection system is automatically reset when turning the power OFF and the unit is cooled.  
● The heater error occurs if the heater is broken and the temperature is not increased. Refer to "7. TROUBLESHOOTING".

● Sensor Error

Lamp flashing pattern:  
\*\* \*\* \*

The sensor error occurs if the sensor is broken.

● Overheat Error

Lamp flashing pattern: (fast flashing)  
\*\*\*\*\*

The overheat error occurs when the unit temperature is abnormally high. When the unit cools, the error will be cleared automatically and function of the unit will resume.

● System Error

Lamp flashing pattern:  
\*\*\*\*\*

When a problem has occurred to the control system, a system error occurs.

**6. MAINTENANCE**

Remove any flux or other residue that may stick to the hot air outlet by wiping it off.

## 7. TROUBLESHOOTING

### ⚠ WARNING

- Before checking the inside of the HAKKO FR-830 or replacing parts, be sure to disconnect the power plug. Failure to do so may result in electric shock.
- Perform troubleshooting after the unit is completely cooled down.

● The unit does not operate when the power switch is turned ON.

**CHECK :** Is the fuse blown?  
**ACTION :** Investigate why the fuse blew and then replace the fuse.

● The lamp indicates a heater error.

**CHECK :** Is the heater broken?  
**ACTION :** Turn off the power switch. (The heater error will be reset when the power switch is turned off.) Turn on the power switch again, and then the lamp turns on in green and room temperature air (cool air) is discharged. Make sure that the unit is sufficiently cooled (with room temperature), and then press the START/STOP button. If hot air is not discharged and the lamp indicates a heater error again, check the resistance value of the heating element.

**CHECK :** Is air blown into the unit from outside? (The protection system is activated.)  
**ACTION :** Turn off the power switch. (The heater error will be reset when the power switch is turned off.) Turn on the power switch again, and then the lamp turns on in green and room temperature air (cool air) is discharged. Make sure that the unit is sufficiently cooled (with room temperature), and then press the START/STOP button. When the lamp starts flashing in red as in the normal operation status and hot air starts to be discharged, the protection system is reset, enabling operation of the unit.

● The lamp indicates a sensor error.

**CHECK :** Is the sensor broken?  
**ACTION :** Measure the resistance value of the sensor.

● The lamp indicates a overheat error.

**CHECK :** Is the unit too hot?  
**ACTION :** When the unit cools, the error will be cleared automatically and function of the unit will resume. Use the HAKKO FR-830 in an environment and method that does not cause the unit to overheat.

● The lamp indicates a system error.

**ACTION :** A problem has occurred to the control system. Regardless of the operation status, even though this unit is operating or you have just turned on the power switch, immediately stop using the unit, disconnect the power plug, and then contact your HAKKO representative.

Consult your local distributor for further information about other troubles.

## 8. HEATER/SENSOR INSPECTION

### ● Measure the resistance of the heater.

Measure the heater resistance after removing the connector from the heater.  
Heater resistance: 25 to 30 Ω (100 - 120V)  
Heater resistance: 100 to 110 Ω (220 - 240V)  
If the resistance value is different from the above figure, replace the heating element. (For the replacement procedure, see the instruction manual supplied the replacement part.)

### ● Measure the resistance of the sensor.

Measure the sensor resistance after removing the connector from the sensor.  
If the resistance value is ∞, replace the sensor (For the replacement procedure, see the instruction manual supplied the replacement part.)

## 9. OPTIONS

### ● External switch

An optional hand and foot switch are available which can be connected to the unit to START/STOP preheating.

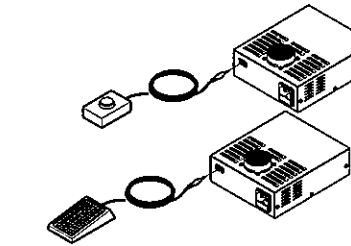

### ● Optional extension pipe

The optional extension pipe can be used to focus the discharged air.

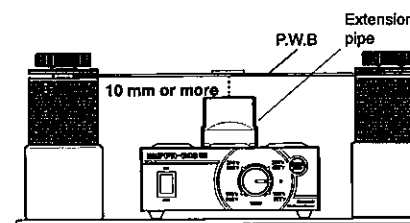

### ● Optional extension lid

If using the FR-802 or FR-803B, use the optional lid and extension pipe to block hot air from being blown into the air outlet when the FR-830 is not in use. Failure to do so may damage the unit.

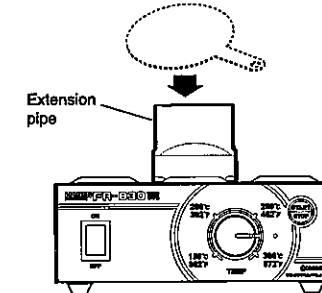

### ⚠ CAUTION

Do not cover the hot air outlet while hot air is blowing from the outlet.

### ■ Connection with HAKKO FM206

HAKKO FM-206 can be connected to HAKKO FR-830 with connecting cable, which permits HAKKO FM-206 to be used along with HAKKO FR-830.

### ⚠ CAUTION

Connect the HAKKO FM-206 and FR-830 by the connecting cable before turning on the power switch.

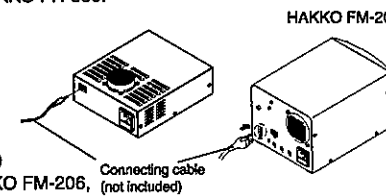

### ● START

When pressing the Hot Air button of HAKKO FM-2029 handpiece with HAKKO FM-2029 connected to HAKKO FM-206, HAKKO FR-830 will work in conjunction with HAKKO FM-206. HAKKO FR-830 and FM-206 will be operated by the setting and mode of each unit.

### NOTE :

When pressing the START/STOP button of the HAKKO FR-830, only HAKKO FR-830 will be activated.

### ● STOP

Press the Hot Air button of the HAKKO FM-2029 handpiece while HAKKO FM-2029 is connected to HAKKO FM-206.

### ⚠ CAUTION

When the HAKKO FM-206 and HAKKO FR-830 are connected, be sure they are both in the same operating state (idle or active) otherwise they units will activate/deactivate opposite of each other. For example, if the FM-206 is idle, but the FR-830 is actively running, pressing the Hot Air button on the HAKKO FM-2029 will activate the FM-206 and will turn off the FR-830.

Please refer to the HAKKO FM-206 or FM-2029 instruction manual for its use.

## 8. HEATER/SENSOR INSPECTION

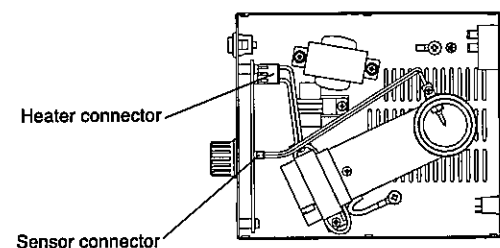

### ⚠ CAUTION

Measure the resistances of the heater and the sensor when their temperatures are at room temperature.

## 10. PARTS LIST

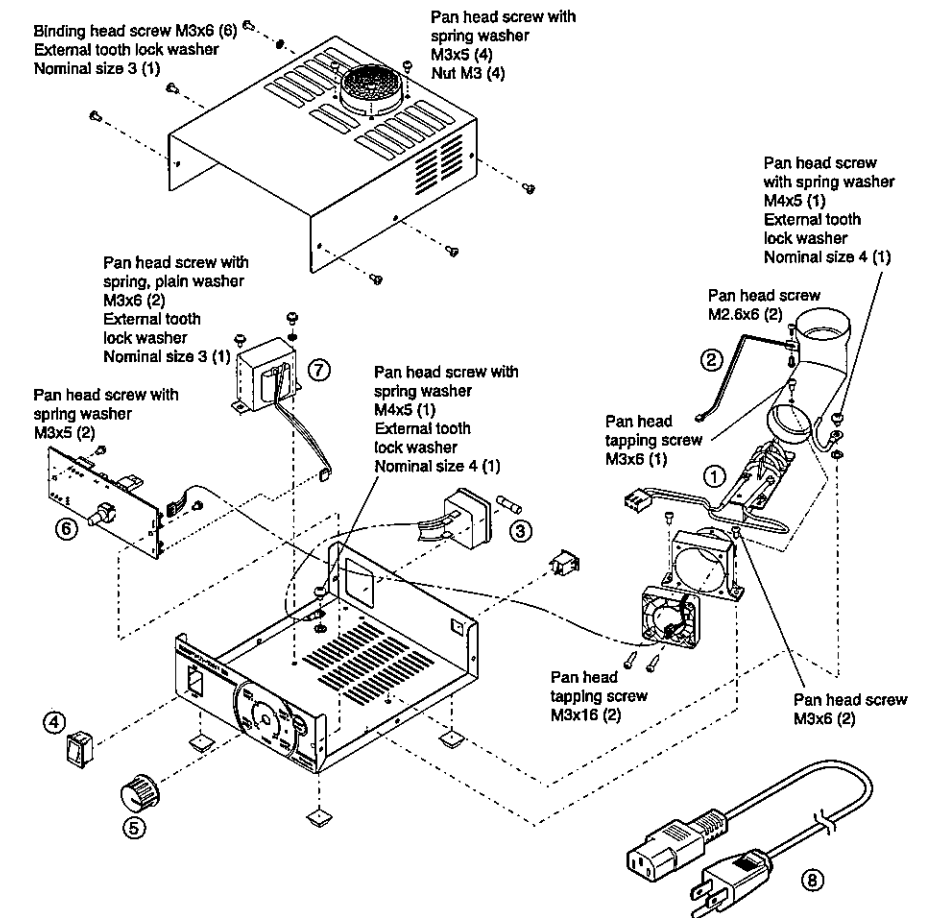

### ● HAKKO FR-830

Item No.	Part No.	Part Name	Specifications
①	A1569	Heater	100 - 120V
	A1570	Heater	220 - 240V
②	A1571	Sensor	
③	B2468	Fuse	125V-5A
④	B1258	Fuse	250V-3.15A
⑤	B1028	Knob	
⑥	B3588	P.W.B.	110 - 120V
	B3589	P.W.B.	220 - 240V
⑦	B3261	Transformer	110 - 120V
	B3262	Transformer	220 - 240V

Item No.	Part No.	Part Name	Specifications
⑧	B2419	Power cord, 3 wired cord & American plug	U.S.A
	B2421	Power cord, 3 wired cord but no plug	220-240V
	B2422	Power cord, 3 wired cord & BS plug	India
	B2424	Power cord, 3 wired cord & European plug	220V KTL, 230V CE
	B2425	Power cord, 3 wired cord & BS plug	230V CE U.K.
	B2426	Power cord, 3 wired cord & Australian plug	
	B2436	Power cord, 3 wired cord & Chinese plug	China
	B3508	Power cord, 3 wired cord & American plug	
	B3550	Power cord, 3 wired cord & SI plug	

### ● Option

Item No.	Part No.	Part Name	Specifications
①	B3263	Extension pipe	With lid
②	B2763	Hand switch	
③	B1649	Foot switch	
④	B3685	Connecting cable	For FM-206

