

# High-Intensity Yellow-Green LED in Plastic T-1<sup>3/4</sup> Package

## OVLGJ0C3B9

- Narrow Beam Angle
- High Luminous Intensity
- Water Clear Plastic Package
- Yellow-Green (575nm)

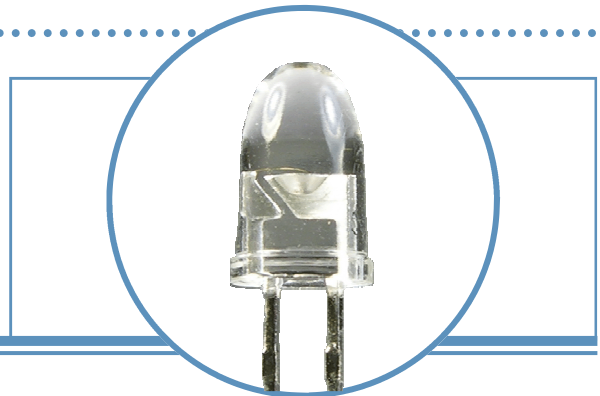

The OVLGJ0C3B9 is a high intensity AlInGaP LED mounted in a clear plastic T-1<sup>3/4</sup> package. The device incorporates an integral molded lens that enables a narrow beam angle and provides an even emission pattern. Designed to produce light over a wide range of drive currents, this LED is useful in applications requiring higher on-axis brightness than that achievable with standard lamps.

### Applications

- Indoor/Outdoor Applications
- Message Boards
- Store Front Signage
- Indicators

Part Number	Material	Emitted Color	Intensity Typ. mcd	Lens Color
OVLGJ0C3B9	AlInGaP	Yellow-Green	2300	Water Clear

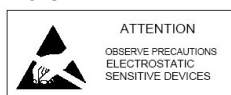
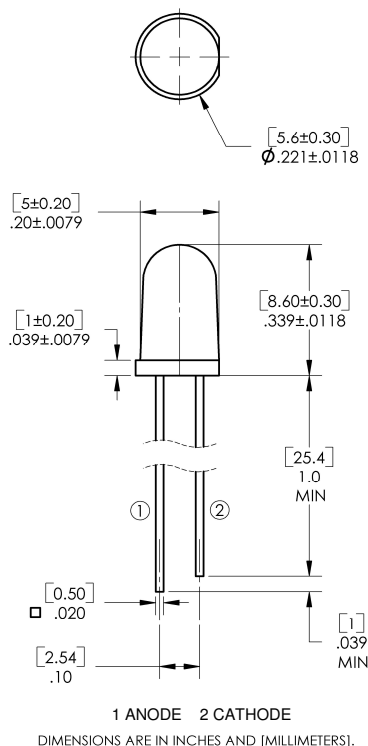

OPTEK reserves the right to make changes at any time in order to improve design and to supply the best product possible.

# T-1 $\frac{3}{4}$ High-Intensity Yellow-Green LED

## OVLGJ0C3B9



### Absolute Maximum Ratings

T<sub>A</sub> = 25°C unless otherwise noted

Storage Temperature Range	-40 ~ +100 °C
Operating Temperature Range	-40 ~ +85 °C
Lead Soldering Temperature (3mm from the base of the epoxy bulb) <sup>1</sup>	260 °C
Reverse Voltage	5 V
Continuous Forward Current <sup>2</sup>	25 mA
Peak Forward Current (10% Duty Cycle, 1KHz)	180 mA
Power Dissipation	100 mW

Note:

1. Solder time less than 5 seconds at temperature extreme.

### Electrical Characteristics

T<sub>A</sub> = 25°C unless otherwise noted

SYMBOL	PARAMETER	MIN	TYP	MAX	UNITS	CONDITIONS
I <sub>v</sub>	Luminous Intensity	----	138	----	mcd	I <sub>F</sub> = 2mA
		1500	2300	----		I <sub>F</sub> = 20mA
V <sub>F</sub>	Forward Voltage	----	2.0	2.4	V	I <sub>F</sub> = 20mA
I <sub>R</sub>	Reverse Current	----	----	10	μA	V <sub>R</sub> = 5V
λ <sub>P</sub>	Peak Wavelength	----	575	----	nm	I <sub>F</sub> = 20mA
λ <sub>D</sub>	Dominant Wavelength	----	573	----	nm	I <sub>F</sub> = 20mA
Δλ	Spectral Bandwidth	----	20	----	nm	I <sub>F</sub> = 20mA
2Θ $\frac{1}{2}$ H-H	50% Power Angle	----	6	----	deg	I <sub>F</sub> = 20mA

Typical Electro-Optical Characteristics Curves

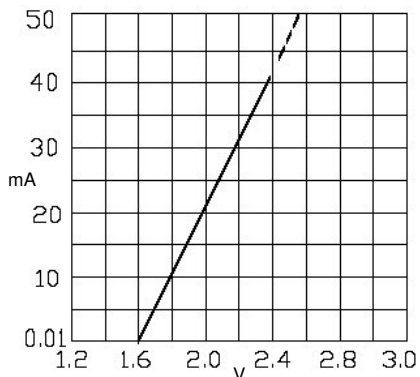

Forward Current vs. Forward Voltage

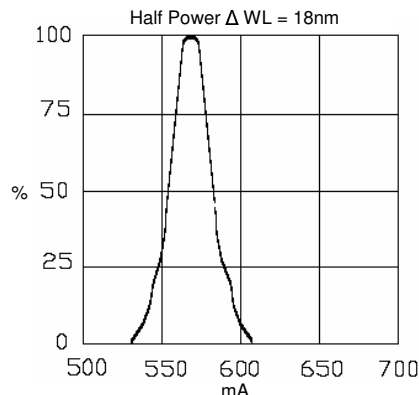

Relative Luminous Intensity vs. Wavelength

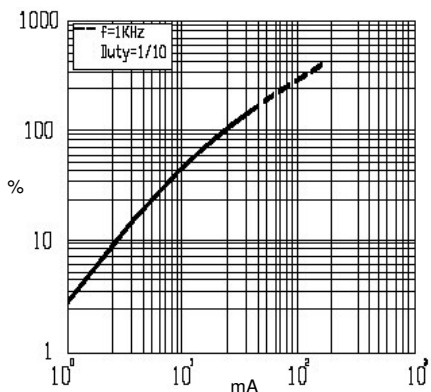

Relative Luminous Intensity vs. Forward Current

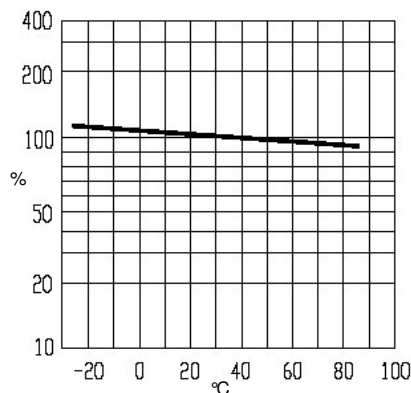

Relative Luminous Intensity vs. Ambient Temperature

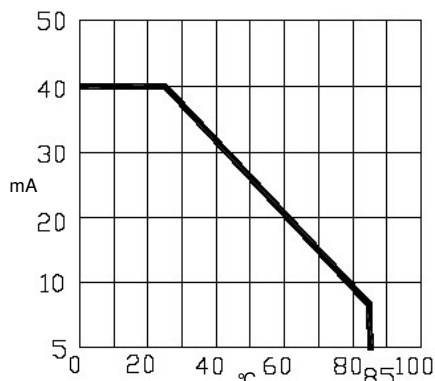

Forward Current vs. Ambient Temperature

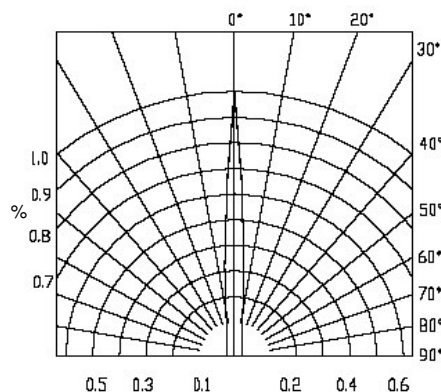

Relative Intensity vs. Radiation Angle

