

DETAILS

Product Number	CA12426_TINA3-W
Family	Tina
Type	Assembly
Color	white
Diameter	16,1 mm
Height	6,9 mm
Style	round
Optic Material	PMMA
Holder Material	
Fastening	tape, pin
Status	production ready
ROHS Compliant	Yes
Date Updated	11/11/2016



OPTICAL PROPERTIES

LED	Viewing Angle	Light Beam	Efficiency	cd/lm	Connector
XP-G	42 deg	Wide	90 %	1.700	-
XP-G2	42 deg	Wide	91 %	1.600	-
XT-E	41 deg	Wide	88 %	1.800	-
XP-E2	43 deg	Wide	90 %	1.800	-
XP-L HI	43 deg	Wide	93 %	1.600	-
XHP35 HI	46 deg	Wide	93 %	1.500	-
LUXEON A	43 deg	Wide	89 %	1.500	-
LUXEON T	45 deg	Wide	89 %	1.500	-
LUXEON H50-2	sim: 48	Wide	sim: 89 %	sim: 1.500	-
LUXEON TX	47 deg	Wide	89 %	1.200	-
NVSxx19A	43 deg	Wide	86 %	1.500	-
NVSxx19B/NVSxx19C	46 deg	Wide	92 %	1.400	-
Oslon Square EC	41 deg	Wide	88 %	1.700	-
LH351Z	49 deg	Wide	89 %	1.300	-
LH351B	46 deg	Wide	89 %	1.400	-

Relative intensity of CA12426_TINA3-W_(XPH35_HI)

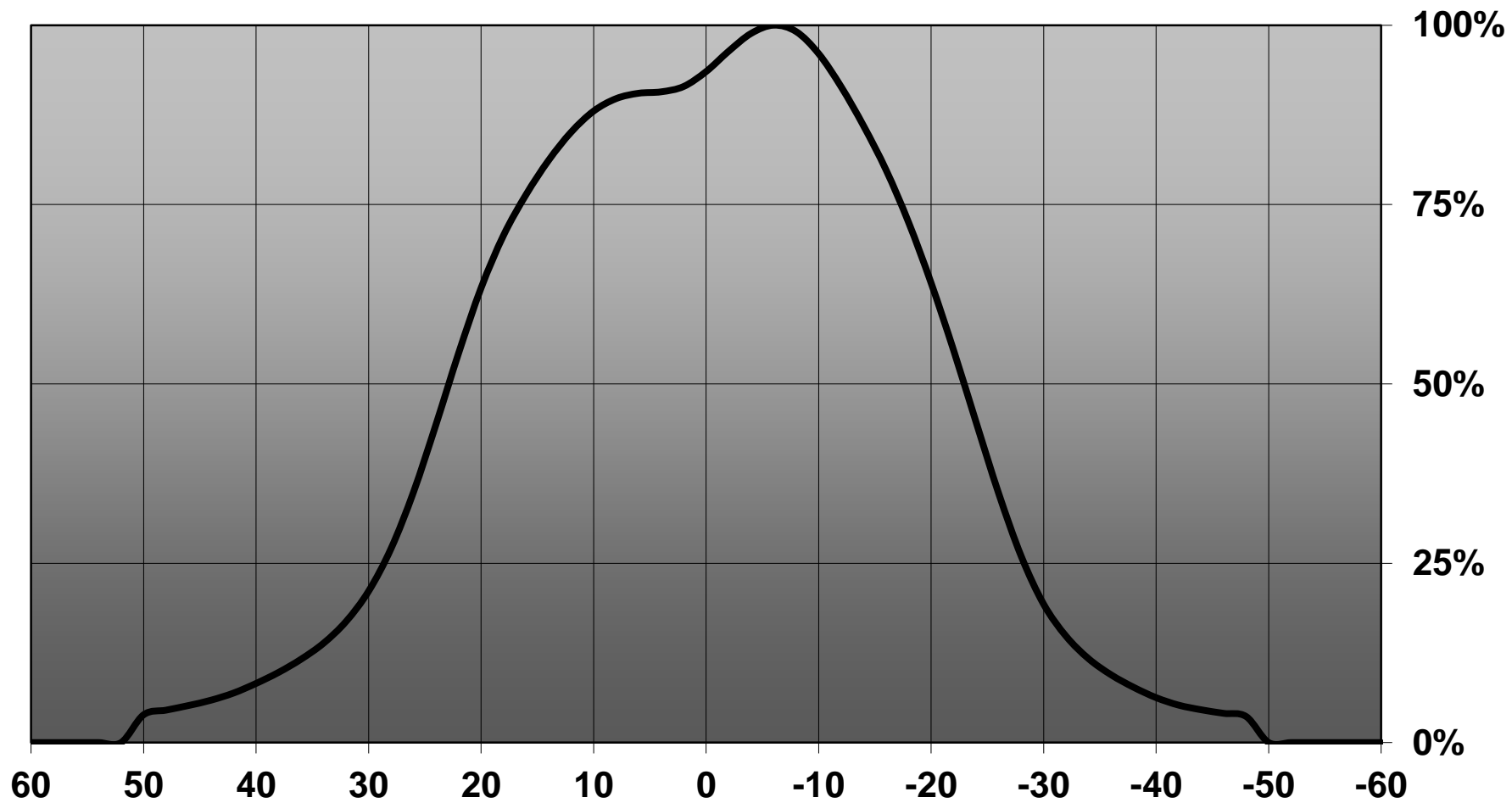

D

C

B

A

4

4

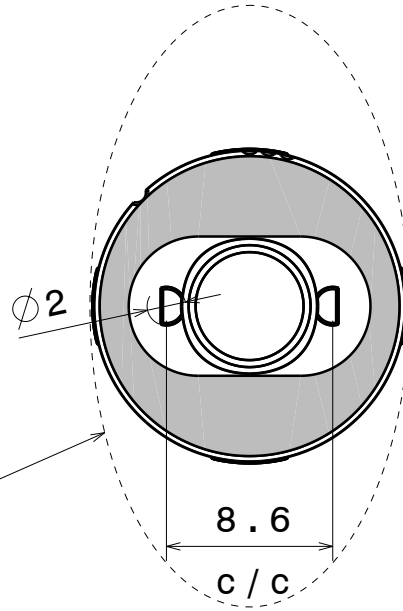
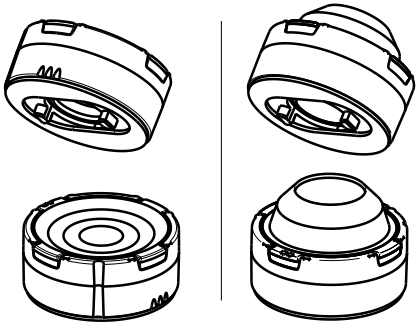

Oval beam direction

8.6

c / c

3

3

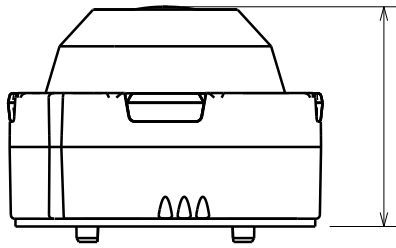

11.4

Spot version height

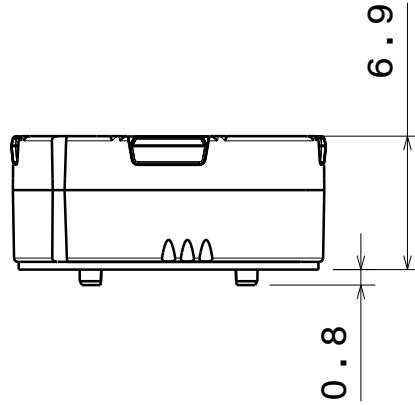

6.9

0.8

2

2

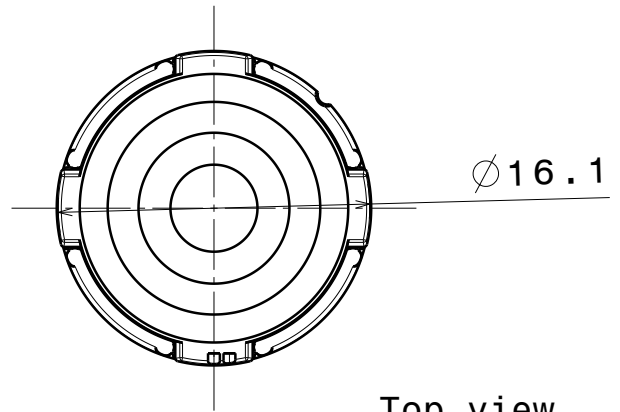

Ø 16.1

Top view

Tolerances if not otherwise shown
 According to DIN ISO 2768-1
 Linear measures:
 Up to 30mm class M, otherwise class C.
 According to DIN ISO 2768-2
 Form and position: class L



Ledil Oy
 Salorankatu 10
 FIN 24240 SALO
 Finland

THIRD ANGLE PROJECTION:

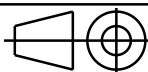

DRAWING TITLE

TINA3 Datasheet

This drawing is the property
 of LEDiL Oy. It may not be
 reproduced, copied or
 communicated without a written
 agreement with LEDiL Oy."

SIZE

A4

PART NUMBER

-

SCALE

4:3

WEIGHT

-

SHEET

1 / 1

D

A

1

1

Luminaire: Ledil Oy CA12426_TINA3-W (Cree XP-G 68lm @ 250mA) Efficiency=90%
Lamps: 1 x Cree XP-G 68lm @ 250mA

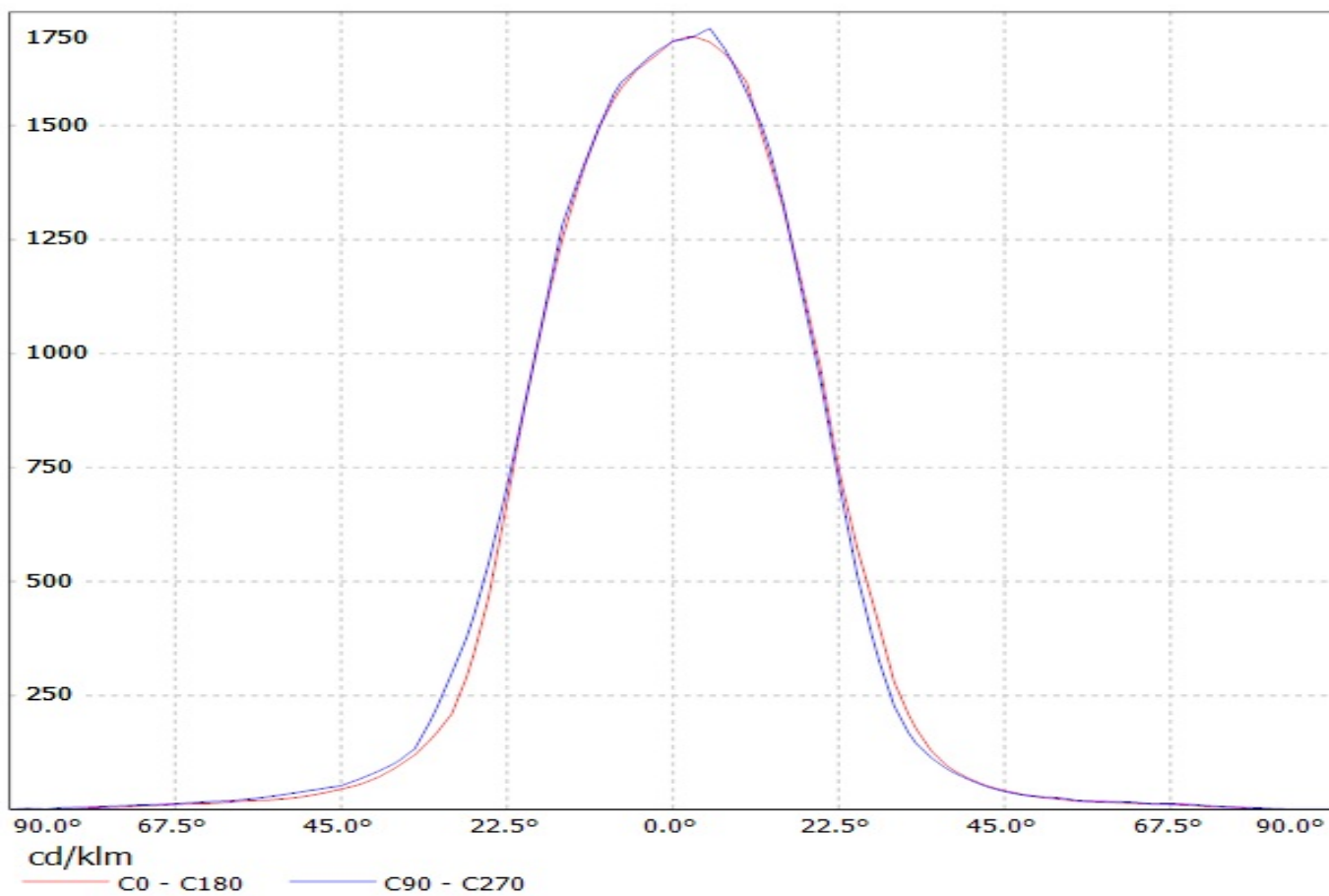

Luminaire: Ledil Oy CA12426_TINA3-W (Cree XP-G2 98.8lm @ 250mA) Efficiency=91%
Lamps: 1 x Cree XP-G2 98.8lm @ 250mA

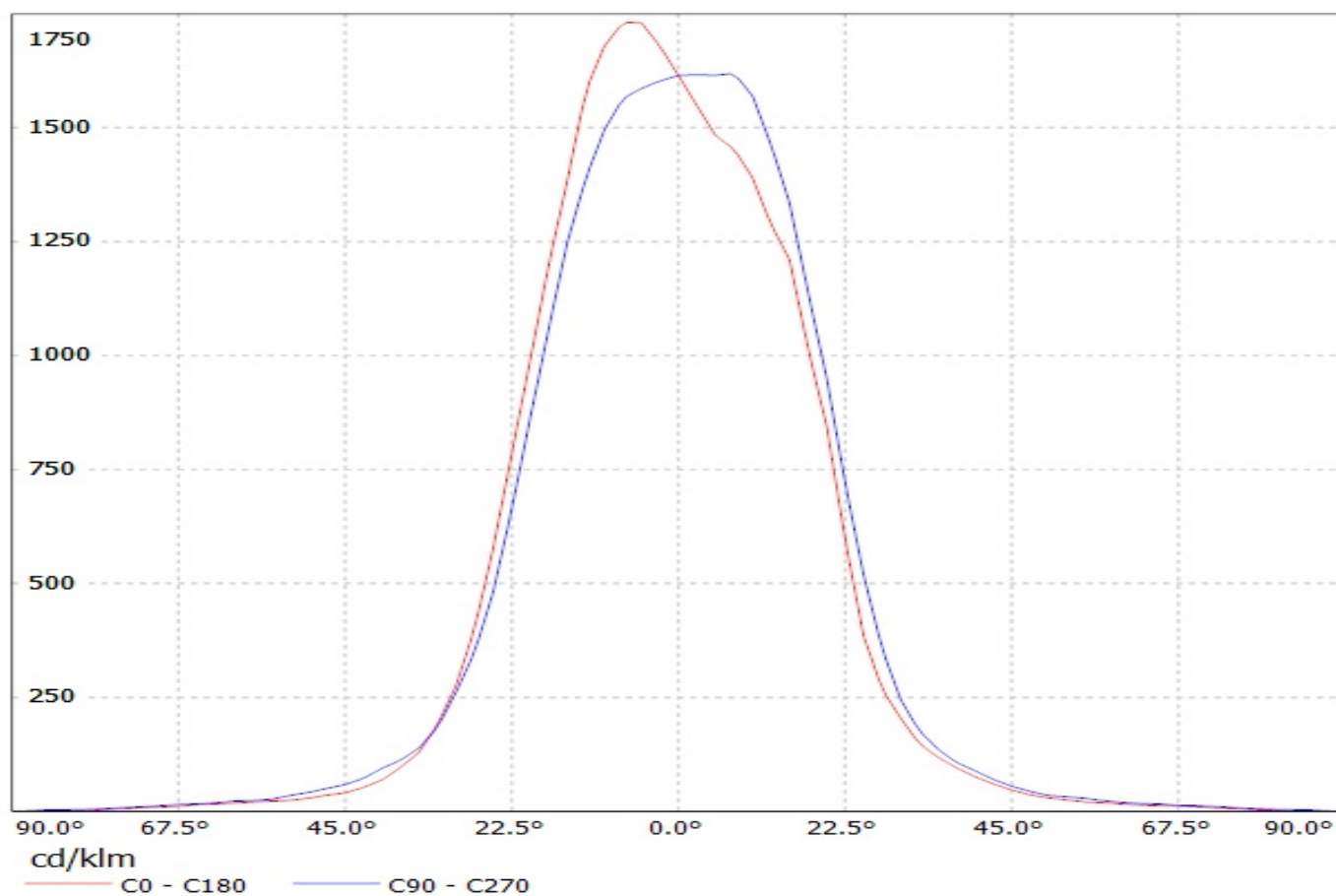

Luminaire: Ledil Oy CA12426_TINA3-W (Cree XT-E 98lm @ 250mA) Efficiency=88%
Lamps: 1 x Cree XT-E 98lm @ 250mA

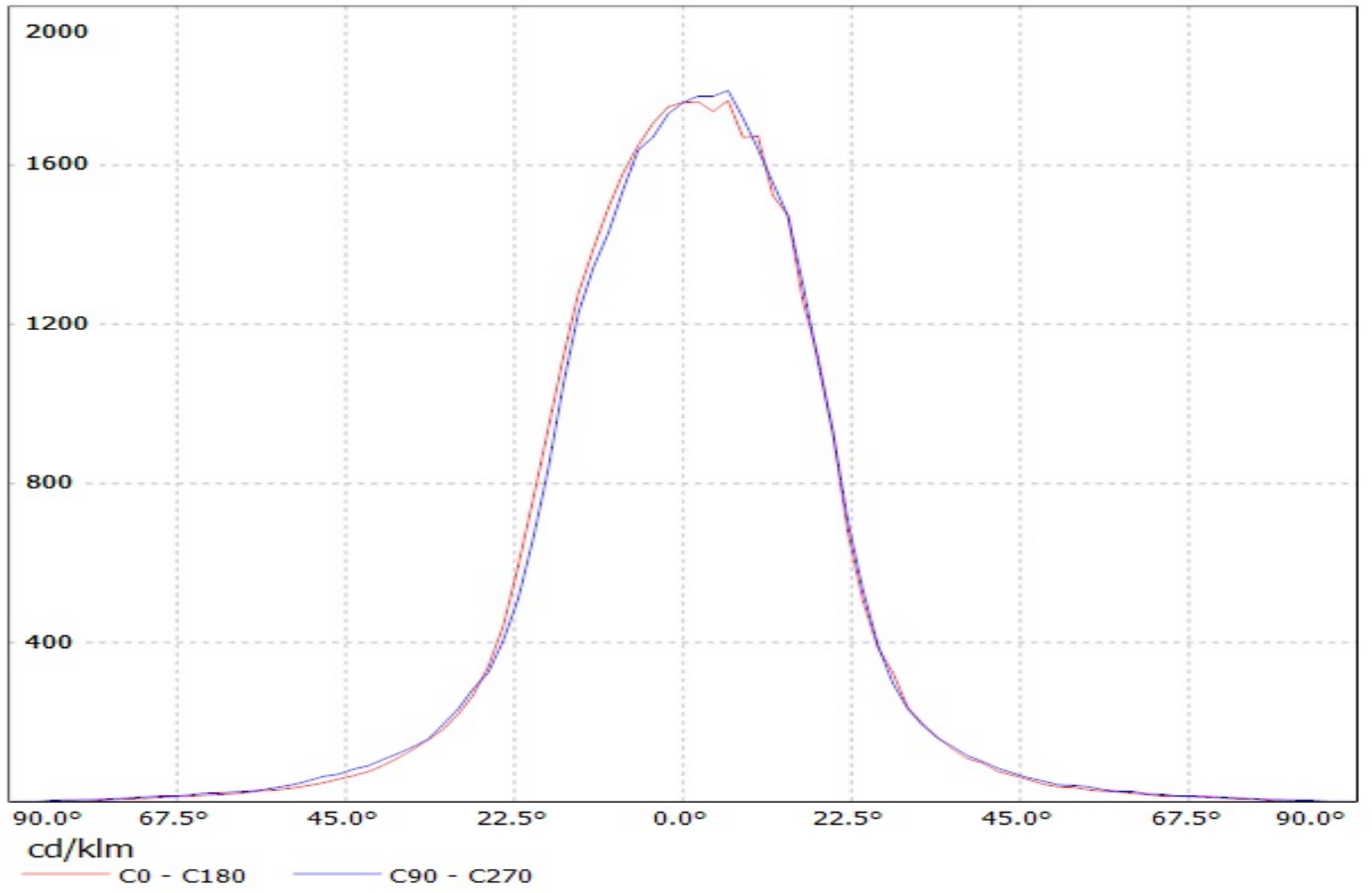

Luminaire: Ledil Oy CA12426_TINA3-W_(XP-E2) Efficiency=90%
Lamps: 1 x Cree XP-E2 93lm @ 250mA CCT=5600K P=0.8W I=250mA

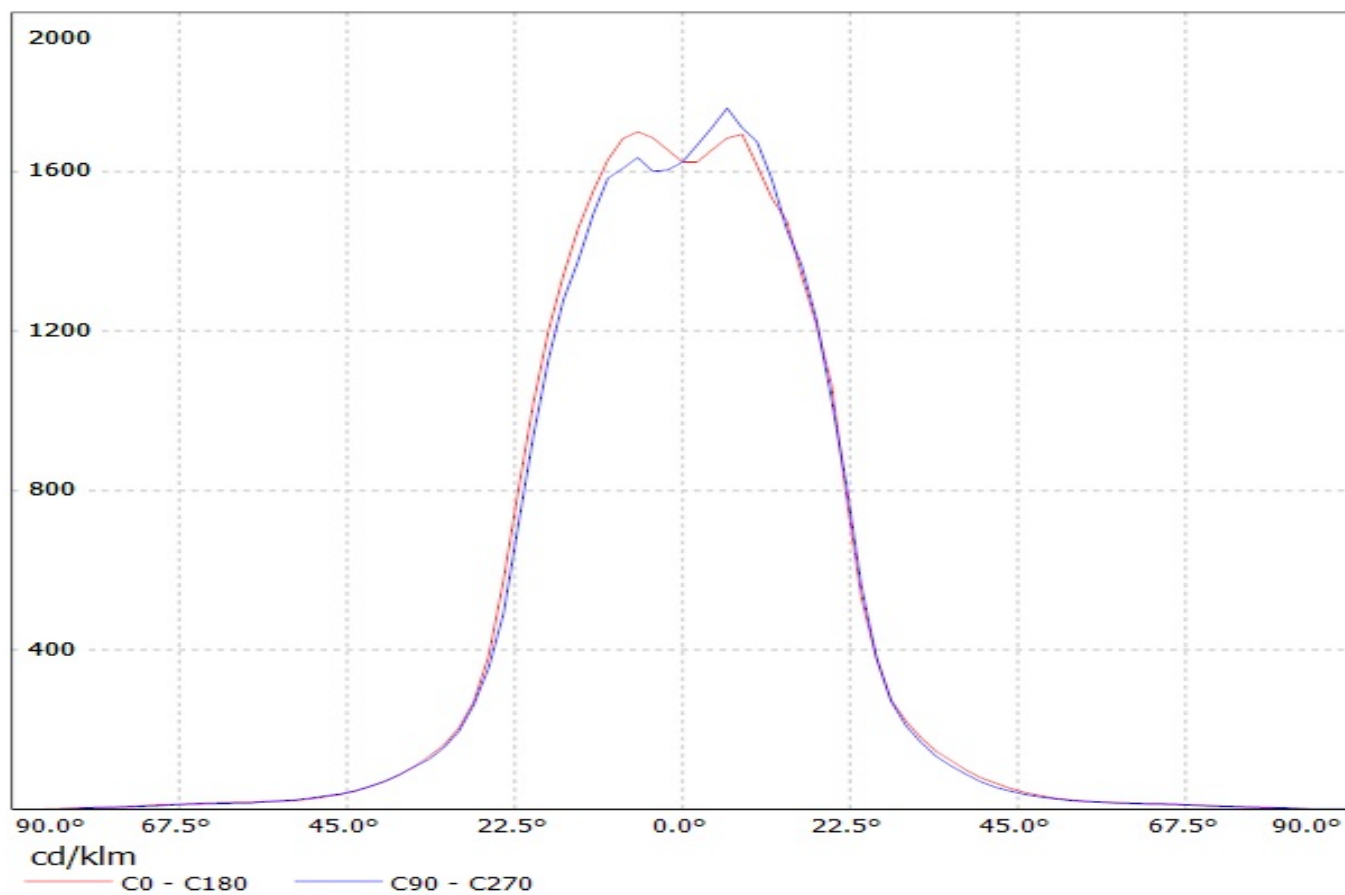

Luminaire: LEDiL Oy CA12426_TINA3-W_(XP-L_HI)
Lamps: 1 x Cree_XP-L_HI_113.703lm@250mA_P=0.743328W_I=0.2499A

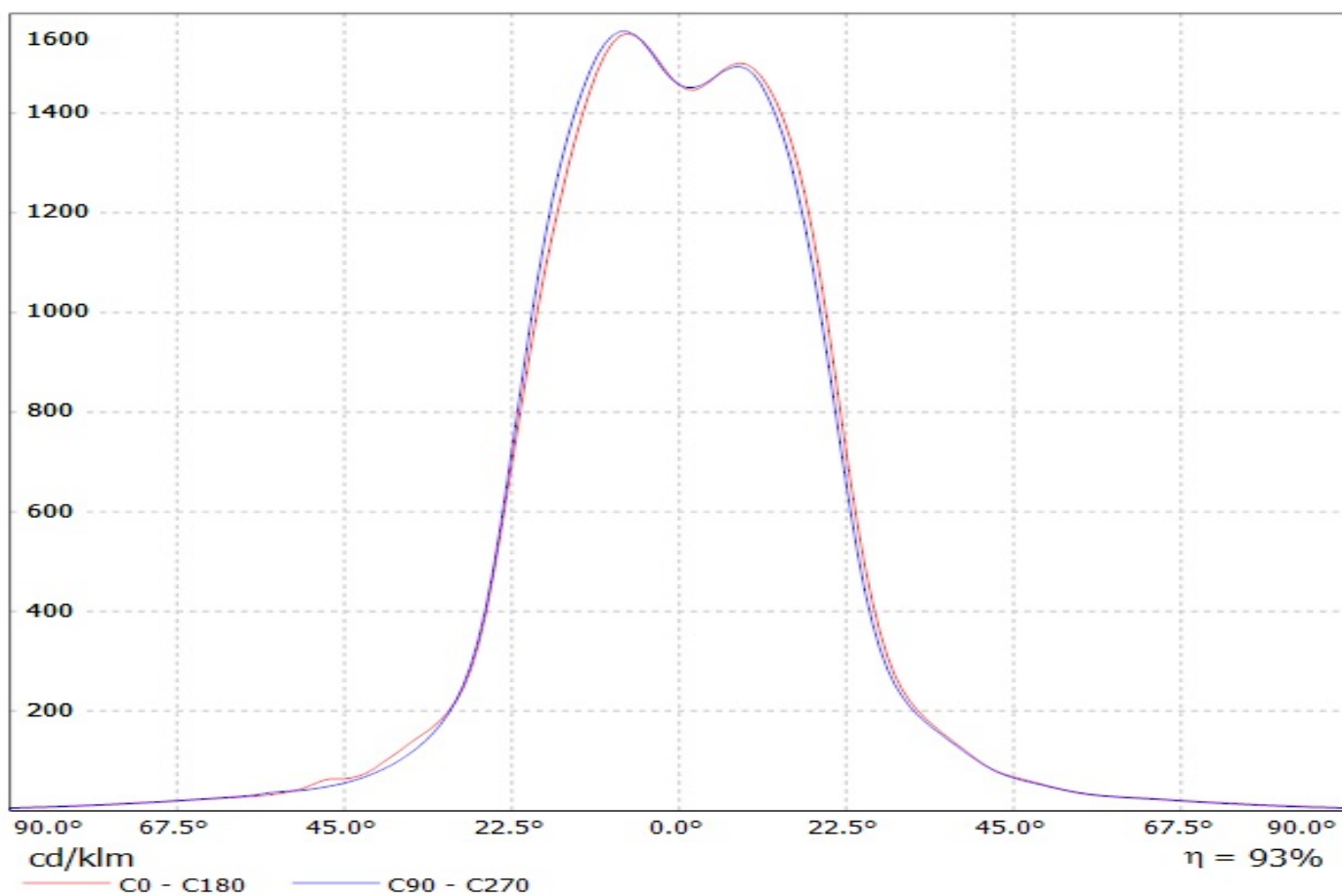

Luminaire: Ledil Oy CA12426_TINA3-W_(XHP35_HI)_SIMULATED
Lamps: 1 x Cree XHP35 HI

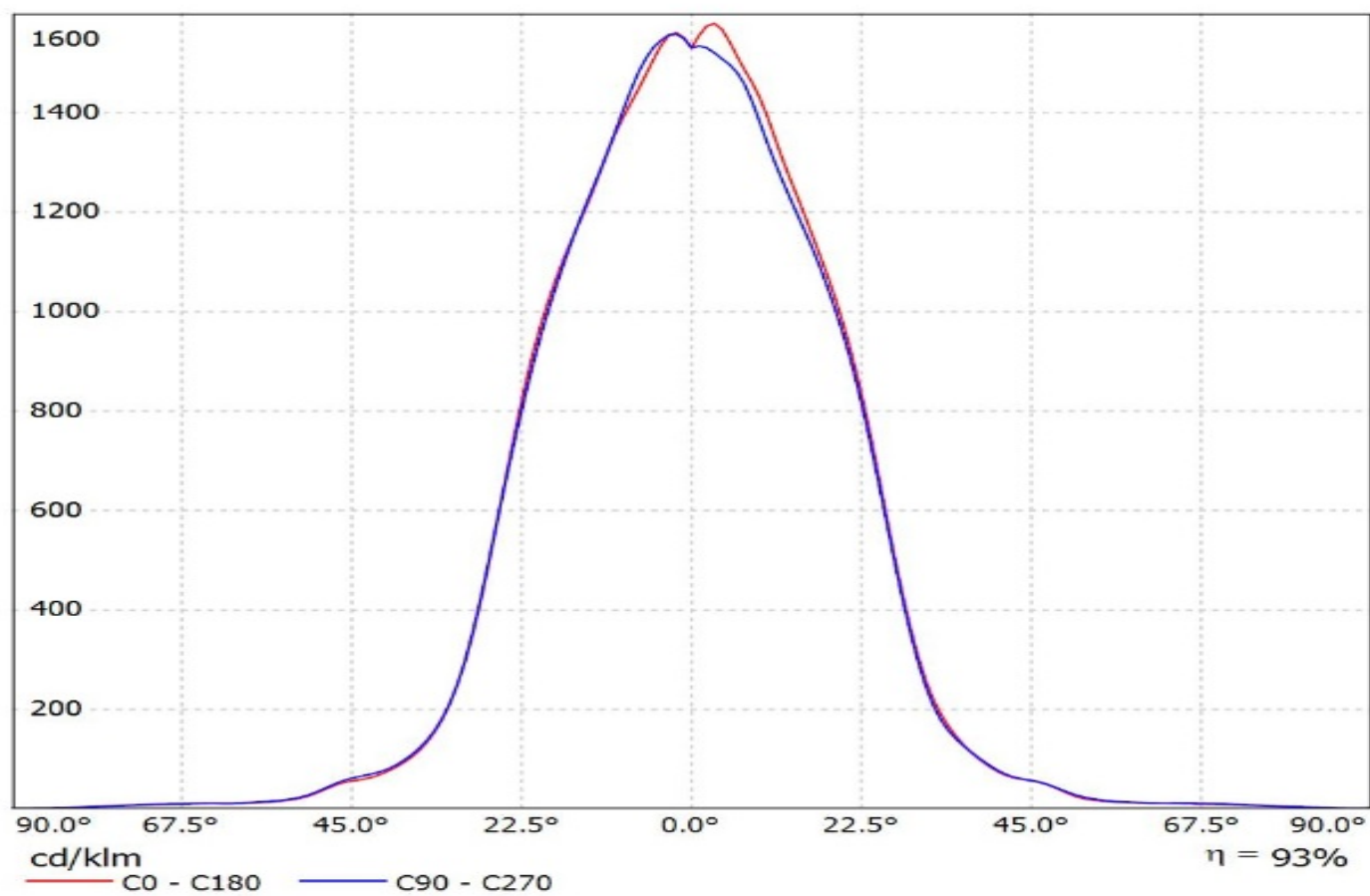

Luminaire: Ledil Oy CA12426_TINA3-W (Luxeon A 64lm @ 250mA) Efficiency=89%
Lamps: 1 x Luxeon A 64lm @ 250mA

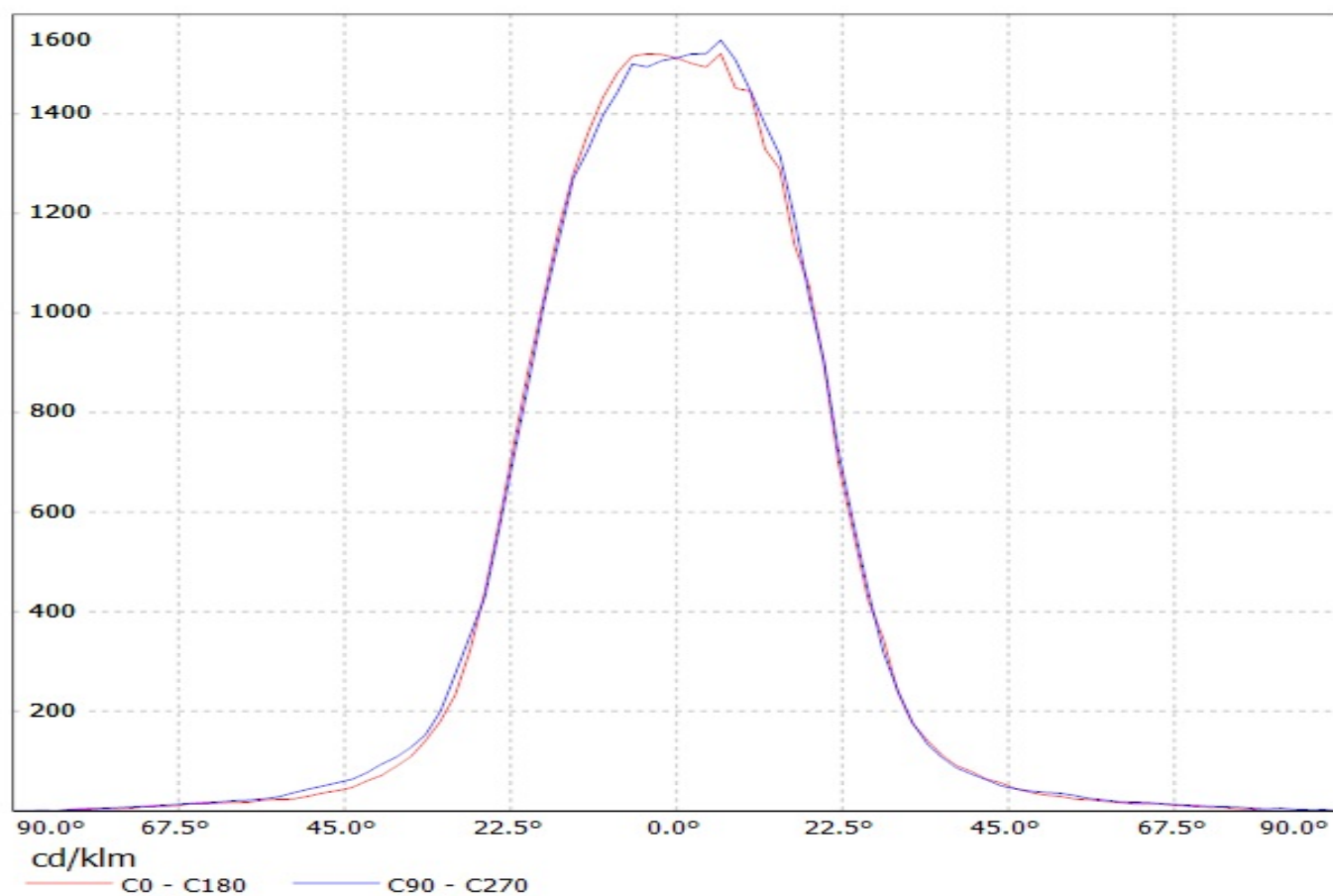

LEDiL Oy CA12426_TINA3-W_(LUXEON_T)_2 Eff.89.4% / LDC (Linear)

Luminaire: LEDiL Oy CA12426_TINA3-W_(LUXEON_T)_2 Eff.89.4%
Lamps: 1 x LUXEON T (74lm@250mA)

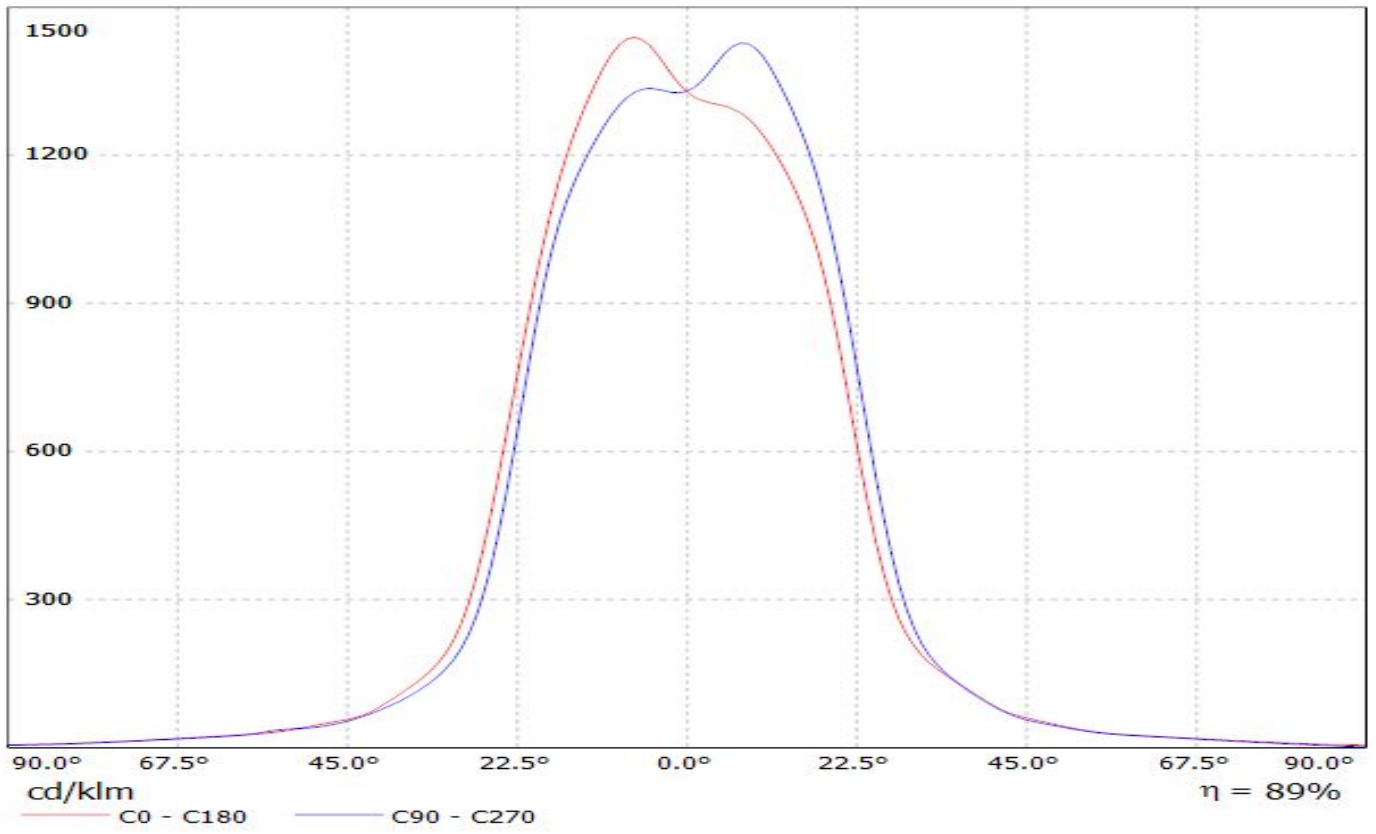

Luminaire: Ledil Oy CA12426_TINA3-W_(Luxeon_TX) Efficiency=89%
Lamps: 1 x Luxeon TX (L1T2-3585) 108lm @ 250mA CCT=3521K P=0.73W I=250mA

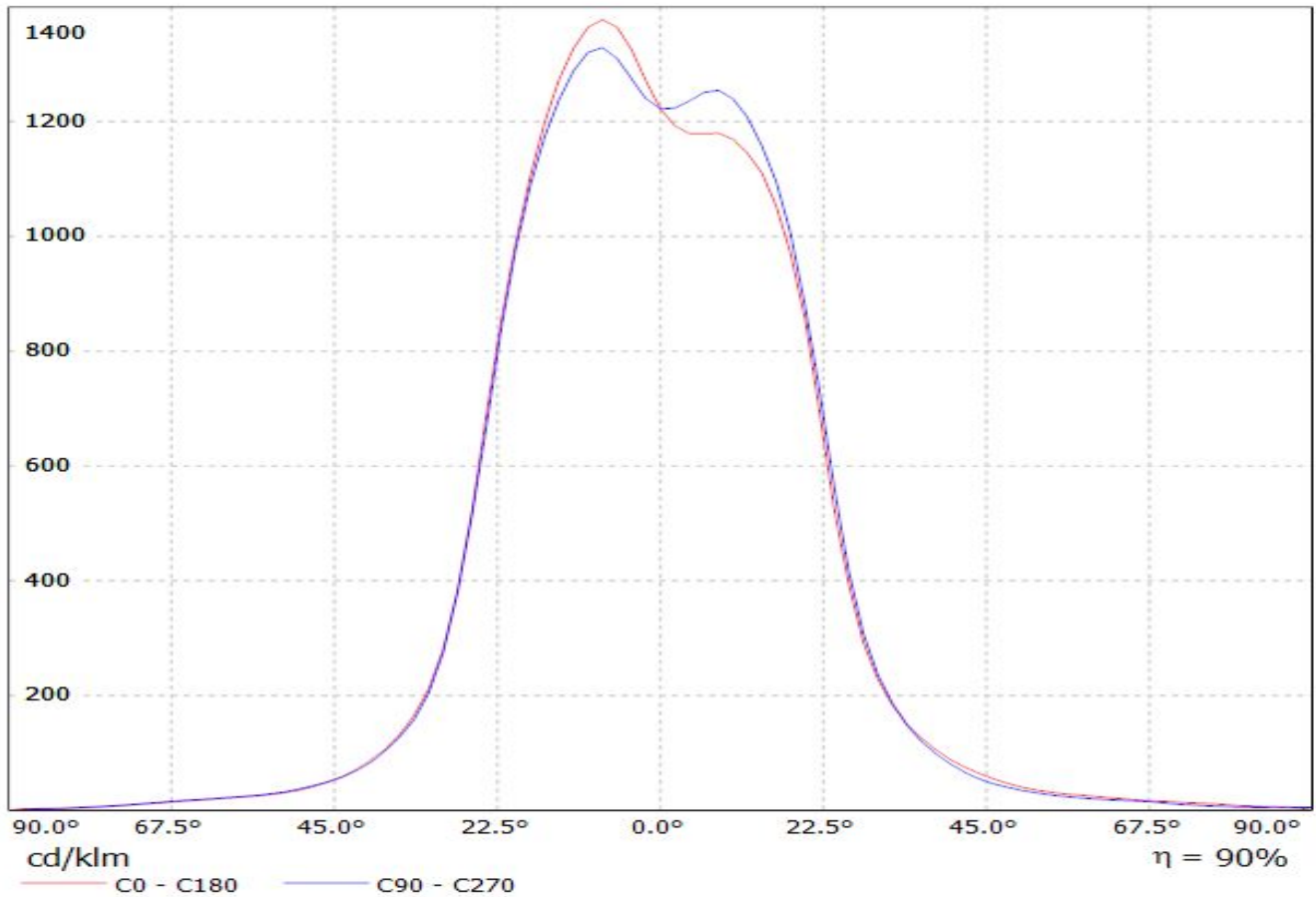

Luminaire: Ledil Oy CA12426_TINA3-W (Nichia NVS19 92lm @ 250mA) Efficiency=86%
Lamps: 1 x Nichia NVS19 92lm @ 250mA

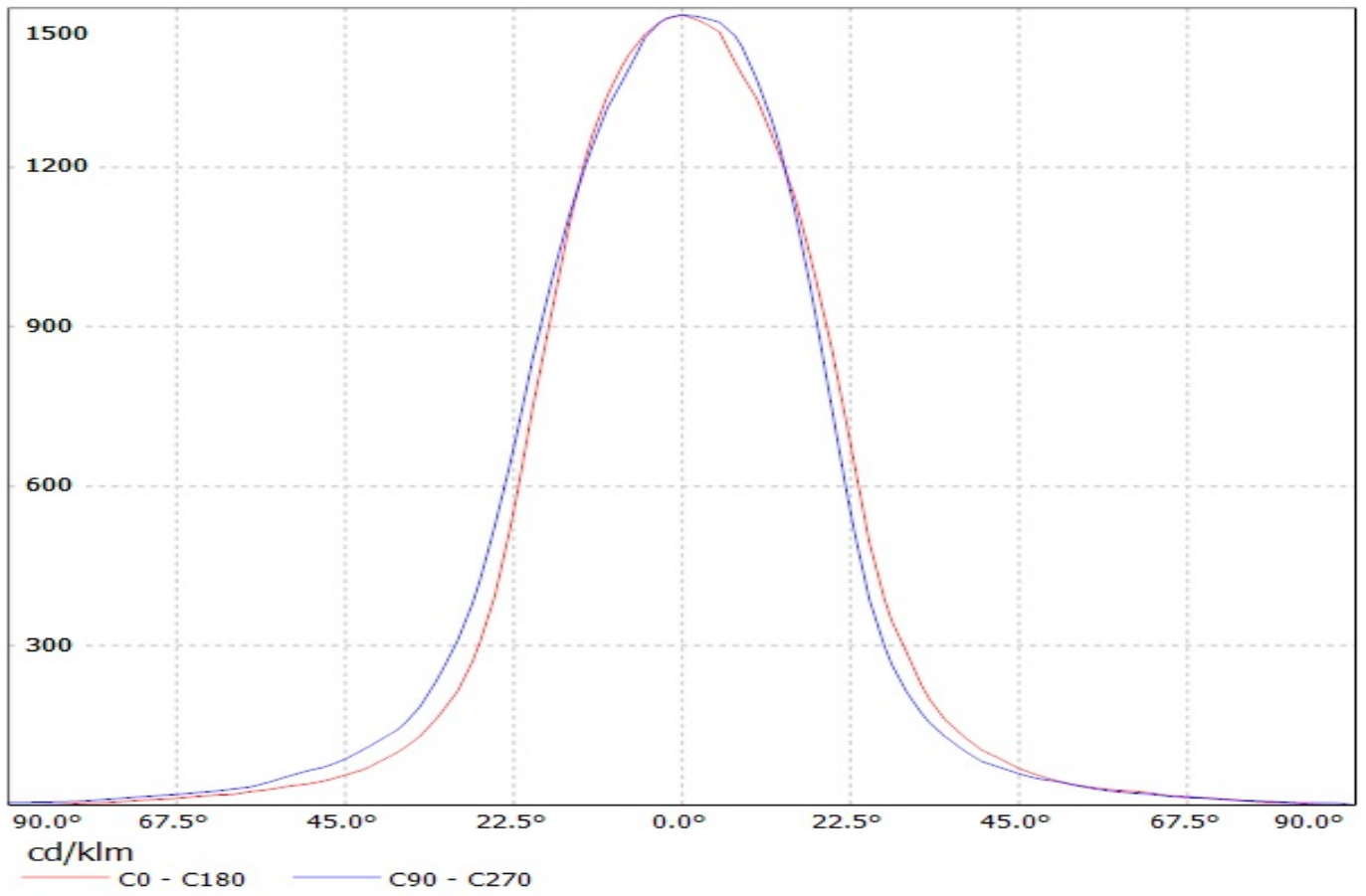

Luminaire: LEDiL Oy CA12426_TINA3-W_(NVSL219CE)

Lamps: 2 x Nichia_NVSL219CE_101.227lm@250mA_P=0.713404W_I=0.25A

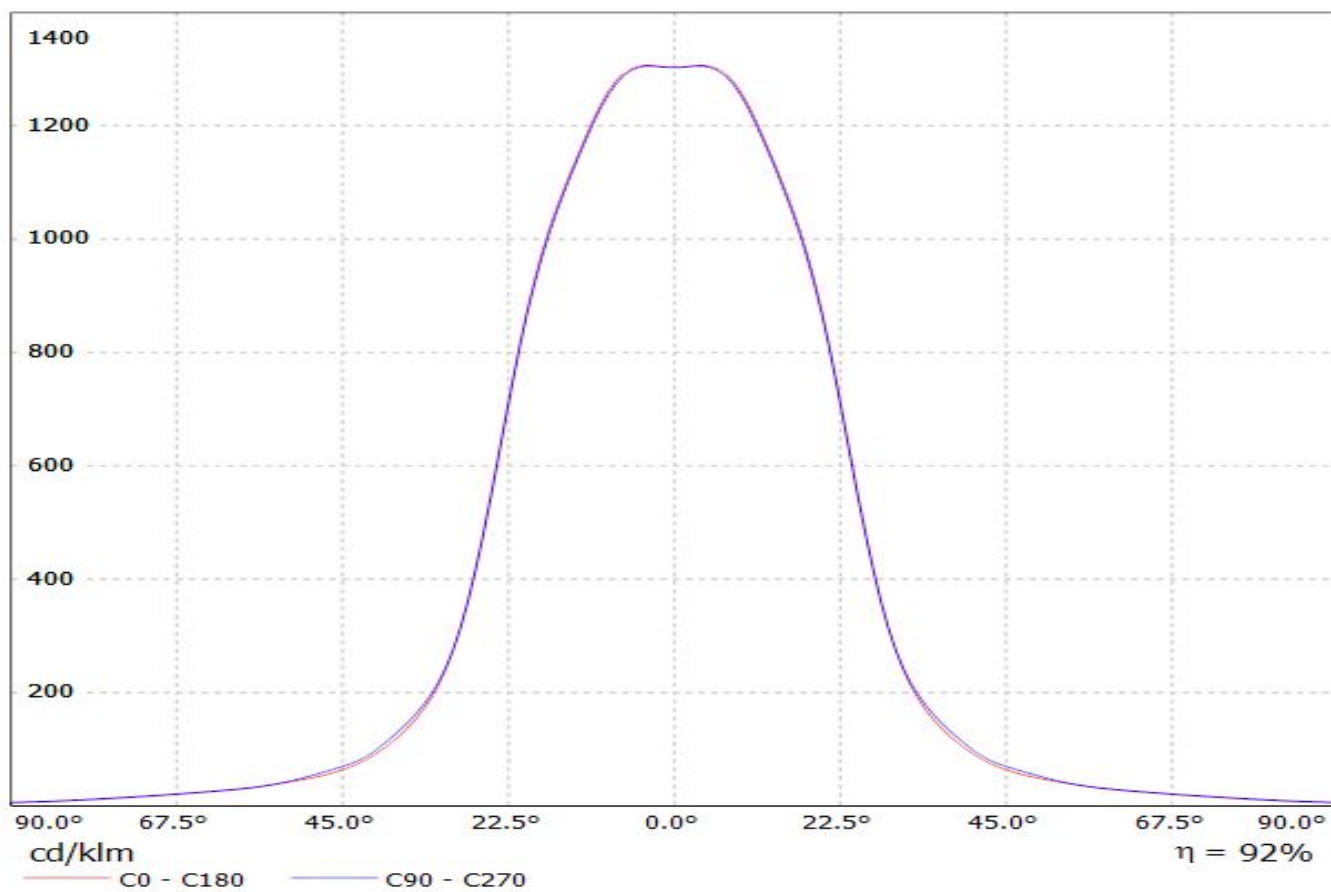

Luminaire: Ledil Oy CA12426_TINA3-W (Osram Square EC 66lm @ 250mA) Efficiency=88%
Lamps: 1 x Osram Square EC 66lm @ 250mA

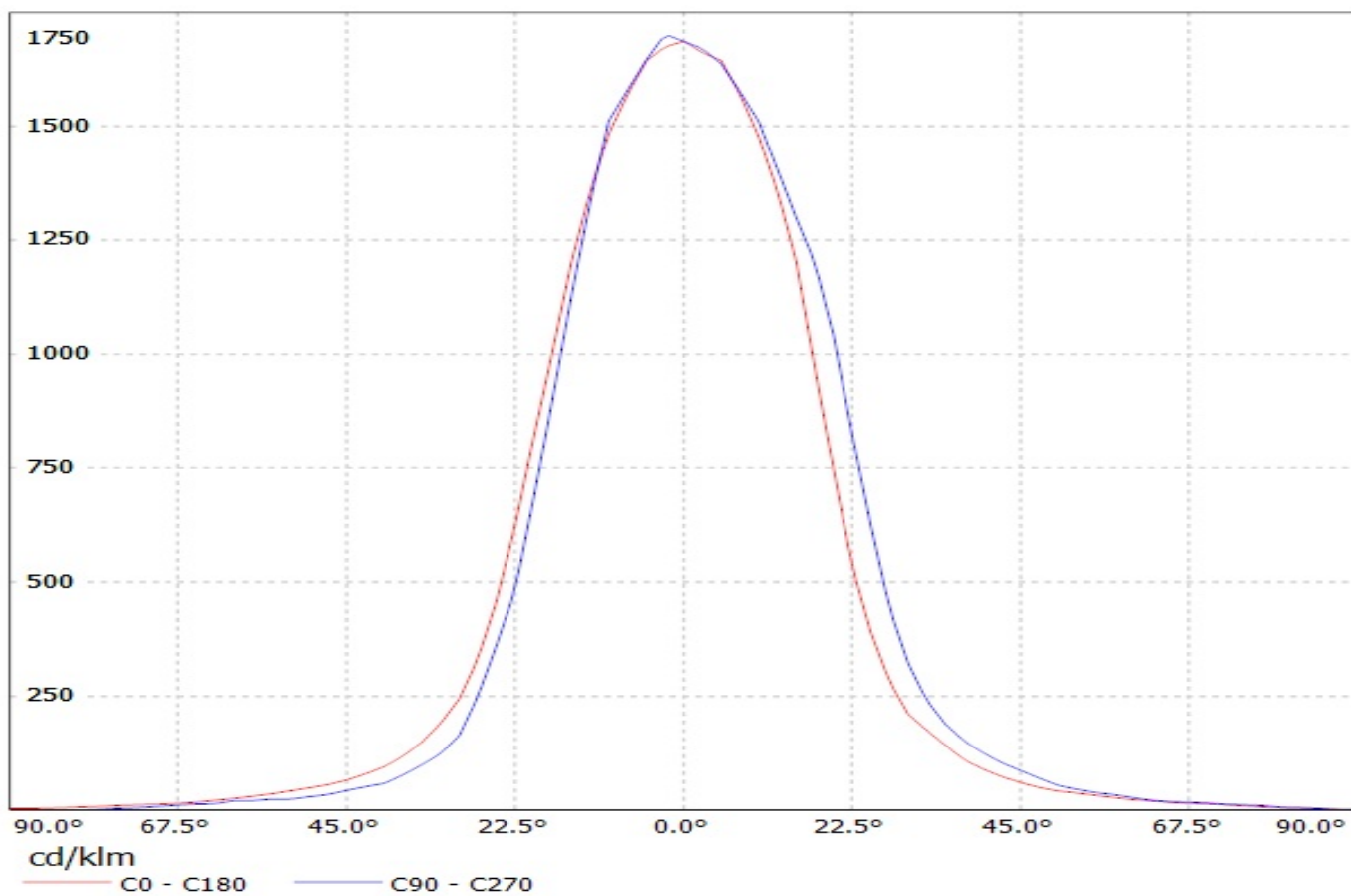

Luminaire: Ledil Oy CA12426_TINA3-W_(LH351Z) Efficiency=89%
Lamps: 1 x Samsung LH351Z (90.14lm @ 250mA) CCT=6500K P=0.7W I=250mA

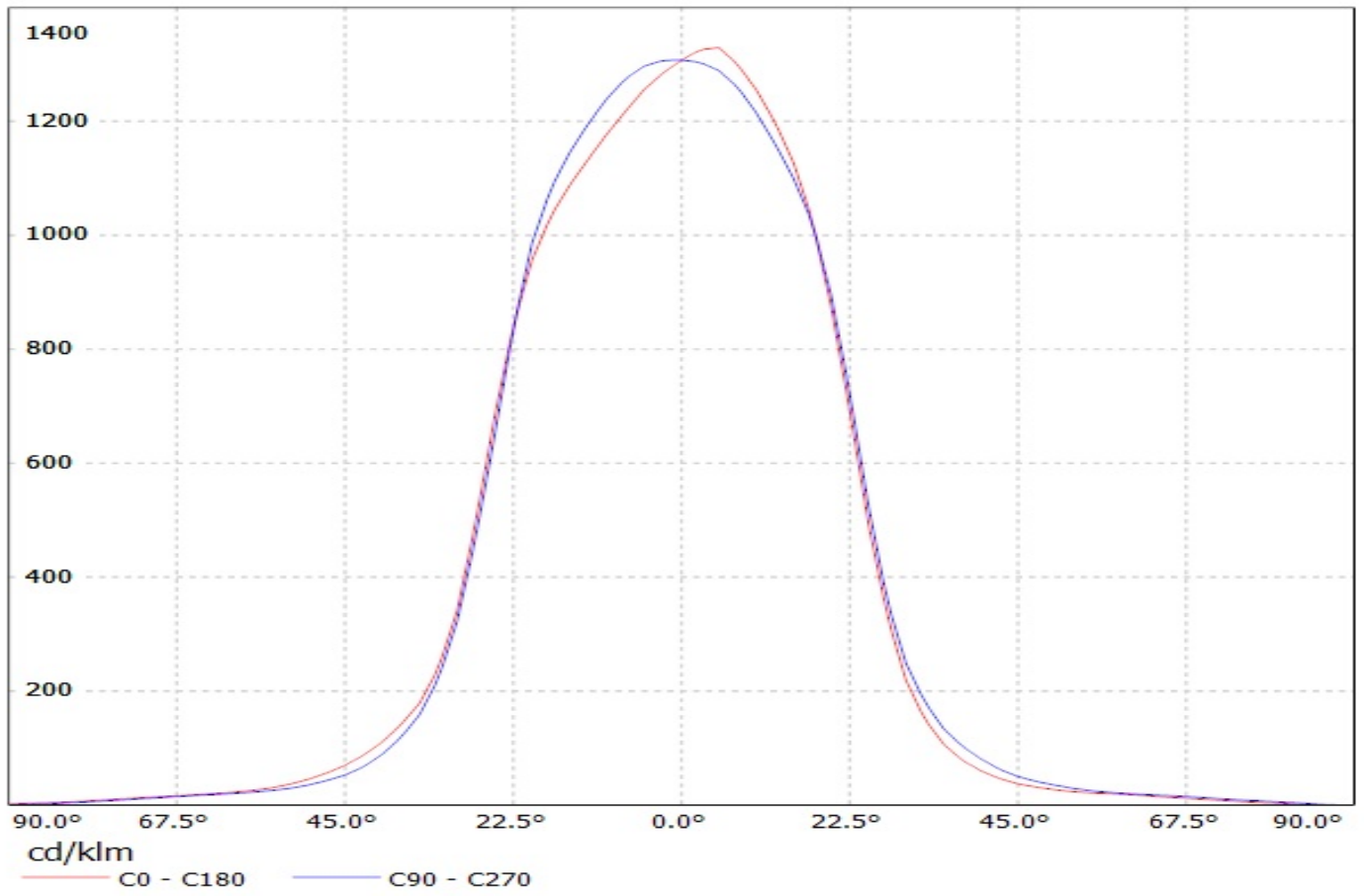

Luminaire: LEDiL Oy CA12426_TINA3-W_(LH351B)

Lamps: 1 x SAMSUNG_LH351B_107.366lm@250mA_P=2.9308W_I=249.9mA

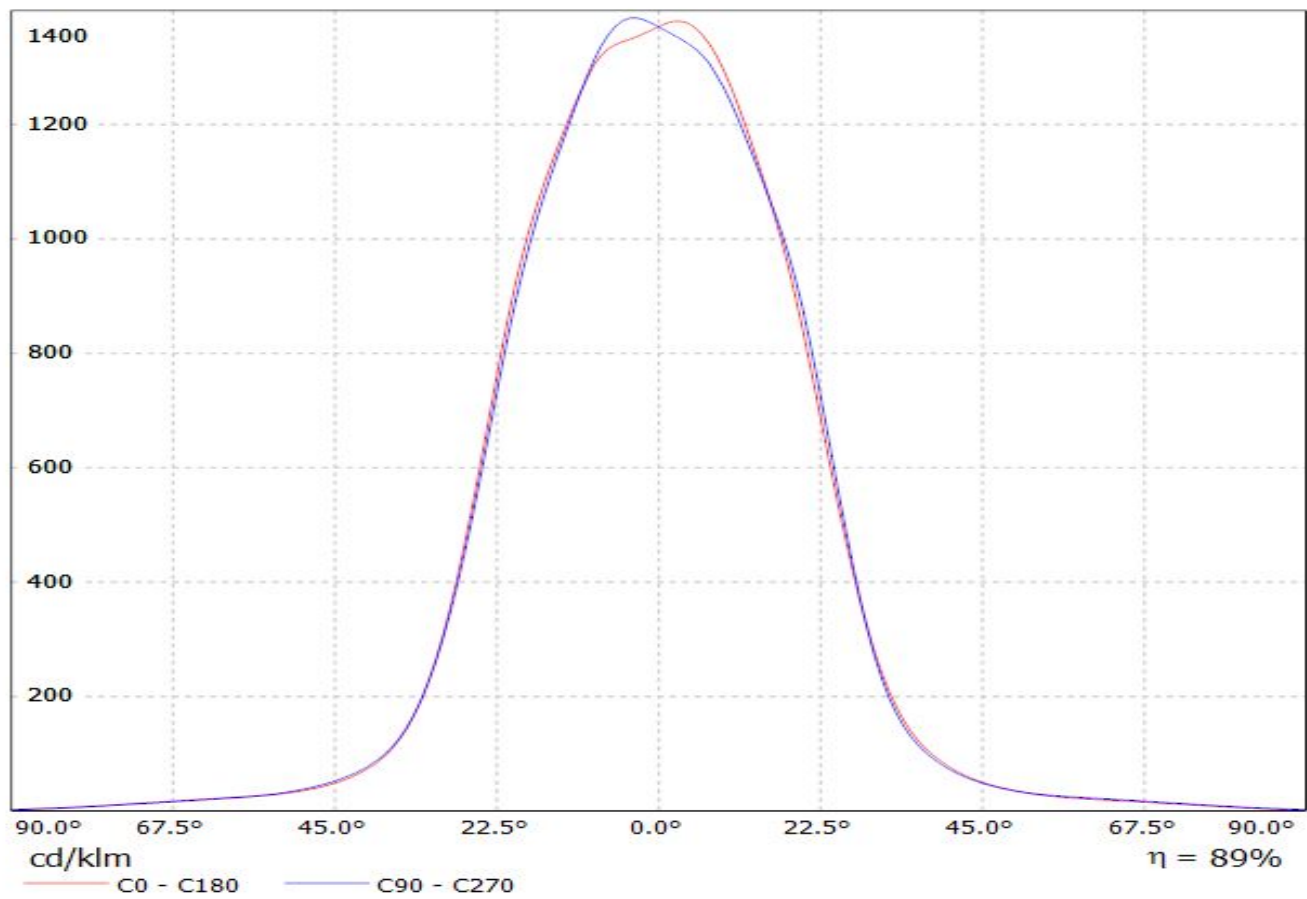

Luminaire: Ledil Oy CA12426_TINA3-W (Cree XP-G 68lm @ 250mA) Efficiency=90%
Lamps: 1 x Cree XP-G 68lm @ 250mA

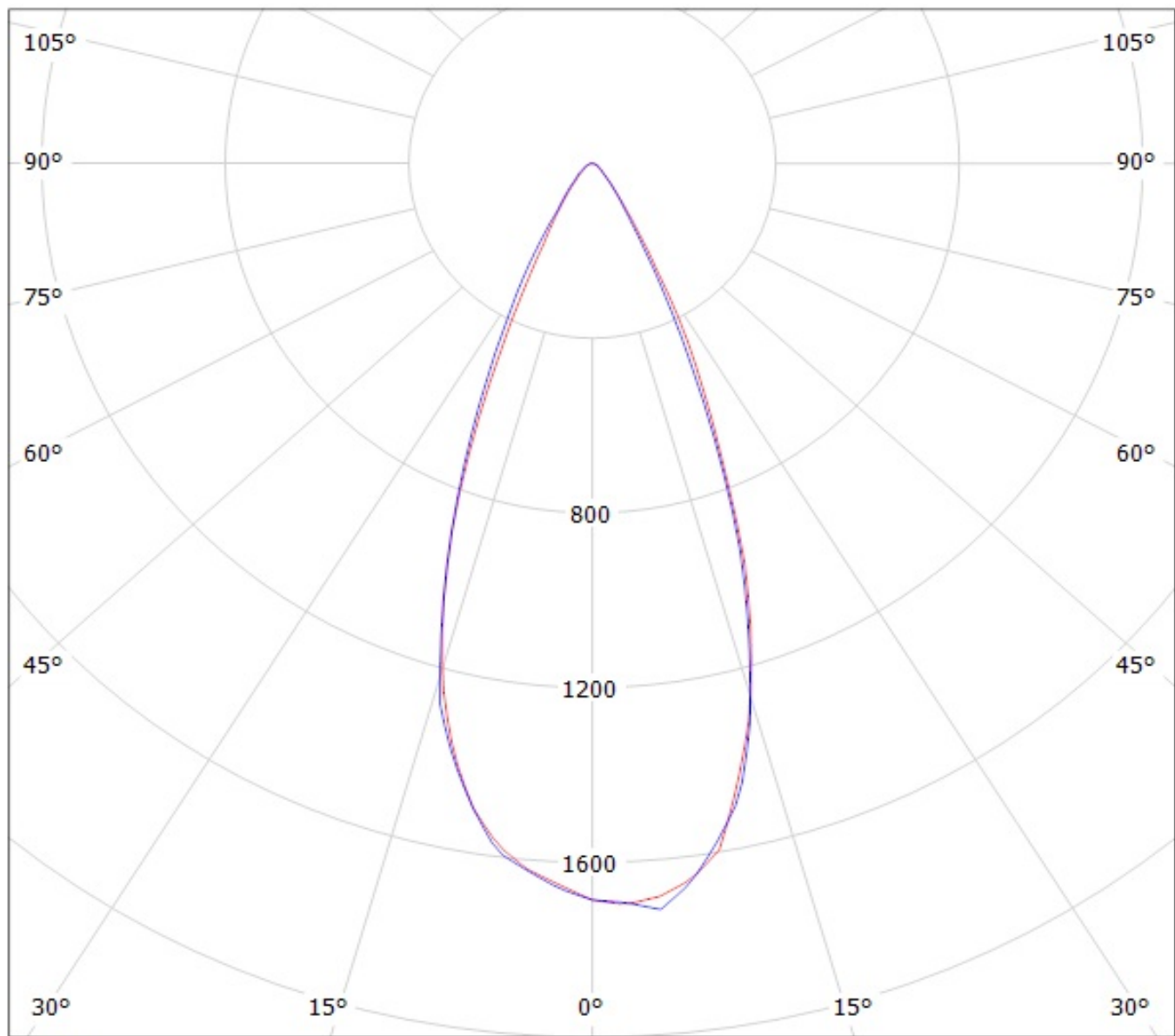

cd/klm
— C0 - C180 — C90 - C270

Luminaire: Ledil Oy CA12426_TINA3-W (Cree XP-G2 98.8lm @ 250mA) Efficiency=91%
Lamps: 1 x Cree XP-G2 98.8lm @ 250mA

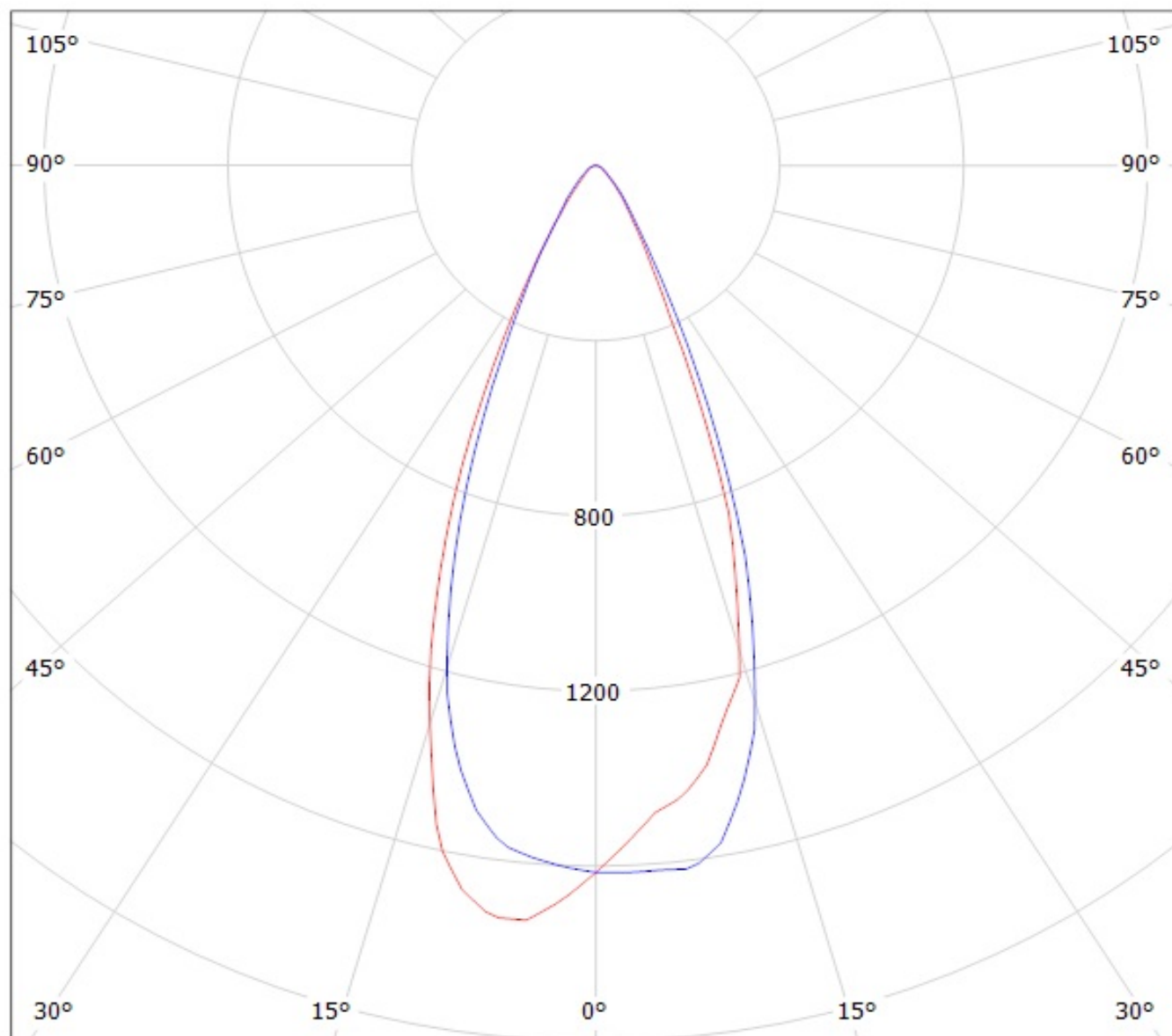

cd/klm

— C0 - C180

— C90 - C270

Luminaire: Ledil Oy CA12426_TINA3-W (Cree XT-E 98lm @ 250mA) Efficiency=88%
Lamps: 1 x Cree XT-E 98lm @ 250mA

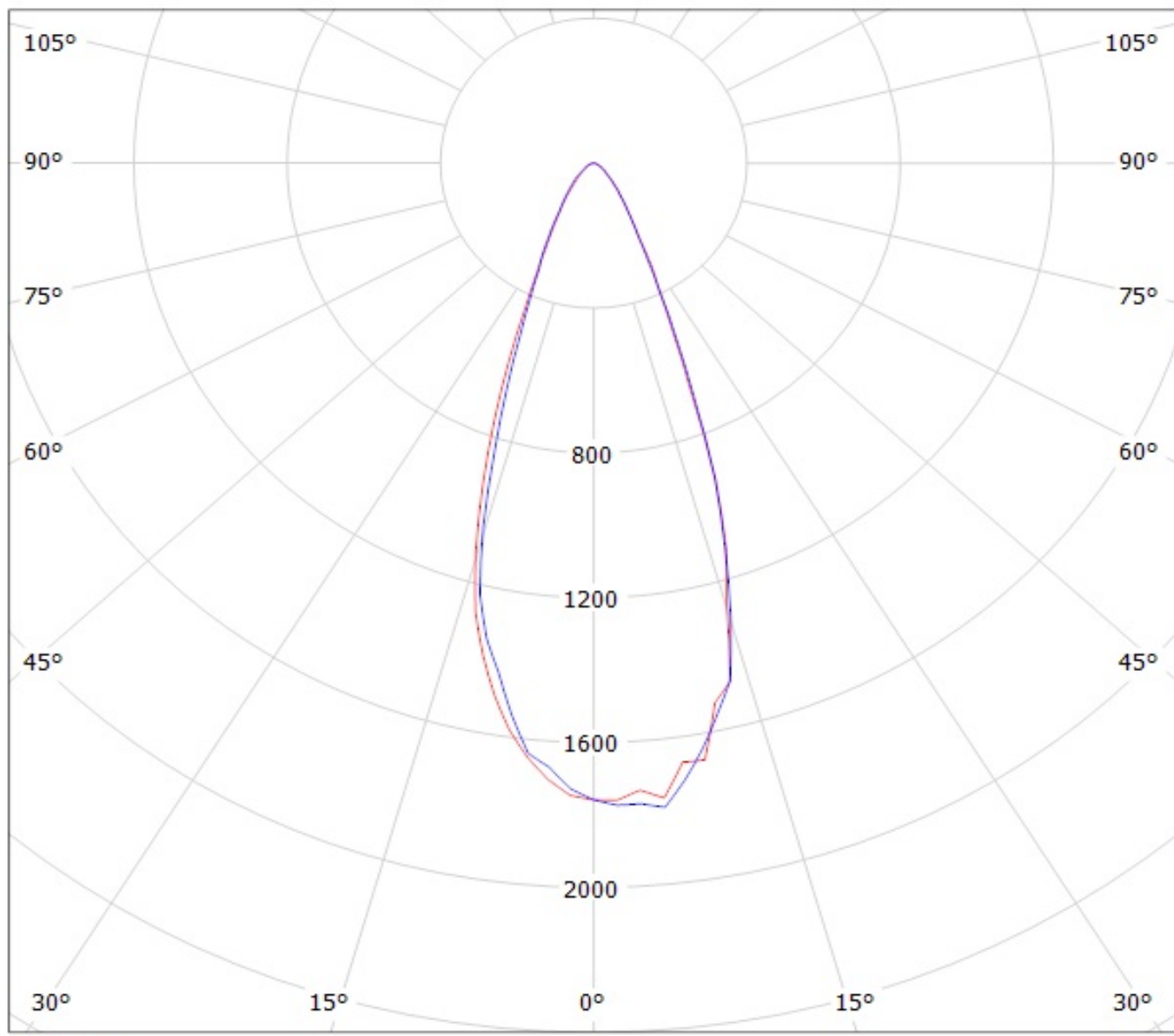

cd/klm
— C0 - C180 — C90 - C270

Luminaire: Ledil Oy CA12426_TINA3-W_(XP-E2) Efficiency=90%
Lamps: 1 x Cree XP-E2 93lm @ 250mA CCT=5600K P=0.8W I=250mA

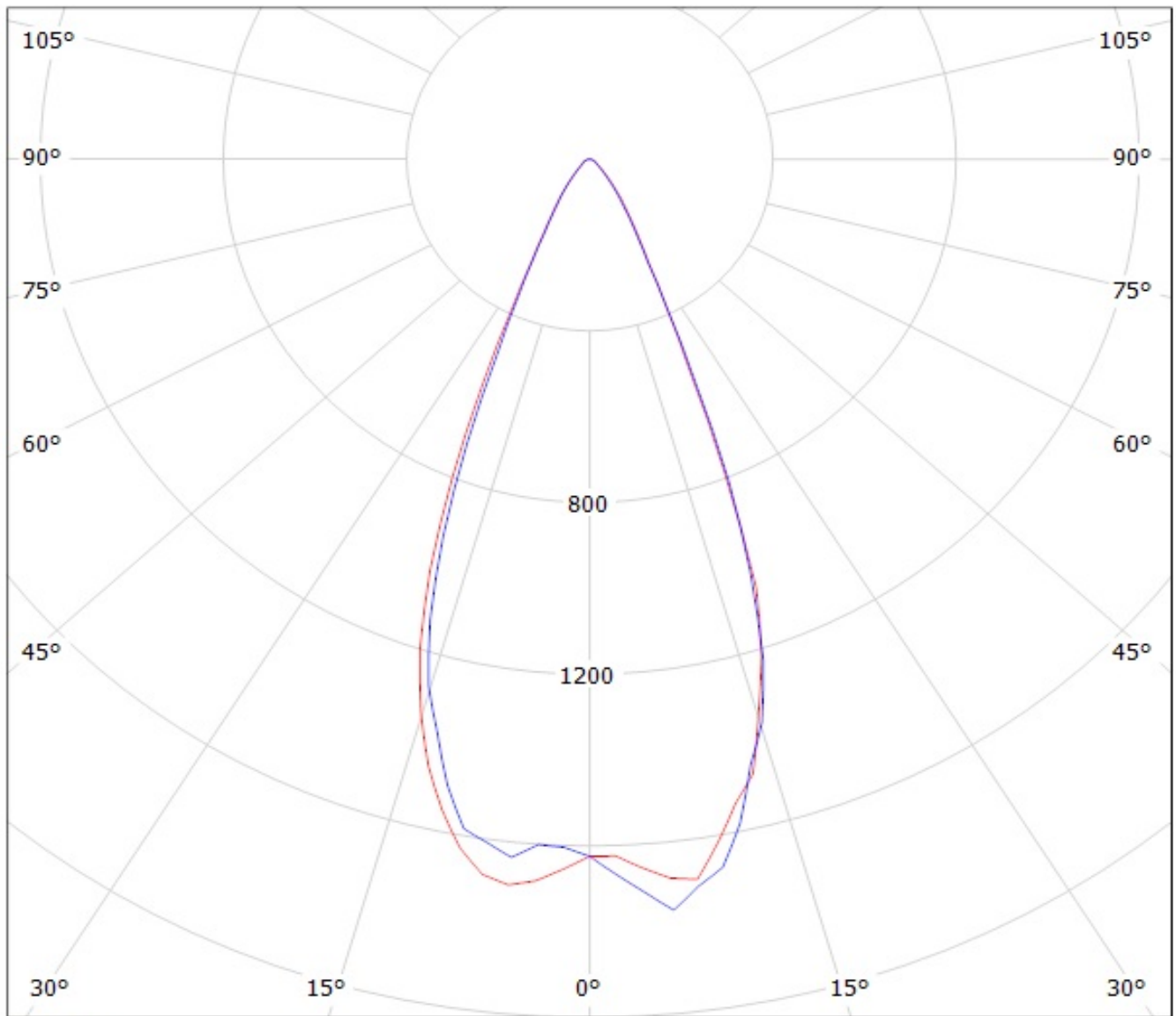

cd/klm

— C0 - C180 — C90 - C270

Luminaire: LEDiL Oy CA12426_TINA3-W_(XP-L_HI)

Lamps: 1 x Cree_XP-L_HI_113.703lm@250mA_P=0.743328W_I=0.2499A

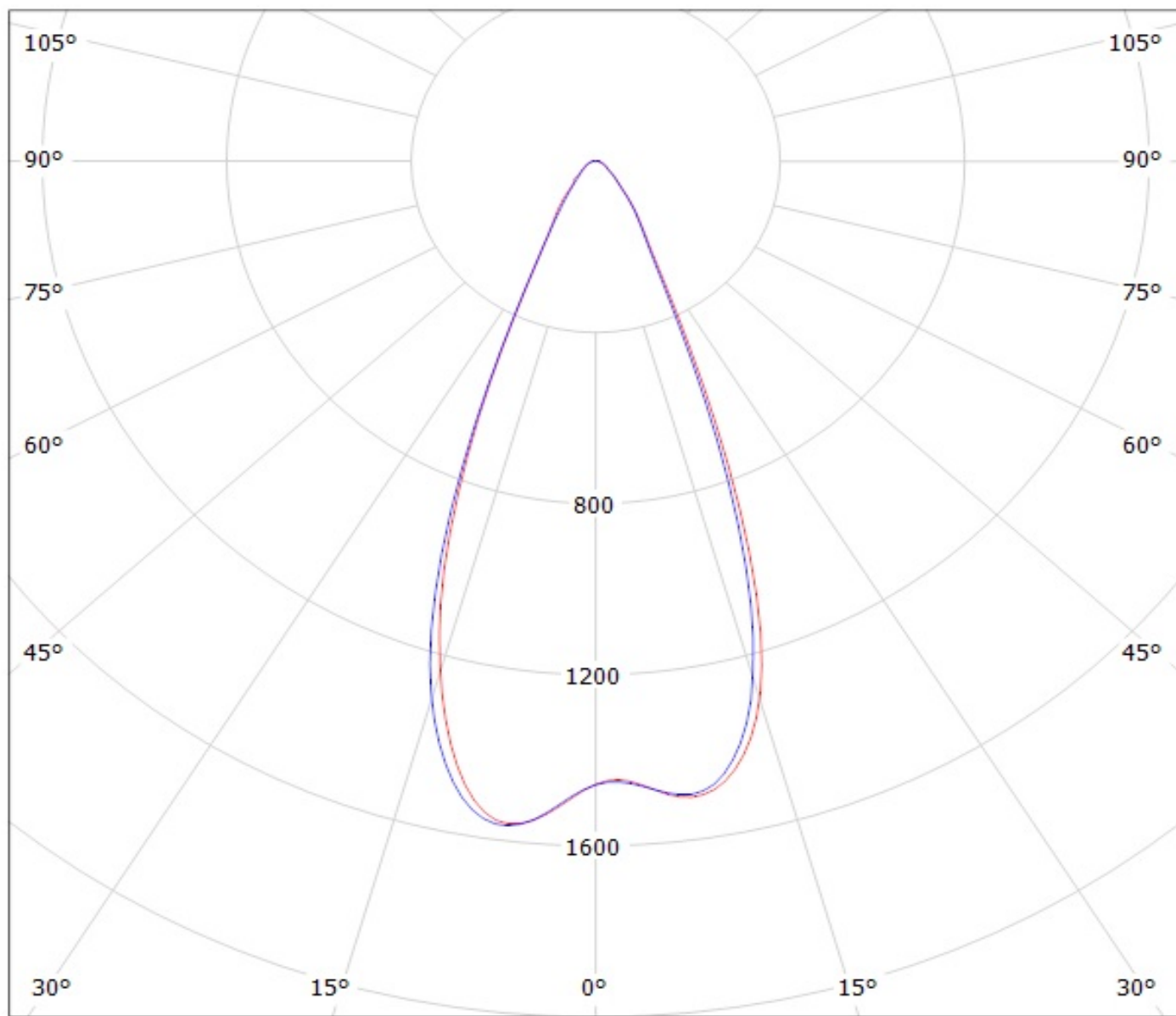

cd/klm

— C0 - C180 — C90 - C270

$\eta = 93\%$

Luminaire: Ledil Oy CA12426_TINA3-W_(XHP35_HI)_SIMULATED
Lamps: 1 x Cree XHP35 HI

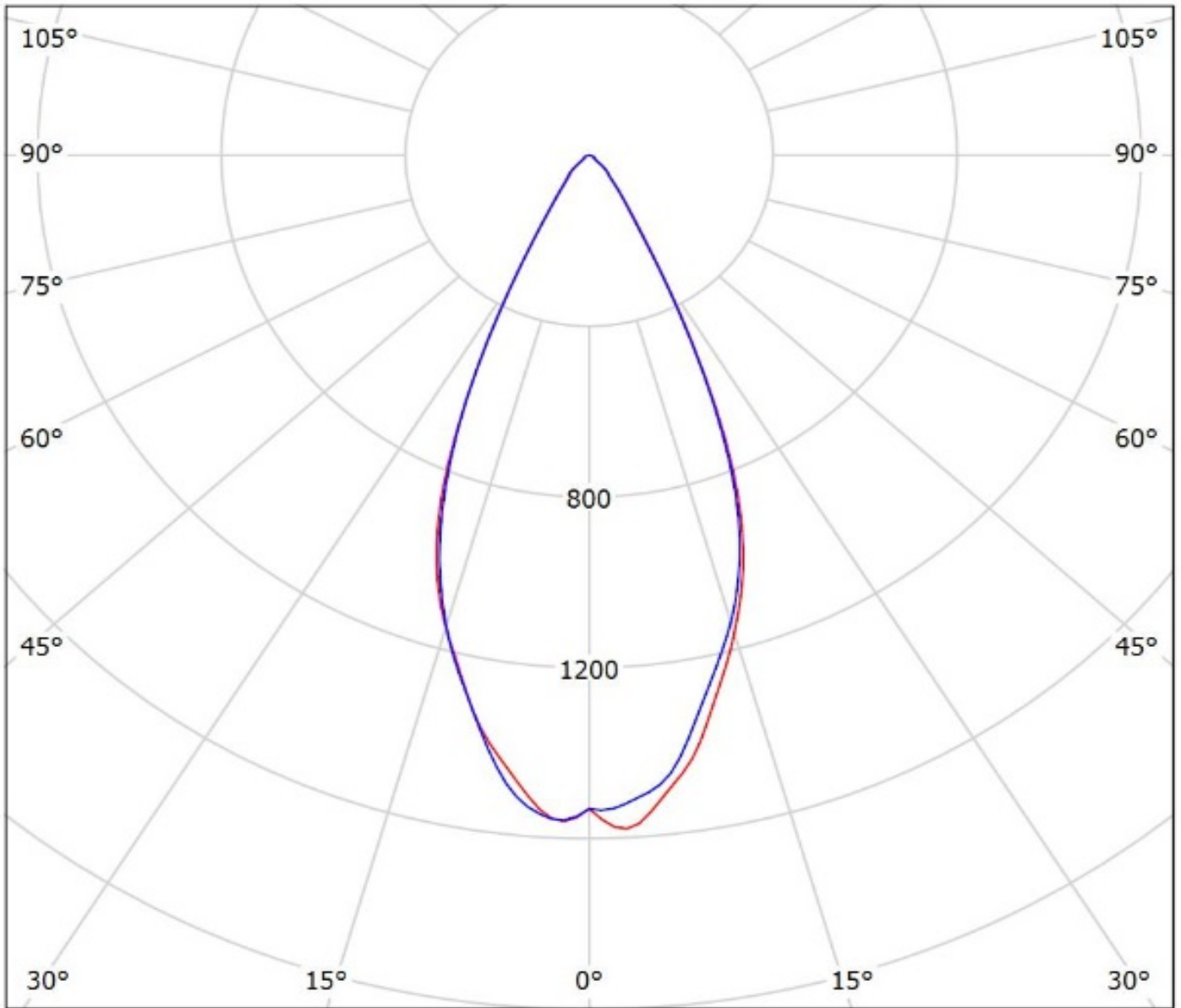

cd/klm
— C0 - C180 — C90 - C270

$\eta = 93\%$

Luminaire: Ledil Oy CA12426_TINA3-W (Luxeon A 64lm @ 250mA) Efficiency=89%
Lamps: 1 x Luxeon A 64lm @ 250mA

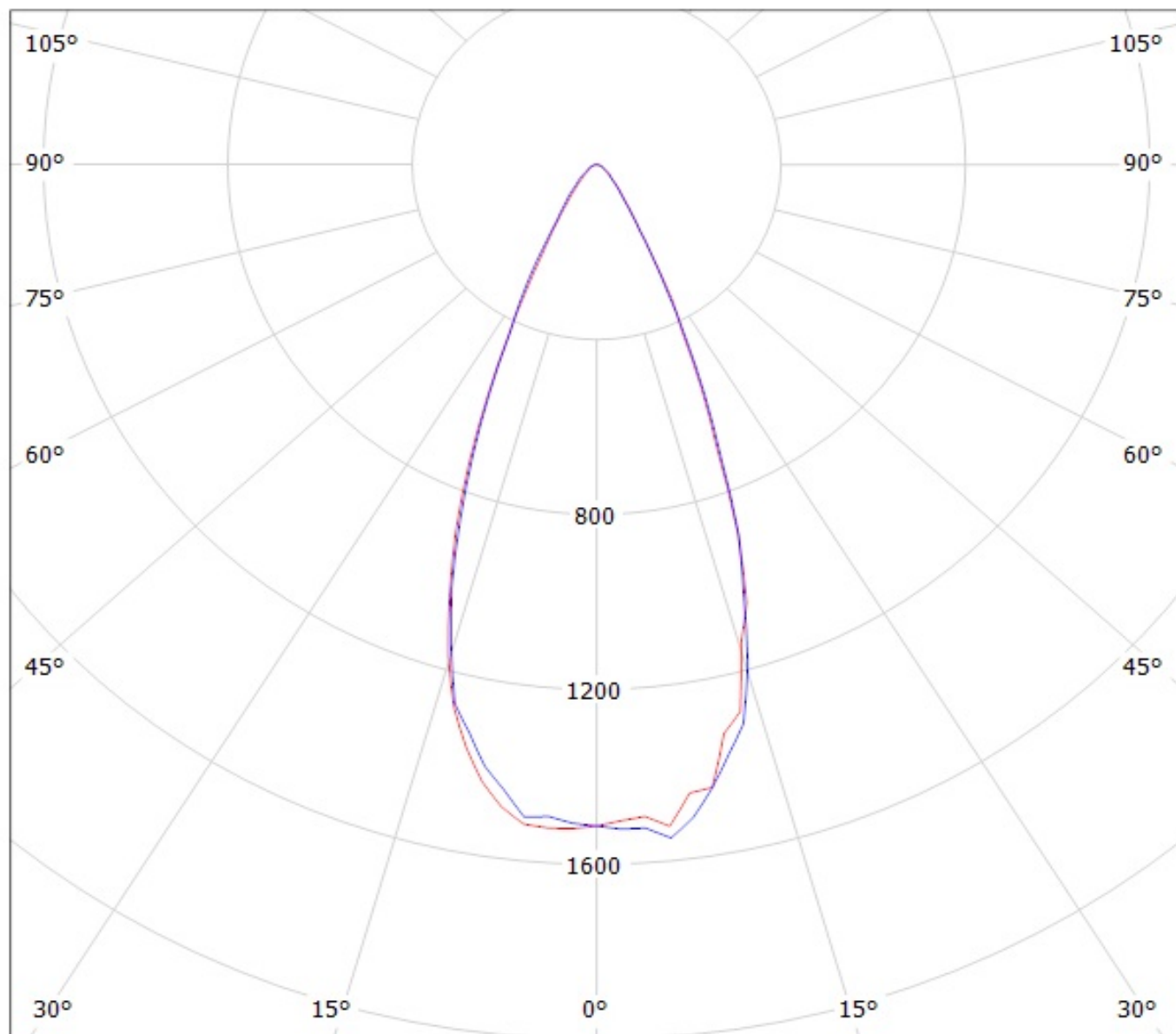

cd/klm

— C0 - C180

— C90 - C270

LEDiL Oy CA12426_TINA3-W_(LUXEON_T)_2 Eff.89.4% / LDC (Polar)

Luminaire: LEDiL Oy CA12426_TINA3-W_(LUXEON_T)_2 Eff.89.4%
Lamps: 1 x LUXEON T (74lm@250mA)

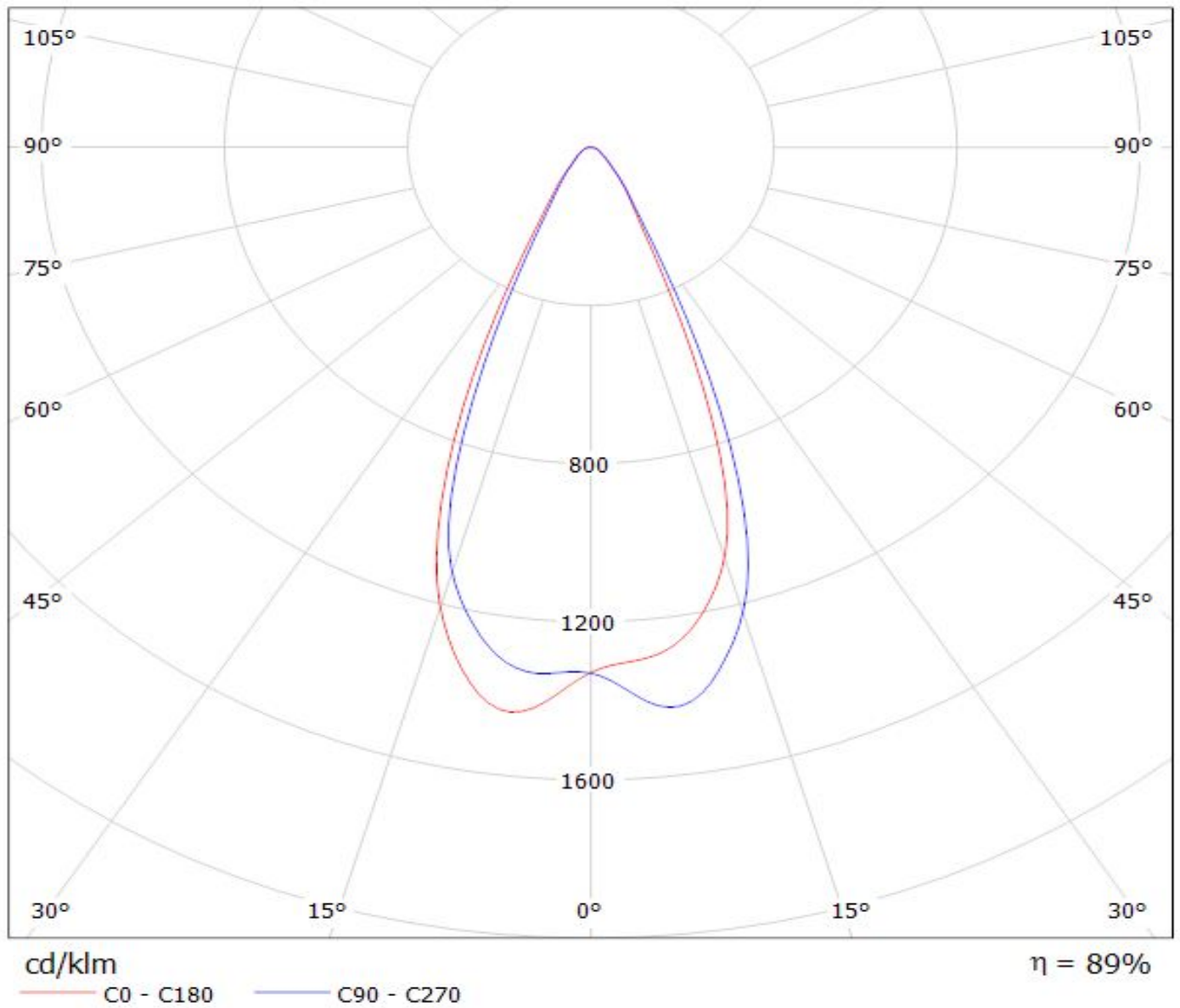

Luminaire: Ledil Oy CA12426_TINA3-W_(Luxeon_TX) Efficiency=89%
Lamps: 1 x Luxeon TX (L1T2-3585) 108lm @ 250mA CCT=3521K P=0.73W I=250mA

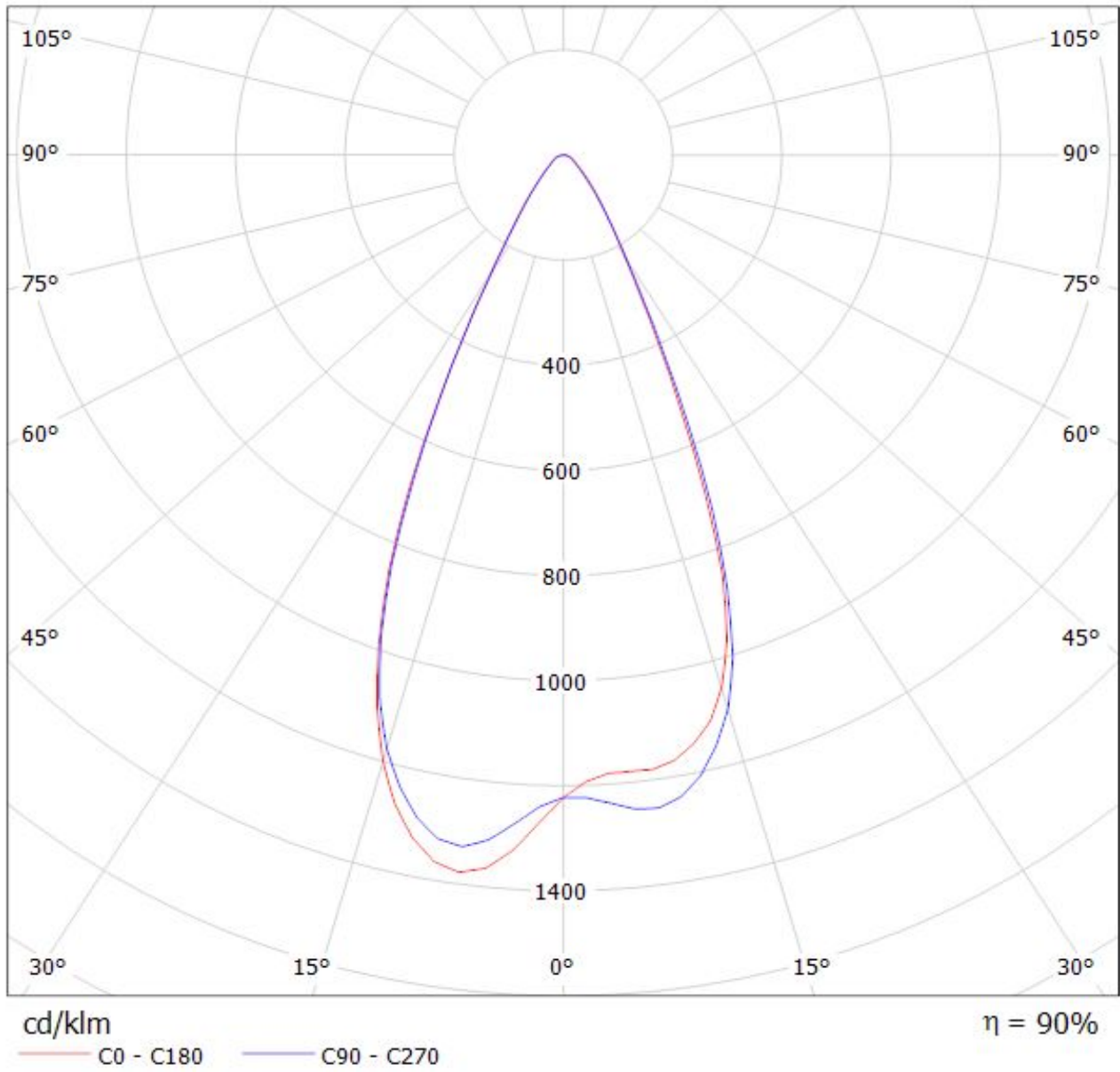

Luminaire: Ledil Oy CA12426_TINA3-W (Nichia NVS19 92lm @ 250mA) Efficiency=86%
Lamps: 1 x Nichia NVS19 92lm @ 250mA

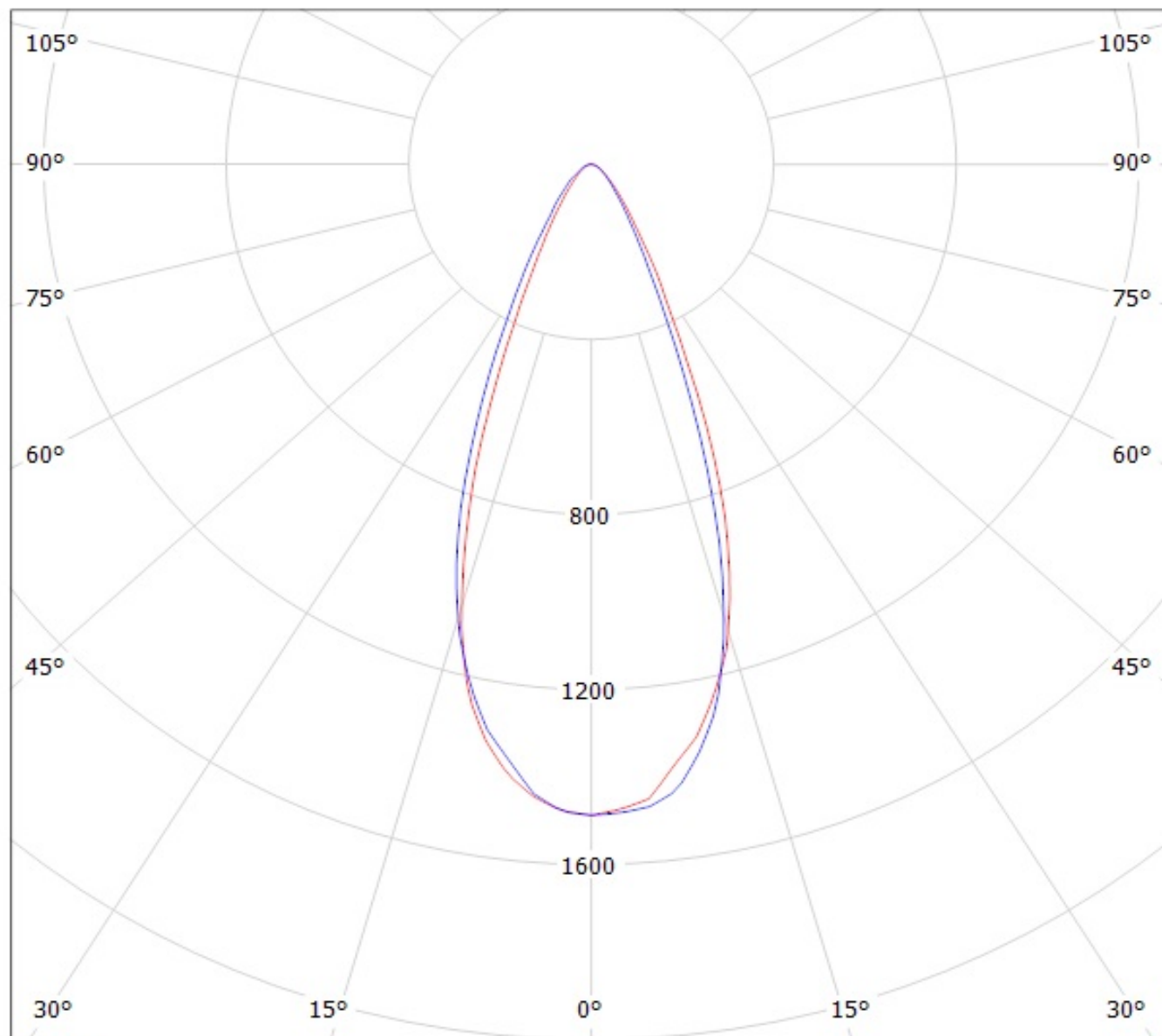

cd/klm

— C0 - C180

— C90 - C270

Luminaire: LEDiL Oy CA12426_TINA3-W_(NVSL219CE)

Lamps: 2 x Nichia_NVSL219CE_101.227lm@250mA_P=0.713404W_I=0.25A

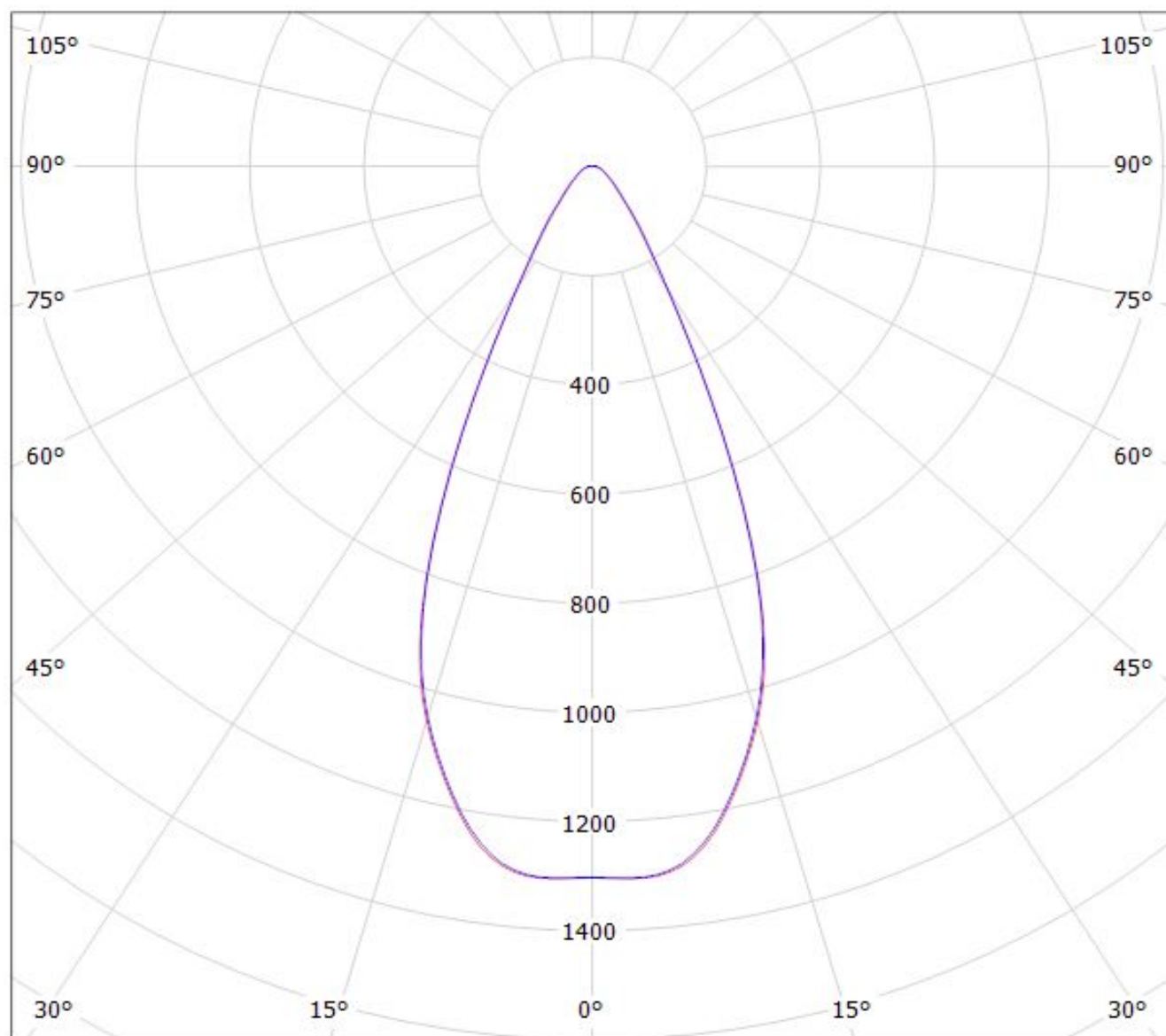

cd/klm

— C0 - C180

— C90 - C270

$\eta = 92\%$

Luminaire: Ledil Oy CA12426_TINA3-W (Osram Square EC 66lm @ 250mA) Efficiency=88%
Lamps: 1 x Osram Square EC 66lm @ 250mA

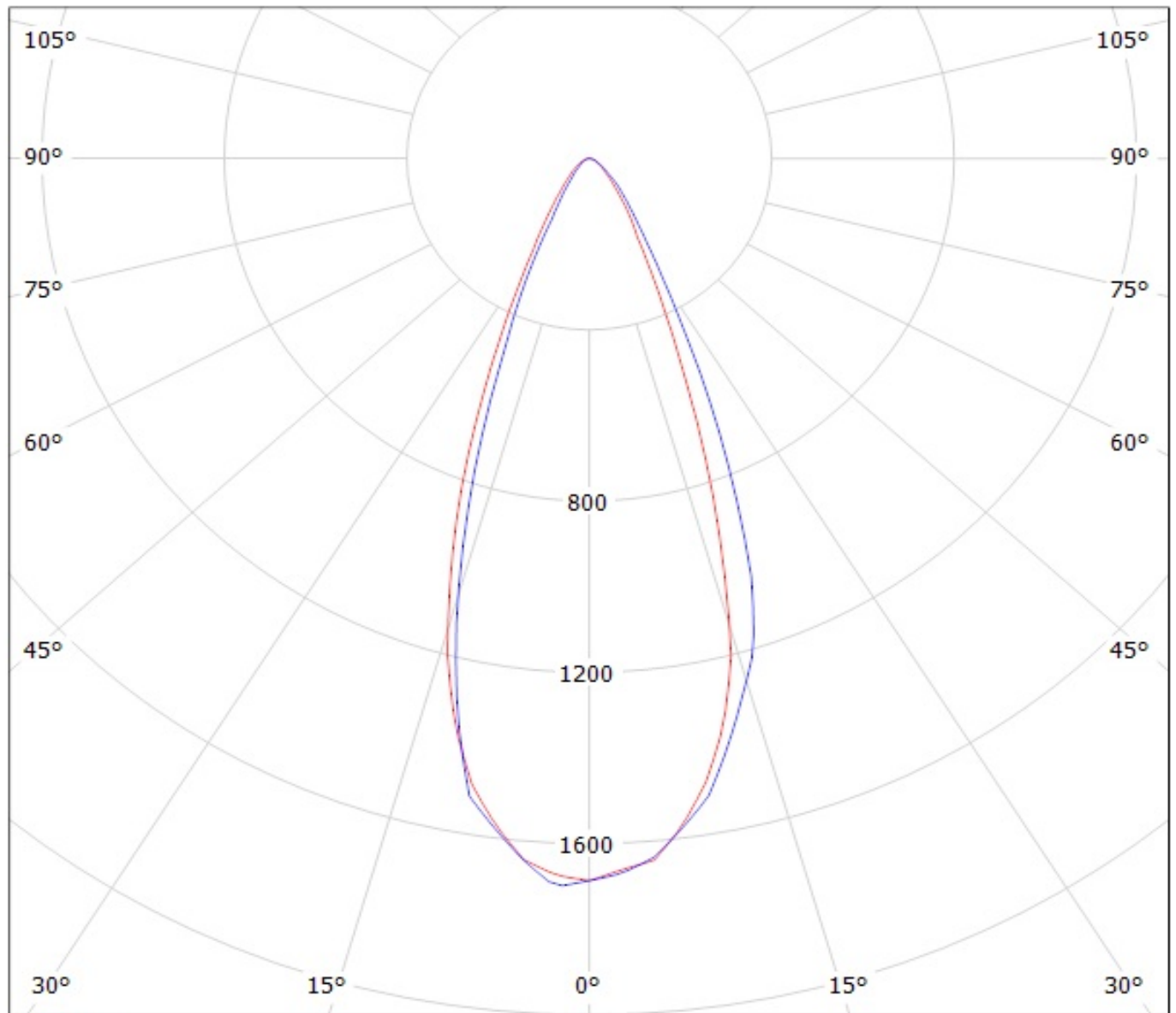

cd/klm

— C0 - C180

— C90 - C270

Luminaire: Ledil Oy CA12426_TINA3-W_(LH351Z) Efficiency=89%
Lamps: 1 x Samsung LH351Z (90.14lm @ 250mA) CCT=6500K P=0.7W I=250mA

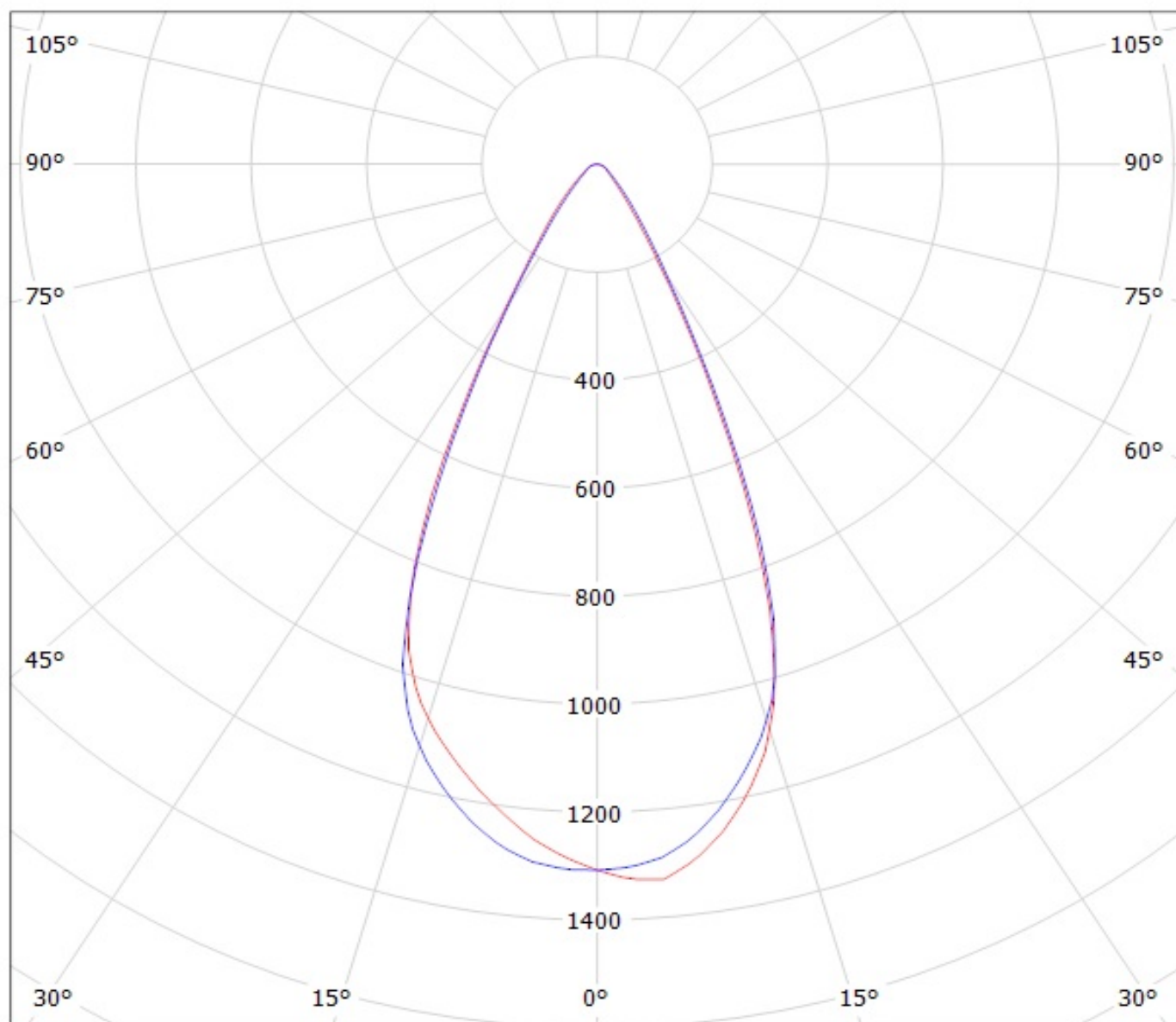

cd/klm

— C0 - C180 — C90 - C270

Luminaire: LEDiL Oy CA12426_TINA3-W_(LH351B)

Lamps: 1 x SAMSUNG_LH351B_107.366lm@250mA_P=2.9308W_I=249.9mA

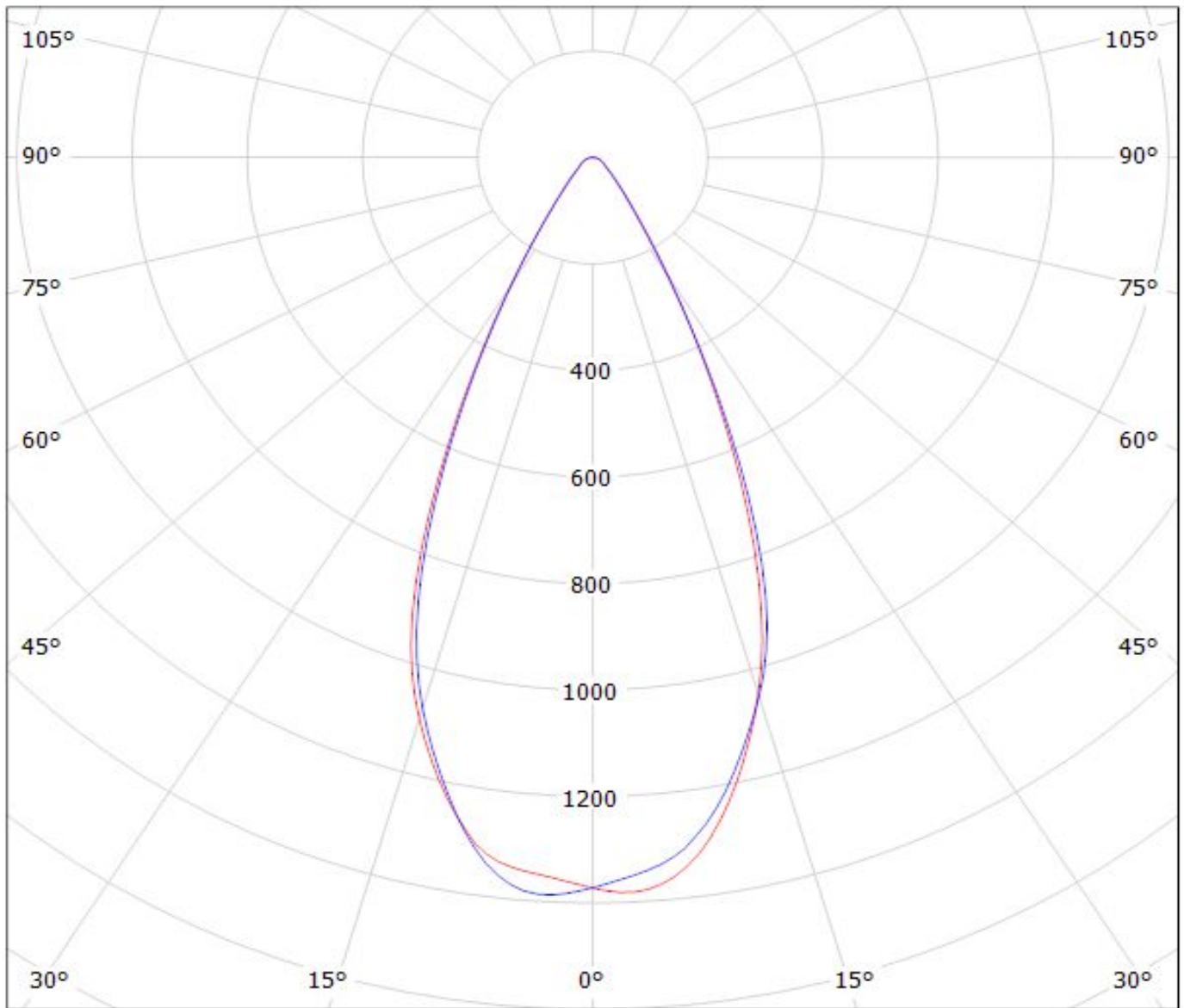

cd/klm

— C0 - C180

— C90 - C270

$\eta = 89\%$

NOTE: The typical divergence will be changed by different color, chip size and chip position tolerance. The typical total divergence is the full angle measured where the luminous intensity is half of the peak value.