

POSITIONS/ CONTACTS	A		B	
	MM±0.20	[INCH±0.008]	MM±0.30	[INCH±0.012]
02/02	1.00	0.039	2.00	0.079
03/03	2.00	0.079	3.00	0.118
04/04	3.00	0.118	4.00	0.157
05/05	4.00	0.157	5.00	0.197
06/06	5.00	0.197	6.00	0.236
07/07	6.00	0.236	7.00	0.276
08/08	7.00	0.276	8.00	0.315
09/09	8.00	0.315	9.00	0.354
10/10	9.00	0.354	10.00	0.394
11/11	10.00	0.394	11.00	0.433
12/12	11.00	0.433	12.00	0.472
13/13	12.00	0.472	13.00	0.512
14/14	13.00	0.512	14.00	0.551
15/15	14.00	0.551	15.00	0.591
16/16	15.00	0.591	16.00	0.630
17/17	16.00	0.630	17.00	0.669
18/18	17.00	0.669	18.00	0.709
19/19	18.00	0.709	19.00	0.748
20/20	19.00	0.748	20.00	0.787
21/21	20.00	0.787	21.00	0.827
22/22	21.00	0.827	22.00	0.866
23/23	22.00	0.866	23.00	0.906
24/24	23.00	0.906	24.00	0.945
25/25	24.00	0.945	25.00	0.984
26/26	25.00	0.984	26.00	1.024
27/27	26.00	1.024	27.00	1.063
28/28	27.00	1.063	28.00	1.102
29/29	28.00	1.102	29.00	1.142
30/30	29.00	1.142	30.00	1.181
31/31	30.00	1.181	31.00	1.220
32/32	31.00	1.220	32.00	1.260
33/33	32.00	1.260	33.00	1.299
34/34	33.00	1.299	34.00	1.339
35/35	34.00	1.339	35.00	1.378
36/36	35.00	1.378	36.00	1.417
37/37	36.00	1.417	37.00	1.457
38/38	37.00	1.457	38.00	1.496
39/39	38.00	1.496	39.00	1.535
40/40	39.00	1.535	40.00	1.575
41/41	40.00	1.575	41.00	1.614
42/42	41.00	1.614	42.00	1.654
43/43	42.00	1.654	43.00	1.693
44/44	43.00	1.693	44.00	1.732
45/45	44.00	1.732	45.00	1.772
46/46	45.00	1.772	46.00	1.811
47/47	46.00	1.811	47.00	1.850
48/48	47.00	1.850	48.00	1.890
49/49	48.00	1.890	49.00	1.929
50/50	49.00	1.929	50.00	1.969

PART NUMBER CODING
SMH100-LP_E-S__-S_-BK

MOUNTING STYLES

- C - SURFACE MOUNT, SINGLE ROW
PIN 1 (STANDARD)
- D - SURFACE MOUNT, SINGLE ROW
PIN 1 (OPPOSITE BEND)

NUMBER OF POSITIONS
 (CONTACTS PER ROW, 2 THRU 50)

PLATING

- P = GOLD FLASH OVERALL.
- S = 10u" GOLD OVERALL.

REVISIONS				
REV.	ECO. NO	DESCRIPTION	DATE	BY
A	1910	INITIAL RELEASE	2/5/2009	JH

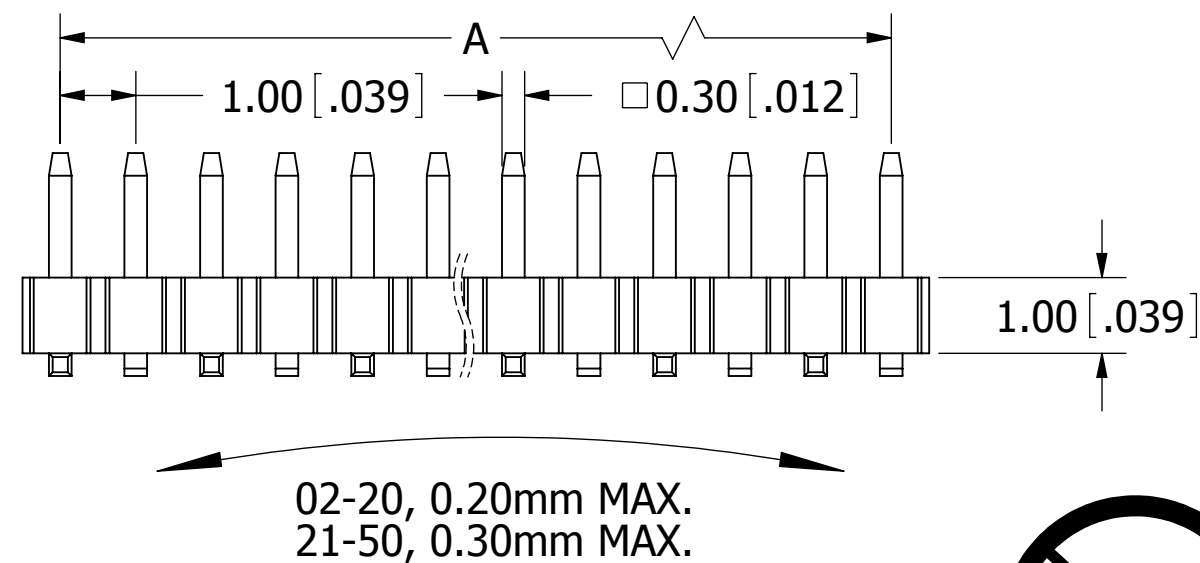
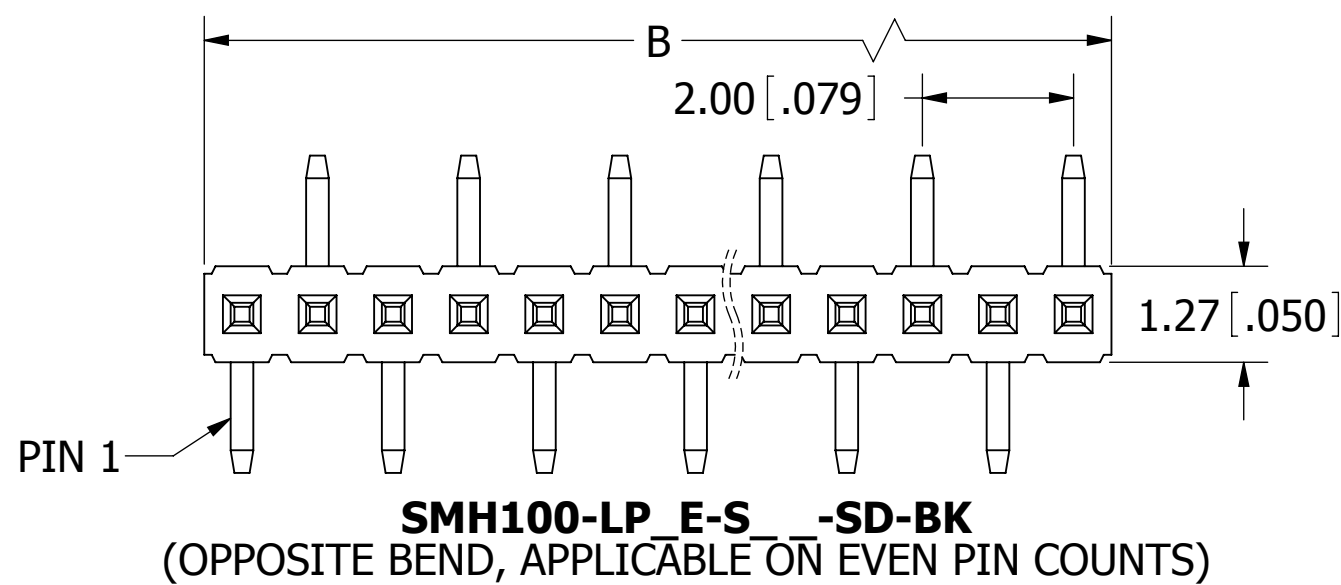
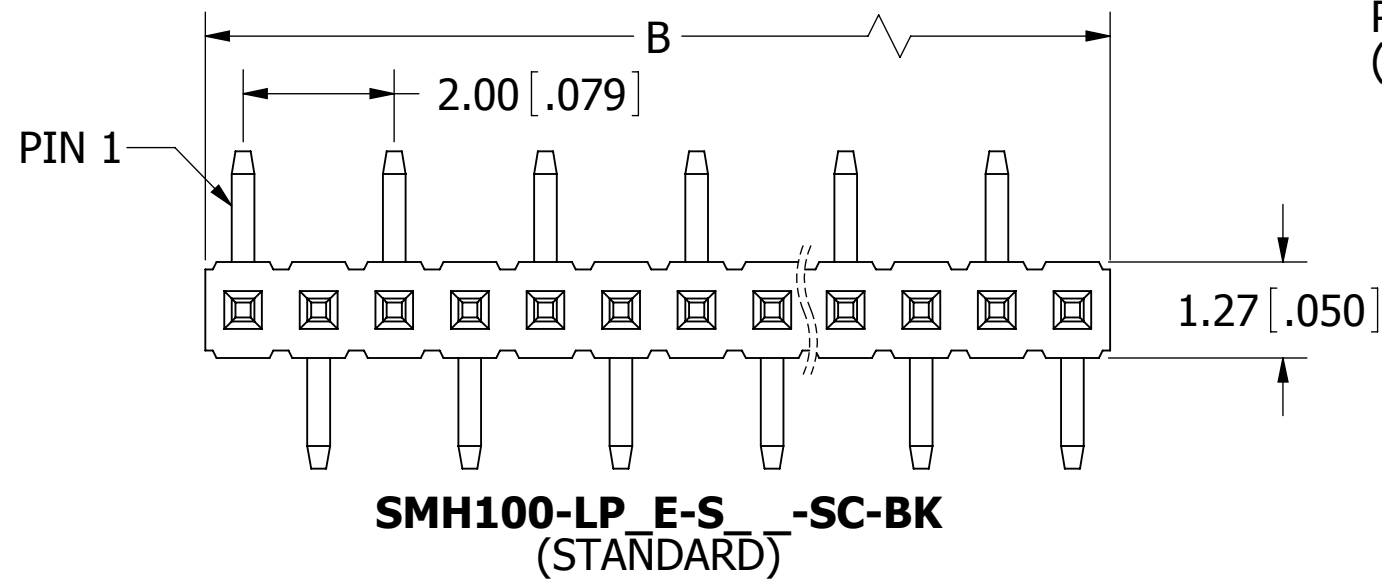
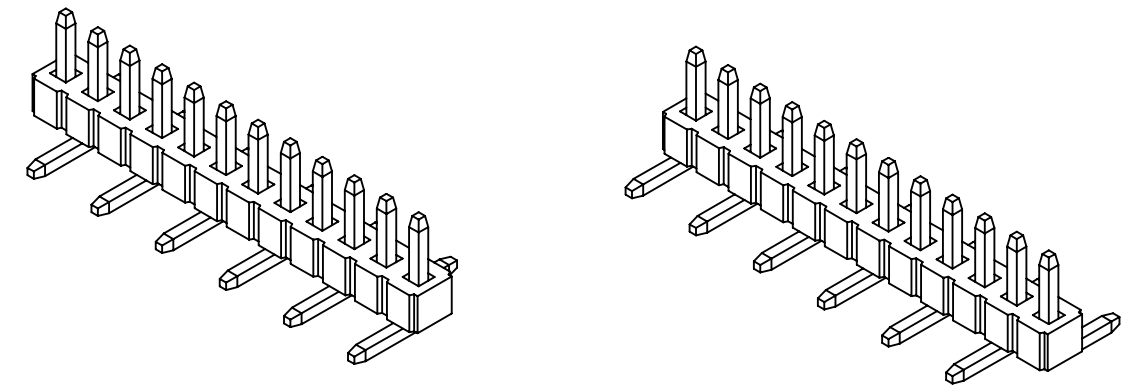

PIN 1
(C MOUNTING)

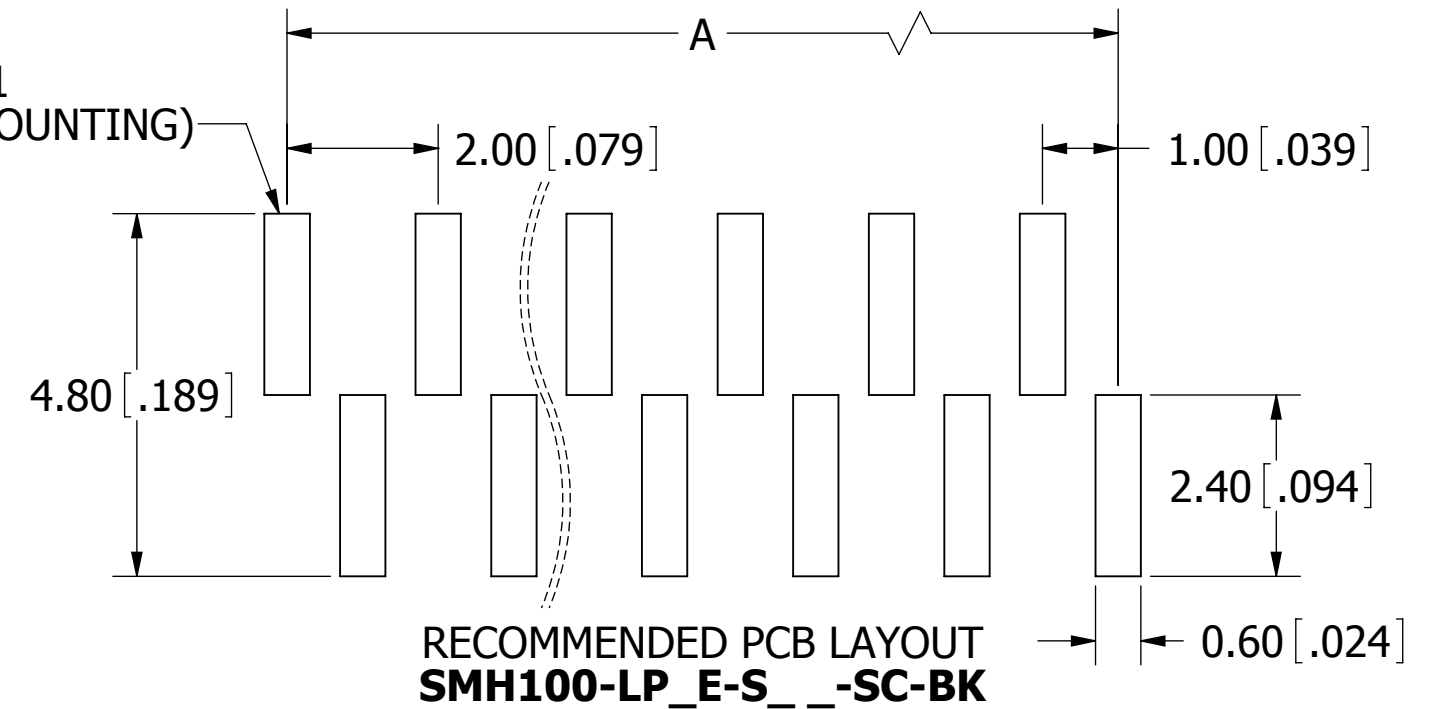

PIN 1
(D MOUNTING)

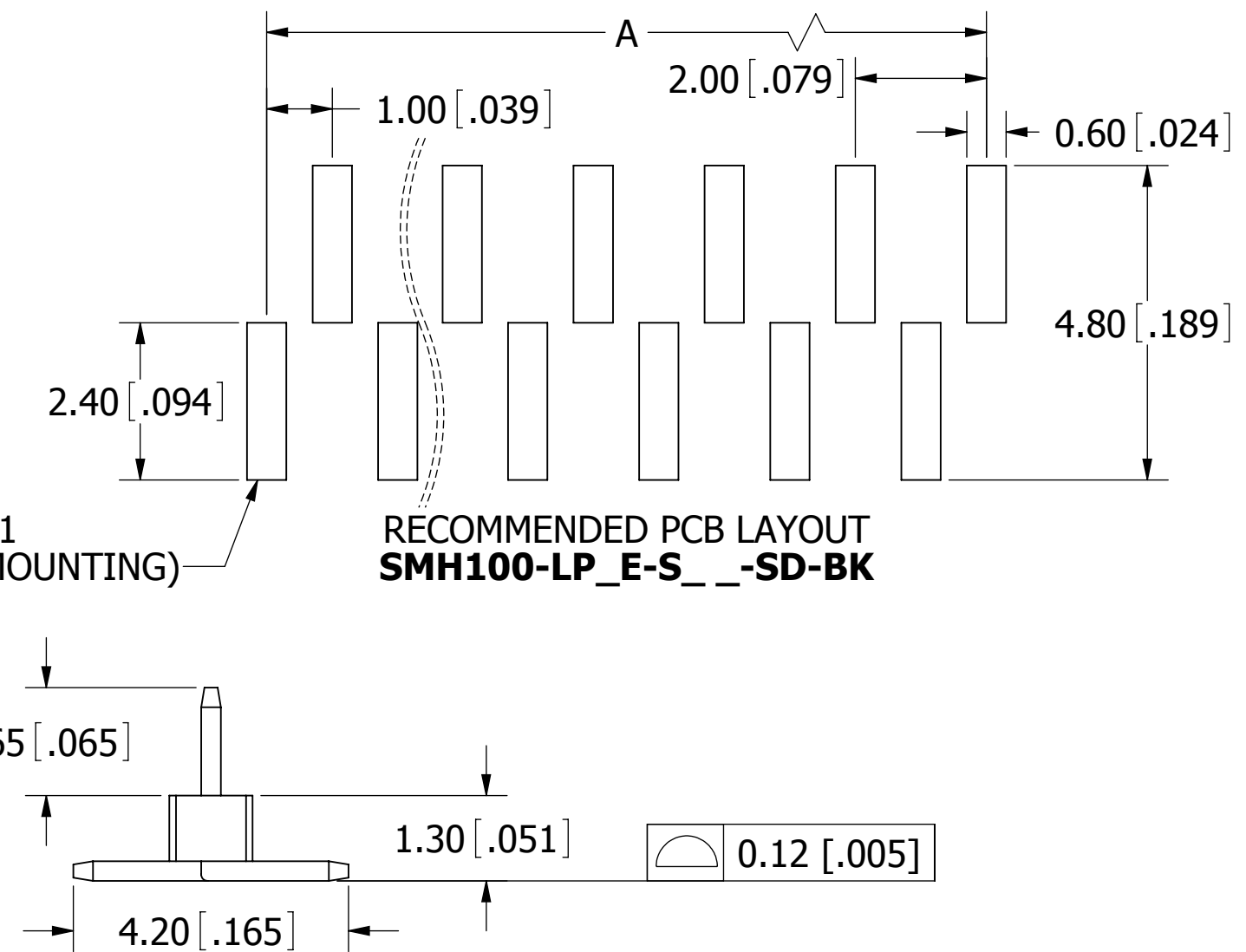

- NOTES:**
- INSULATOR MATERIAL: L.C.P, UL 94V-0, BLACK COLOR.
 - CONTACT MATERIAL: PHOSPHOR BRONZE.
 - CONTACT PLATING: SEE PART NUMBER CODING.
 - CURRENT RATING: 1 AMP.
 - INSULATOR RESISTANCE: 1000 MEGA OHMS MIN.
 - CONTACT RESISTANCE: 20 MILLI OHMS MAX.
 - DIELECTRIC WITHSTANDING: AC 300V.
 - OPERATING TEMPERATURE: -40° C TO +125° C.
 - PROCESSING TEMP.: 260° C FOR 10 SECS MAX.
(INDICATED TEMPERATURE AND TIME IS FOR COMPONENT INSULATOR. HIGHER PROCESSING TEMPERATURES MAY BE USED, PROVIDED HEAT IS APPLIED FROM BACK SIDE OF PCB, AND INSULATOR DOES NOT EXCEED INDICATED TEMPERATURE AND TIME.)

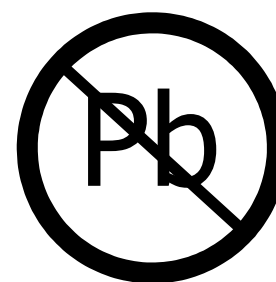

RoHS COMPLIANT

UNLESS OTHERWISE SPECIFIED:
 DIMENSIONS ARE IN MM [INCHES]
 TOLERANCES:
 ANGULAR: ± 5°
 .X = ± .30 [.012]
 .XX = ± .20 [.008]
 .XXX = ± .10 [.004]
 SURFACE FINISH: 63 Ra
 REMOVE ALL BURRS AND SHARP EDGES .010 MAX

INTERPRET DIMENSIONS AND GEOMETRIC TOLERANCING PER: ANSI Y14.5M-1994

DATE	NAME	DRAWN	DATE	NAME
2/05/09	JH			

THE INFORMATION HEREIN CONTAINS PROPRIETARY INFORMATION OF SULLINS ELECTRONICS AND IS NOT TO BE REPRODUCED, USED OR DISCLOSED TO OTHERS FOR ANY PURPOSE EXCEPT AS SPECIFICALLY AUTHORIZED IN WRITING BY AN OFFICER OF SULLINS ELECTRONICS.

SULLINS
CONNECTOR SOLUTIONS

DESCRIPTION
 HEADER, MALE 1mm CC, 1 ROW, SMT

PART NUMBER
SMH100-LP_E-S__-S_-BK

SIZE DWG. NO. REV
C 11190 **A**

SCALE: 16:1 SHEET 1 OF 1