

USER'S GUIDE

K17A Series

Touch Screen LCD Monitors



TR Touch
Revolution

Rev.A

The information contained in this document is subject to change without notice.

This document contains proprietary information that is protected by copyright. All rights are reserved. No part of this document may be reproduced, translated to another language or stored in a retrieval system, or transmitted by any means, electronic, mechanical, photocopying, recording, or otherwise, without prior written permission. Windows is a registered trademark of Microsoft, Inc. Other brand or product names are trademarks of their respective holders.

The test results show that this device meets the FCC rules. Those limits are set to protect residential areas from the devices with harmful emission. This device will produce, use and radiate radio frequency energy. In addition, failure to follow the user's manual to install or use this device might produce harmful interference with radio communication. Notwithstanding the foregoing, it does not guarantee that this type of harmful interference does not occur in some special installations. The interference caused by this device to the reception of radio or television signals may be verified by turning it on and off. Any changes or modifications to this TFT LCD would void the user's authority to operate this device.

Important Recycle Instruction:

 LCD lamps inside this product may contain mercury. This product may contain other electronic waste that can be hazardous if not disposed of properly. Recycle or dispose in accordance with local, state, or federal Laws. For more information, contact the Electronic Industries Alliance at WWW.EIAE.ORG. For lamp specific disposal information check WWW.LAMPRECYCLE.ORG.

Table of Contents

Usage Notice

Precautions.....	1
------------------	---

Introduction

About K17A Series	2
Touch Screen for K17A Series	2
Package Overview	3

Installation

Product Overview	4
Front View	4
Bottom View	4
Attaching the L-Brackets.....	5
Side Mount for Your Monitor	6
Customer panel material.....	7
Connecting the Display (Figure 9.1).....	8
(Figure 9.1)	9

User Controls

Back Panel Controls	10
How to Use the OSD Menus	11
On-Screen Display Menus	12

Appendix

Troubleshooting.....	13
Warning Signal	14
No Signal.....	14
Going to Sleep.....	14
Out of Range	14
Product Dimensions	15
Compatibility Modes	16
Touch Screen Driver Install.....	17
K17A Series Calibration Instructions.....	17

Usage Notice



Warning - To prevent the risk of fire or shock hazards, do not expose this product to rain or moisture.



Warning - Please do not open or disassemble the product as this may cause electric shock.

Precautions

Follow all warnings, precautions and maintenance as recommended in this user's manual to maximize the life of your unit.

Do:

- Turn off the product before cleaning.
- Touch screen surface may be cleaned using a soft clean cloth moistened with mild window glass commercial cleaners or 50/50 mixture of water and isopropyl alcohol.
- Use a soft cloth moistened with mild detergent to clean the display housing.

Don't:

- Do not touch the LCD Display screen surface with sharp or hard objects.
- Do not use abrasive cleaners.
- Do not operate the product under the following conditions:
 - Extremely hot, cold or humid environment.
 - Areas susceptible to excessive dust and dirt.
 - Near any appliance generating a strong magnetic field.
 - In direct sunlight.

Introduction

About K17A Series

The K17A Series is a 17" flat panel screen with an active matrix, thin-film transistor (TFT) liquid crystal display (LCD).

Features include:

- Direct Analog signal input
- Active matrix TFT LCD technology
- 1280x1024 SXGA resolution
- 17" viewable display area
- 31.47 ~ 80 kHz horizontal scan
- 56 ~ 75 Hz high refresh rate
- 0.264mm x 0.264mm Pixel pitch
- Auto adjustment function
- Multilingual OSD user controls
- 75 mm / 100 mm VESA mount
- Bracket mount
- K17A Series - Projected Capacitive touch screen with USB controller

Touch Screen for K17A Series

- Projected Capacitive touch screen for finger input only
- Surface: Clear glass
- Interface: USB controller
- HID Multi-Touch: Windows 7
- HID Single Touch: Windows Vista, XP, 2000, ME, 98
- Driver Support: Vista and XP (TUIO), Linux – Certain Platforms, Mac OS 10.5.8 above

Package Overview



LCD Display

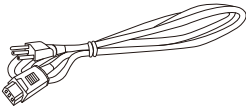

Power Cord

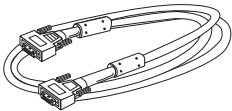

VGA Signal Cable



USB Cable (A to B)

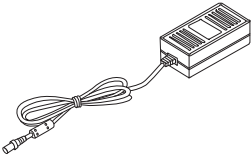

DC Power Supply

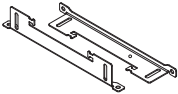

Brackets

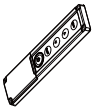

Remote Key
(sold separately)

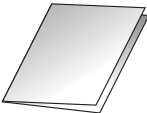

Quick Start Guide



Screws

Installation

Product Overview

- **Front View**

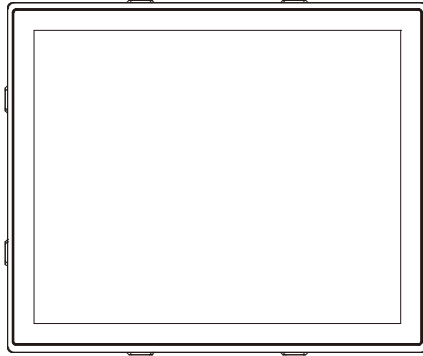

- **Bottom View**

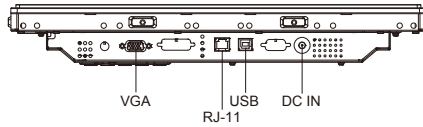

Attaching the L-Brackets

Depending on your mounting scheme, alternately, you may use the L-brackets to mount your displays onto your wall or device.

Find a suitable location for attaching L-brackets.

- A. The left and right sides
- B. The Top and bottom sides

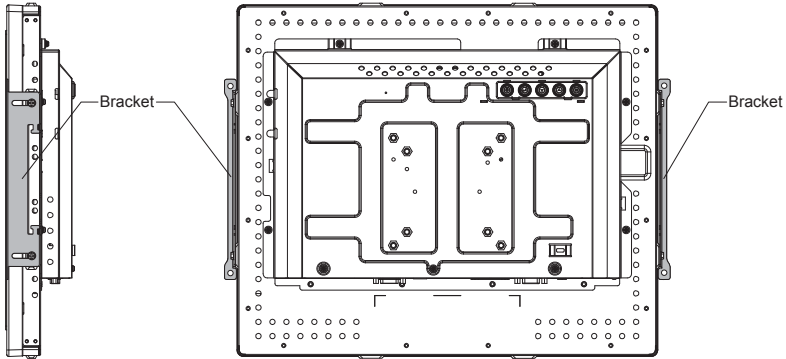

OR

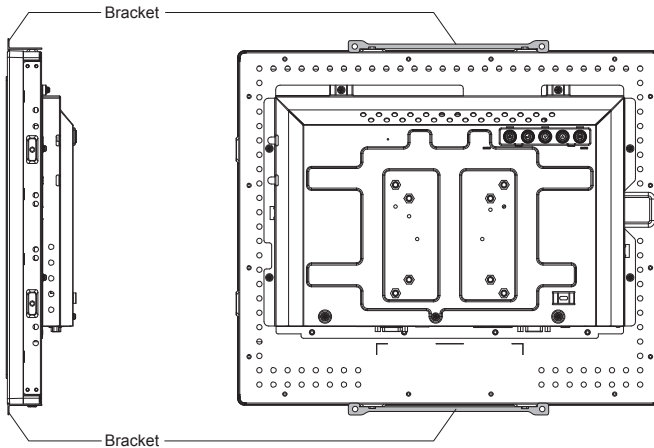

Note:

You will need a screwdriver to attach the L-brackets.

Your kiosk touch monitor included two L-brackets (and four screws, M4x6).

This equipment is intended to be mounted in accordance with the proper hardware and the installation instructions supplied with the product. Use of mounting brackets or screws other than those specified in the installation instructions may cause a hazard.

Side Mount for Your Monitor

This monitor can be mounted to the wooden or concrete wall with 4 screws and a pair brackets on the opposites.

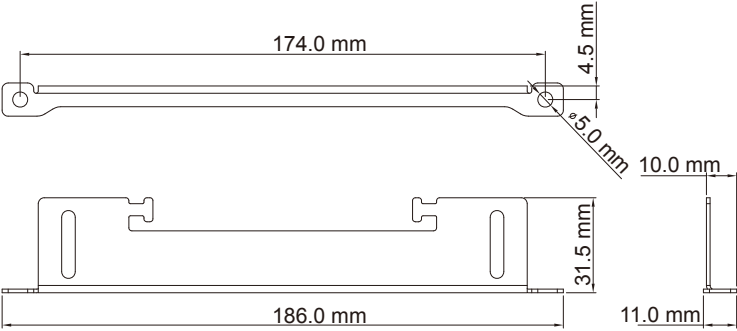
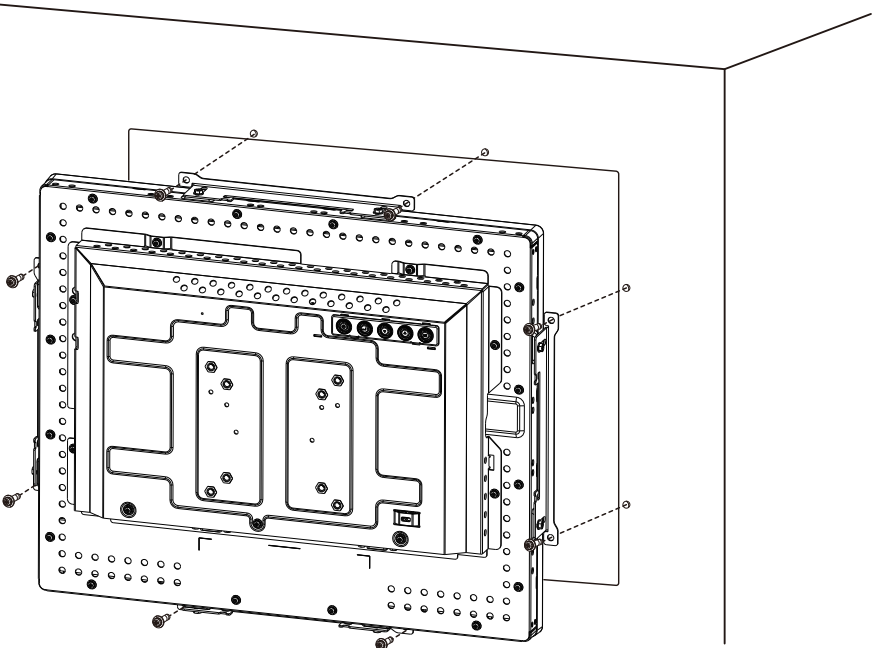

Connecting the Display (Figure 9.1)

To setup this display, please refer to the following figure and procedures.

1. Be sure all equipment is turned off.
2. Connect the DC adapter to the power connector on the monitor and the other end into an electrical outlet (9.1).
3. Connect the D-SUB cable from the display's VGA input connector to the D-SUB connector of your host computer and tighten the screws (9.1).
4. Connect the USB cable from the USB port of your display to the USB port (9.1) of your computer.
5. Configure the touch screen. Refer to the "Touch Screen Driver Installation" section on page 17.
6. Once the touch screen is configured, the monitor is ready for use.
7. Connect the remote control cable to RJ11 port (9.1) (optional).

Notice!

To ensure the LCD display works well with your computer, please configure the display mode of your graphics card to make it less than or equal to 1024 x 768 resolution and make sure the timing of the display mode is compatible with the LCD display.

We have listed the compatible "Video Modes" of your LCD display in the appendix (on page 16) for your reference.

Don't connect telephone or internet cable to RJ-11 port.

Adapter rating: 12Vdc 3A min., marked with LPS.

(Figure 9.1)

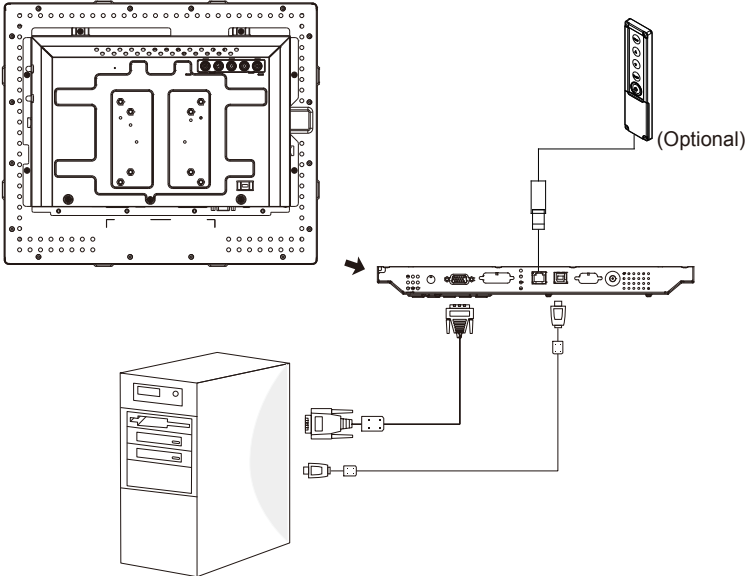



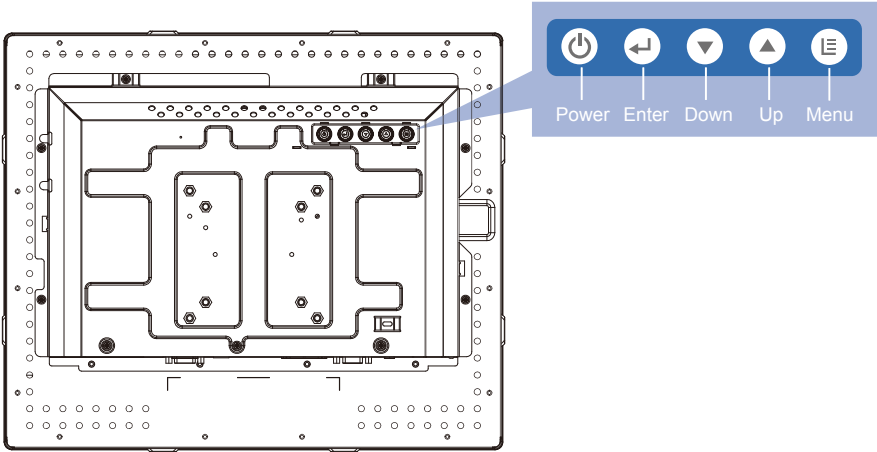

User Controls

Back Panel Controls



OSD Key	Menu off status	Menu on status
☰	Menu appear	Menu disappear/return to main item
▲	Brightness	Main item select up/Adjust up
▼	Contrast	Main item select down/Adjust down
↵	Enter/Select sub-item function	
⏻	Power On/Off	

How to Use the OSD Menu

Icon	Key Name
	Menu
	Up
	Down
	Enter
	Power

1. Press the “MENU” button to pop up the “on-screen menu” and press “Up” or “Down” button to select among the five functions in the main menus.
2. Choose the adjustment items by pressing the “Enter ” button.
3. Adjust the value of the adjustment items by pressing the “Up” or “Down” button.
4. With the OSD menu on screen, press “ Menu” button to return main menu or exit OSD.
5. The OSD menu will automatically close, if you have left it idle for a pre-set time.
6. To Lock the OSD / Power menu buttons, please follow the instructions below.
(Please note: the monitor has to be turned ON with a valid signal pre-set)
 - (a.) Press “Menu” key , the OSD menu will pops upon display.
 - (b.) Press and hold the “Menu” key again with the OSD menu on the screen, the OSD menu will disappear. Then press the “Power” key 1 time while the menu key is still being pressed. The “Lock/Unlock” menu will appear for 3 seconds.
 - (c.) Use the “Enter” key to select OSD or Power setting then set at “Lock” by pushing the “UP” or “Down” button.
 - (d.) When the “UP” or “Down” button is released, the previous setting will be saved and exit the “Lock/Unlock” menu automatically.
7. To Unlock the OSD / Power menu buttons, please follow the instructions below.
(Please note: the monitor has to be turned ON with a valid signal pre-set)
 - (a.) Press and hold the “Menu” key then press the “Power” key simultaneously, the “Lock/Unlock” menu will appear for 3 seconds.
 - (b.) Use the “Enter” key to select OSD or Power setting then set at “Unlock” by pushing the “UP” or “Down” button.
 - (c.) When the “UP” or “Down” button is released, the previous setting will be saved and exit the “Lock/Unlock” menu automatically.

Please note:

- a. When the OSD Lock function is selected, this indicates that all the buttons except “power” button are now disabled.
- b. When the Power Lock function is selected, this indicates that the power key is disabled; user can not to turn off the monitor by “Power” key.

On-Screen Display Menus

Main OSD Menu:

ITEM	CONTENT
Contrast	The monitor luminance level control.
Brightness	The monitor backlight level control.
Auto Adjust	Fine-tune the image to full screen automatically.
Left/Right	Moving screen image horizontal position to left or right.
Up/Down	Moving screen image vertical position to up or down.
Horizontal size	The screen image horizontal dot clock adjustment.
Fine	The screen image pixel phase adjustment.
OSD Left/Right	Moving OSD menu horizontal position to left or right.
OSD Up/Down	Moving OSD menu vertical position to up or down.
OSD Time out	OSD auto-disappear time selection.
OSD Language	OSD menu language selection. (English, French, Japanese, Deutsch, Spanish, Italian, Traditional Chinese and Simplified Chinese)
Factory Reset	Factory default value restored.
RGB	Color temperature selection. (9300K, 6500K, 5500K, 7500K, User)

Appendix

Troubleshooting

If you are experiencing trouble with the LCD display, refer to the following. If the problem persists, please contact your sales representative or our service center.

Problem: No image appears on screen.

- ▶ Check that all the I/O and power connectors are correctly and well connected described in the “Installation” section.
- ▶ Make sure the pins of the connectors are not crooked or broken.

Problem: Partial Image or incorrectly displayed image.

- ▶ Check to see if the resolution of your computer is higher than that of the LCD display.
- ▶ Reconfigure the resolution of your computer to make it less than or equal to 1280 x 1024.

Problem: Image has vertical flickering line bars.

- ▶ Use “Horizontal size” to make an adjustment.
- ▶ Check and reconfigure the display mode of the vertical refresh rate of your graphic card to make it compatible with the LCD display.

Problem: Image is unstable and flickering

- ▶ Use “FINE” to make an adjustment.

Problem: Image is scrolling

- ▶ Check and make sure the VGA signal cable (or adapter) is securely connected.
- ▶ Check and reconfigure the display mode of the vertical refresh rate of your graphics card to make it compatible with the LCD display.

Problem: Vague image (characters and graphics)

- ▶ Use “Horizontal size” to make an adjustment. If this problem still exists, use “FINE” to make an adjustment.

Warning Signal

If you see warning messages on your LCD screen, this means that the LCD display cannot receive a clean signal from the computer graphics card.

Below are the three kinds of Warning Signal. Please check the cable connections or contact your sales representative or our service center for more information.

No Signal

This message means that the LCD display has been powered on but it cannot receive any signal from the computer graphics card. Check all the power switches, power cables, and VGA signal cable.

Going to Sleep

The LCD display is under the power saving mode. In addition, the LCD display will enter power saving mode when experiencing a sudden signal disconnecting problem.

The monitor can be activated by pressing any keyboard, triggering the mouse or touching the screen.

Out of Range

This message means that the signal of the computer graphic card is not compatible with the LCD display. When the signal is not included in the "Video Modes" list we have listed in the Appendices of this manual, the LCD monitor will display this message.

Product Dimensions

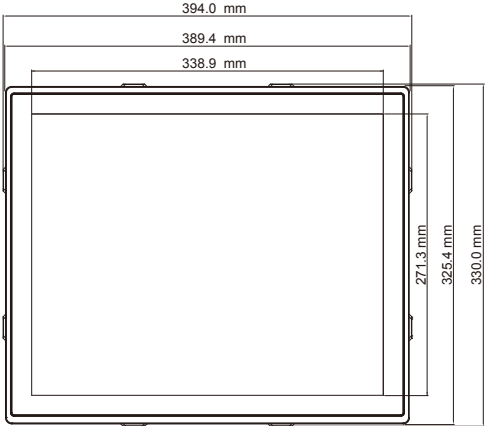

Front View

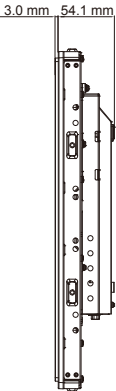

Side View

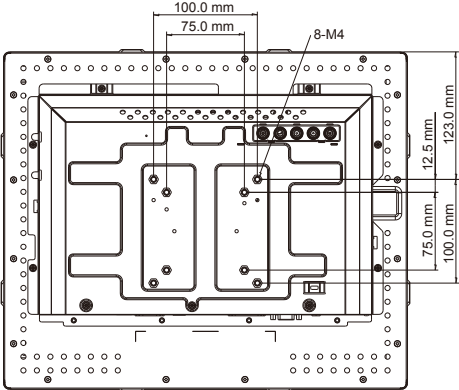

Back View

Compatibility Modes

Mode	Resolution	H-Frequency(khz)	V-Frequency(hz)
IBM VGA	720X400	31.47	70
IBM VGA	640X480	31.47	60
Apple MacII	640X480	35.00	66
VESA VGA	640X480	37.86	72
VESA VGA	640X480	37.50	75
VESA SVGA	800X600	35.16	56
VESA SVGA	800X600	37.88	60
VESA SVGA	800X600	48.08	72
VESA SVGA	800X600	46.88	75
Apple Mac	832X624	49.72	75
VESA XGA	1024X768	48.36	60
VESA XGA	1024X768	56.48	70
VESA XGA	1024X768	60.02	75
VESA SXGA	1280X1024	64.00	60
VESA SXGA	1280X1024	80.00	75
VESA SXGA	1152X864	67.50	75
VESA SXGA	1280X960	60.00	60

Touch Screen Driver Installation

The K17A Series is available with USB connection. Touch drivers can be downloaded at www.touchrev.com.

Please Note:

1. The K17A Series is Microsoft® Windows®HID (Human Interface Device) compatible if you use the USB touch screen interface. No additional software driver is required for general operation of the touch screen.
2. For K17A Series, the system requires 15 seconds for Windows 7 to install/uninstall the touch drivers while turning power on/off or plugging/unplugging USB cable.

K17A Series Calibration Instructions:

Calibrating the touch screen in Windows 7:

1. Tap the Start button, Control Panel and then Hardware and Sound.
2. Under Tablet PC Settings, tap Calibrate the screen for pen or touch input.
3. On the Display tab, under Display options, tap Calibrate and then Yes to allow the program to make changes.
4. Follow the on-screen instructions to calibrate the touch screen.