

1 2 3 4 5 6

A

B

C

D

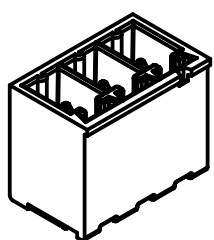
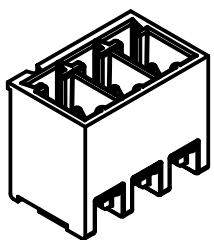
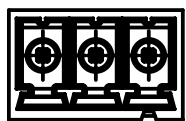
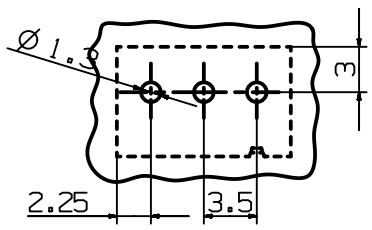
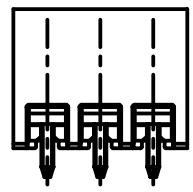
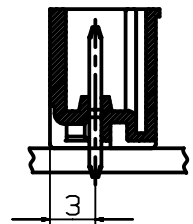
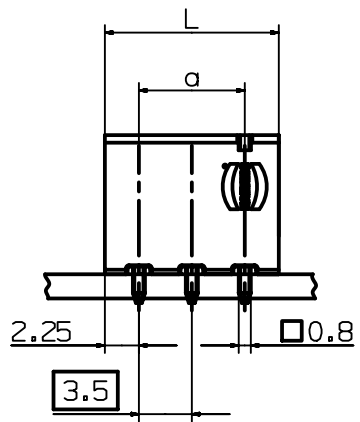
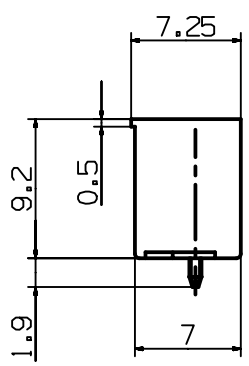

Poles	Dim. a	Dim. L
2	3.5	8
3	7	11.5
4	10.5	15
5	14	18.5
6	17.5	22
7	21	25.5
8	24.5	29
9	28	32.5
10	31.5	36
11	35	39.5
12	38.5	43
13	42	46.5
14	45.5	50
15	49	53.5
16	52.5	57
17	56	60.5
18	59.5	64
19	63	67.5
20	66.5	71
21	70	74.5
22	73.5	78
23	77	81.5
24	80.5	85
25	84	88.5

further information see: DS 141214-00201

	All rights reserved Department EC PD - DE	All Dimensions in mm Original Size DIN A4		Scale 2:1	Free size tol.	Ref. Sub. TB 1412XX14-001000, Rev. A, 18.04.2013, 500000058430	
		Created by TADJE	Inspected by DAHMS	Standardisation HOFFMANN	Date 2013-08-19	State Approved	
HARTING Electronics GmbH D-32339 Espelkamp		Title har-flexicon 3.50 MTV-xx BX BK				Doc-Key / ECM-Nr. 100529102/UGD/001/B 500000065415	
		Type TB	Number 1412XX14-001XXX			Rev. B	Page 1/1