

Peak Emission Wavelength: 950nm

The MTE9460C2 consists of a 950nm high output infrared die in a water-clear 3mm flat top plastic molded package. Custom package solutions and sorting are available..

FEATURES

- > High Output Power
- > High Reliability
- > Compact
- > Wide Beam Angle

APPLICATIONS

- > Optical Switches
- > Optical Sensors
- > Fiber Optical Communication



Absolute Maximum Ratings (Ta=25°C)



ITEMS	SYMBOL	RATINGS	UNIT
Forward Current	IF	100	mA
Forward Current (Pulse)*1	IFP	1	A
Reverse Voltage	VR	5	V
Power Dissipation	PD	190	mW
Operating Temperature Range	Topr	-20 ~ +85	°C
Storage Temperature Range	Tstg	-30 ~ +100	°C
Junction Temperature	Tj	100	°C
Lead Soldering Temperature*2	Tls	260	°C

*1: Tw=10μsec, T=10msec; *2: Time 5 Sec max, Position: Up to 3mm from the body.

Electrical & Optical Characteristics (Ta = 25°C)

ITEMS	SYMBOL	CONDITIONS	MIN	TYP	MAX	UNIT
Power Output	PO	IF=50mA	--	23	--	mW
Forward Voltage	VF	IF=50mA	--	1.30	1.90	V
Reverse Current	IR	VR=5V	--	--	10	μA
Peak Emission Wavelength	λp	IF=50mA	--	950	--	nm
Spectral Line Half Width	Δλ	IF=50mA	--	40	--	nm
Half Intensity Beam Angle	Θ	IF=50mA	--	±60	--	deg

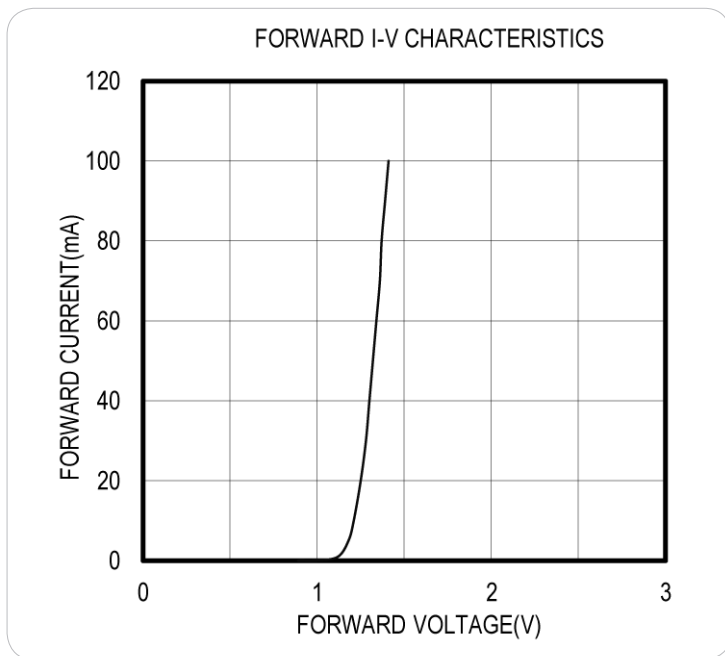
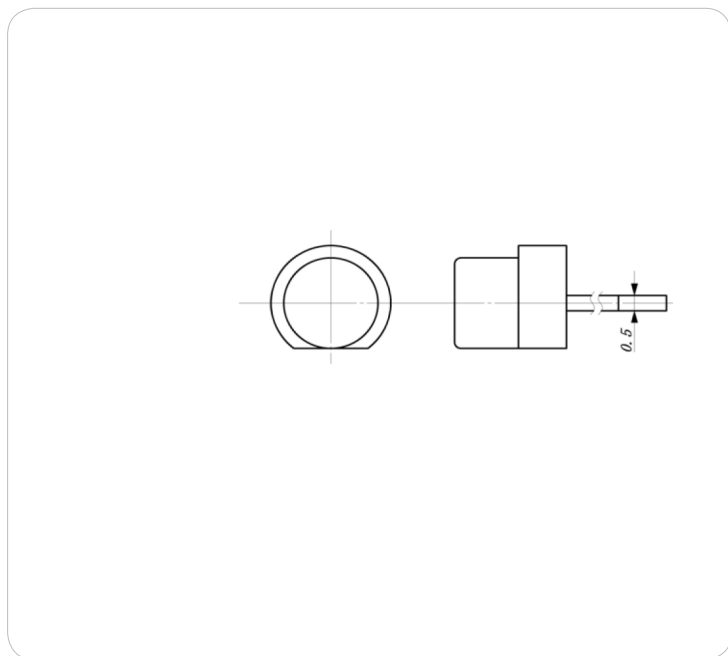
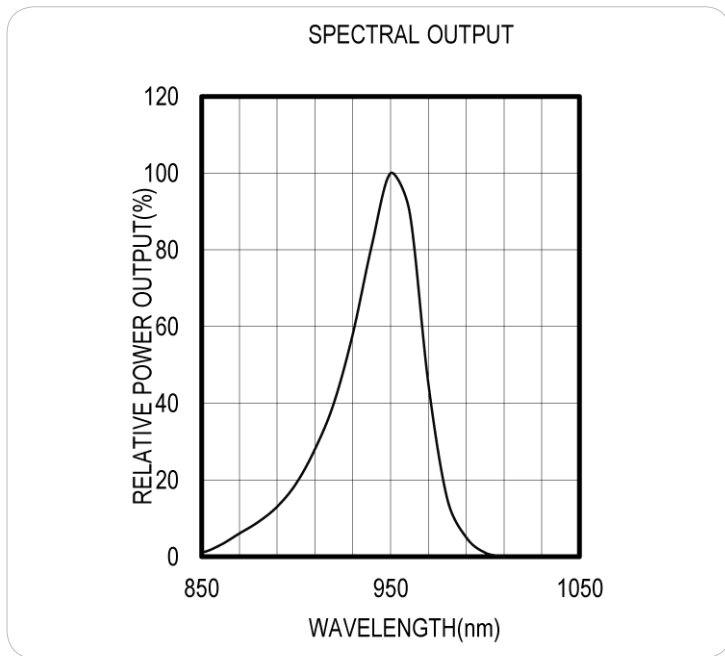
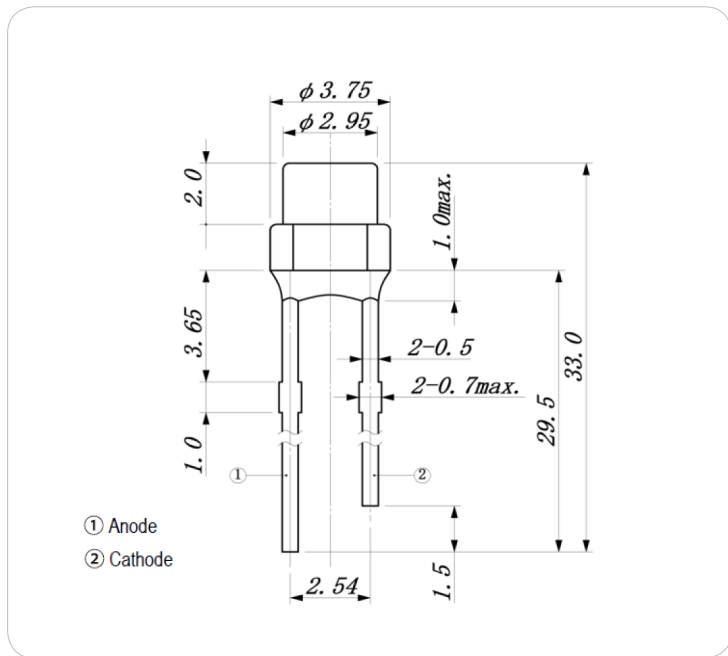

Unit: mm, Tolerance: ± 0.2

2013-05-07

RELATIVE POWER vs FORWARD CURRENT

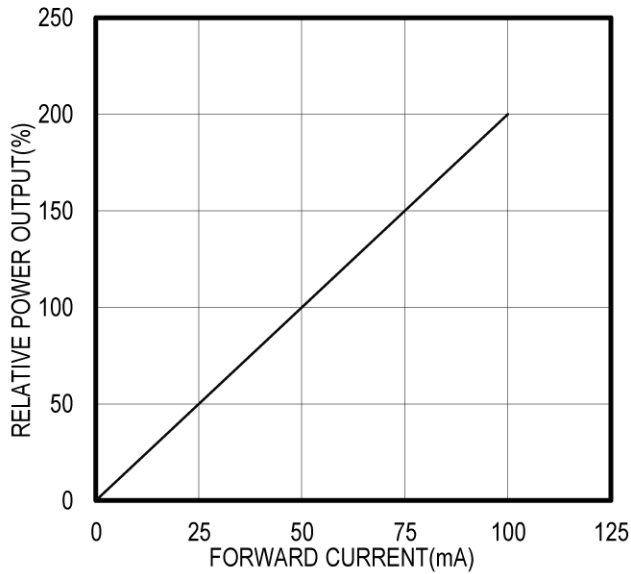

THERMAL DERATING CURVE

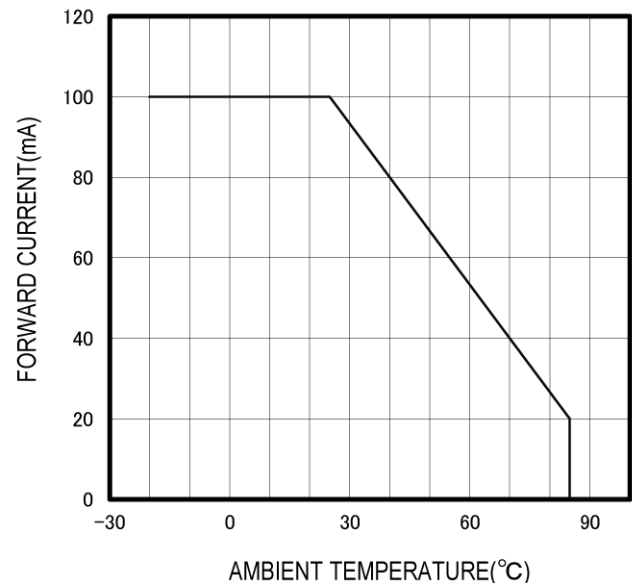

RADIATION PATTERN

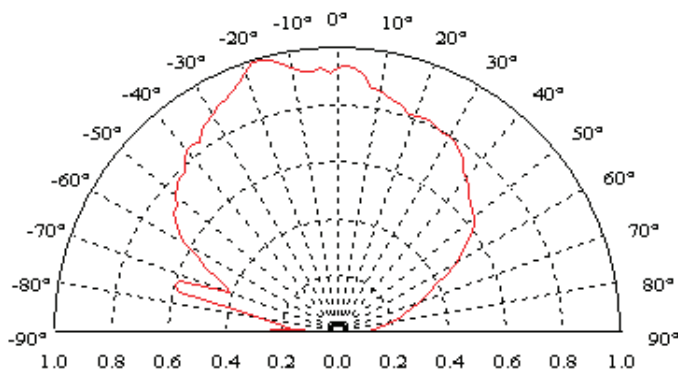

The information contained herein is subject to change without notice.

2013-05-07