

DETAILS

Product Number	F14563_JENNY-T4
Family	Jenny
Type	Lens
Color	clear
Diameter	35 + 35 mm
Height	17,02 mm
Style	rectang
Optic Material	Silicone
Holder Material	
Fastening	pin, glue
Status	production ready
ROHS Compliant	Yes
Date Updated	6/04/2016



OPTICAL PROPERTIES

LED	Viewing Angle	Light Beam	Efficiency	cd/lm	Connector
V10 Gen6	asymmetric deg	Streetligh...	93 %	0.460	-
V10 Gen7	sim: Asymmetric	Streetligh...	sim: 94 %	sim: 0.440	-
CLL02x/CLU02x (LES10)	asymmetric deg	Streetligh...	93 %	0.460	-
CXA/B 15xx	Asymmetric deg	Streetligh...	94 %	0.480	-
XM-L EZW	asymmetric deg	Streetligh...	93 %	0.680	-
MK-R	asymmetric deg	Streetligh...	93 %	0.560	-
MX-6	asymmetric deg	Streetligh...	92 %	0.610	-
XHP70	asymmetric deg	Streetligh...	91 %	0.500	-
LUXEON M/MX	asymmetric deg	Streetligh...	94 %	0.660	-
CXM-9	asymmetric deg	Streetligh...	93 %	0.460	-
Soleroiq P9	asymmetric deg	Streetligh...	94 %	0.470	-
Duris P10	sim: Asymmetric	Streetligh...	sim: 92 %	sim: 0.550	-
COB D Series LES 9.8 mm	asym deg	Streetligh...	94 %	0.470	-
MJT COB LES 9.8	Asymmetric deg	Streetligh...	94 %	0.470	-
MJT COB LES 6	Asymmetric deg	Streetligh...	92 %	0.540	-
SLE G5 LES6	Asymmetric deg	Streetligh...	93 %	0.600	-
SLE G5 LES11	Asymmetric deg	Streetligh...	92 %	0.460	-

LED location in part center

Bottom view

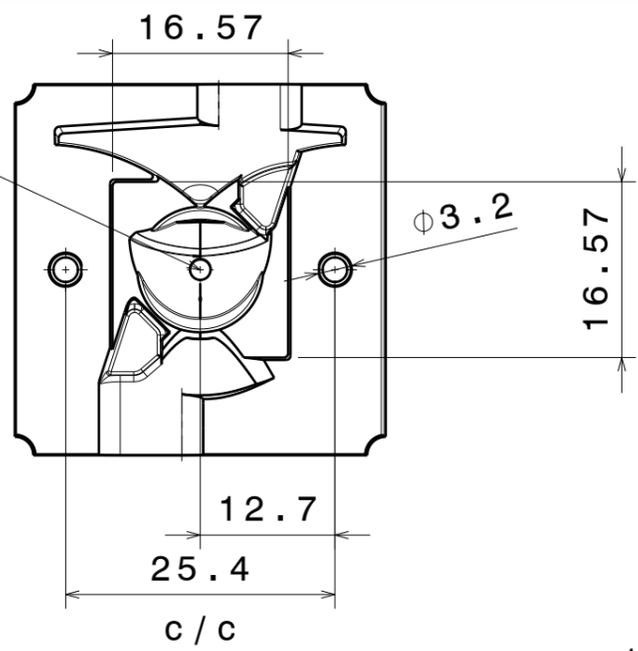

Front view

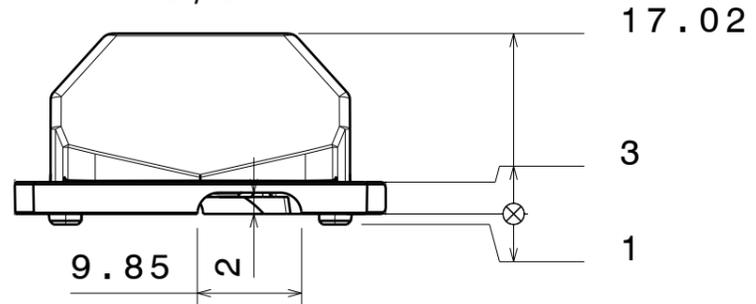

Asymmetric light direction shown by arrow

Top view

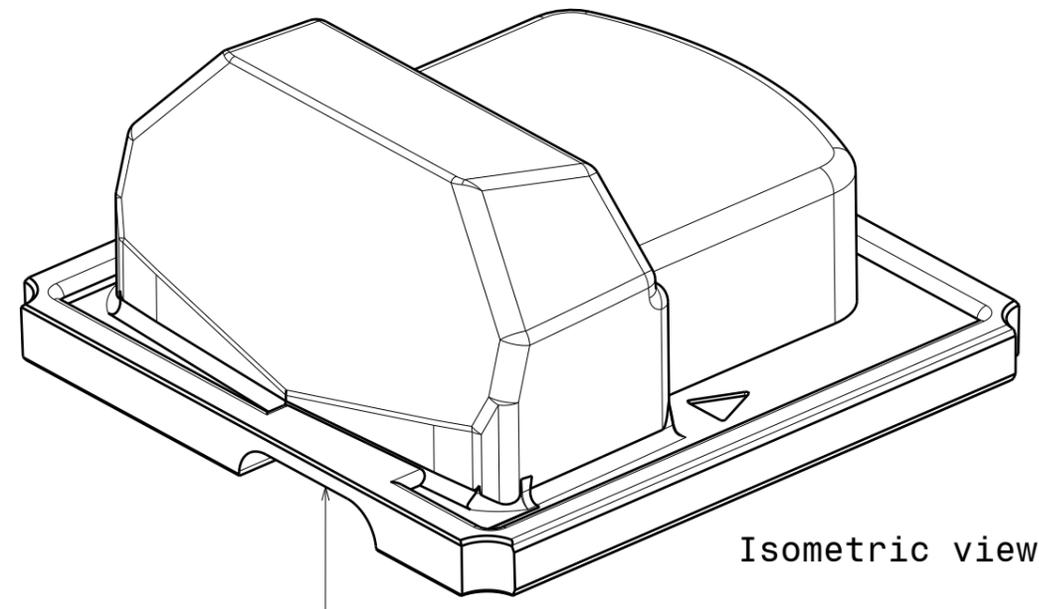
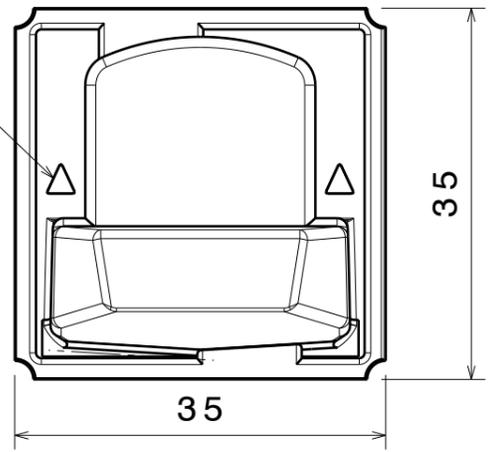

Isometric view

Wire outlet both sides

When thermal adhesive tape is used, recommended tape thickness up to 0.3mm. When assembling led ensure correct position in relation to lens position pin hole.

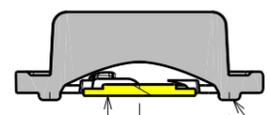

Position pin

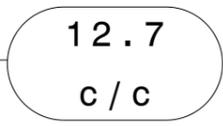

Section view B-B
Scale: 1:1

INDEX	PART NO	DESCRIPTION	MATERIAL	COLOUR
1	F14563	JENNY-T4	Optical grade silicon	

Tolerances if not otherwise shown
According to DIN ISO 2768-1
Linear measures: class V
Please note that due to the elasticity of products made of silicone actual measured values may vary, and therefore typical tolerance values may not be applied.

LEDiL LediL Oy
Salorankatu 10
FIN 24240 SALO
Finland

THIRD ANGLE PROJECTION:

DRAWING TITLE
F14563_JENNY-T4

This drawing is the property of LEDiL Oy. It may not be reproduced, copied or communicated without a written agreement with LEDiL Oy.

SIZE	PART NUMBER
A3	F14563

SCALE	1:1	WEIGHT		SHEET	1/1
-------	-----	--------	--	-------	-----

Luminaire: LEDiL Oy F14563_JENNY-T4_(V10)

Lamps: 1 x Bridgelux_V10_(BXRE-30E1000B-X2)_762.297lm@250mA_P=6.31095W_I=0.2498A

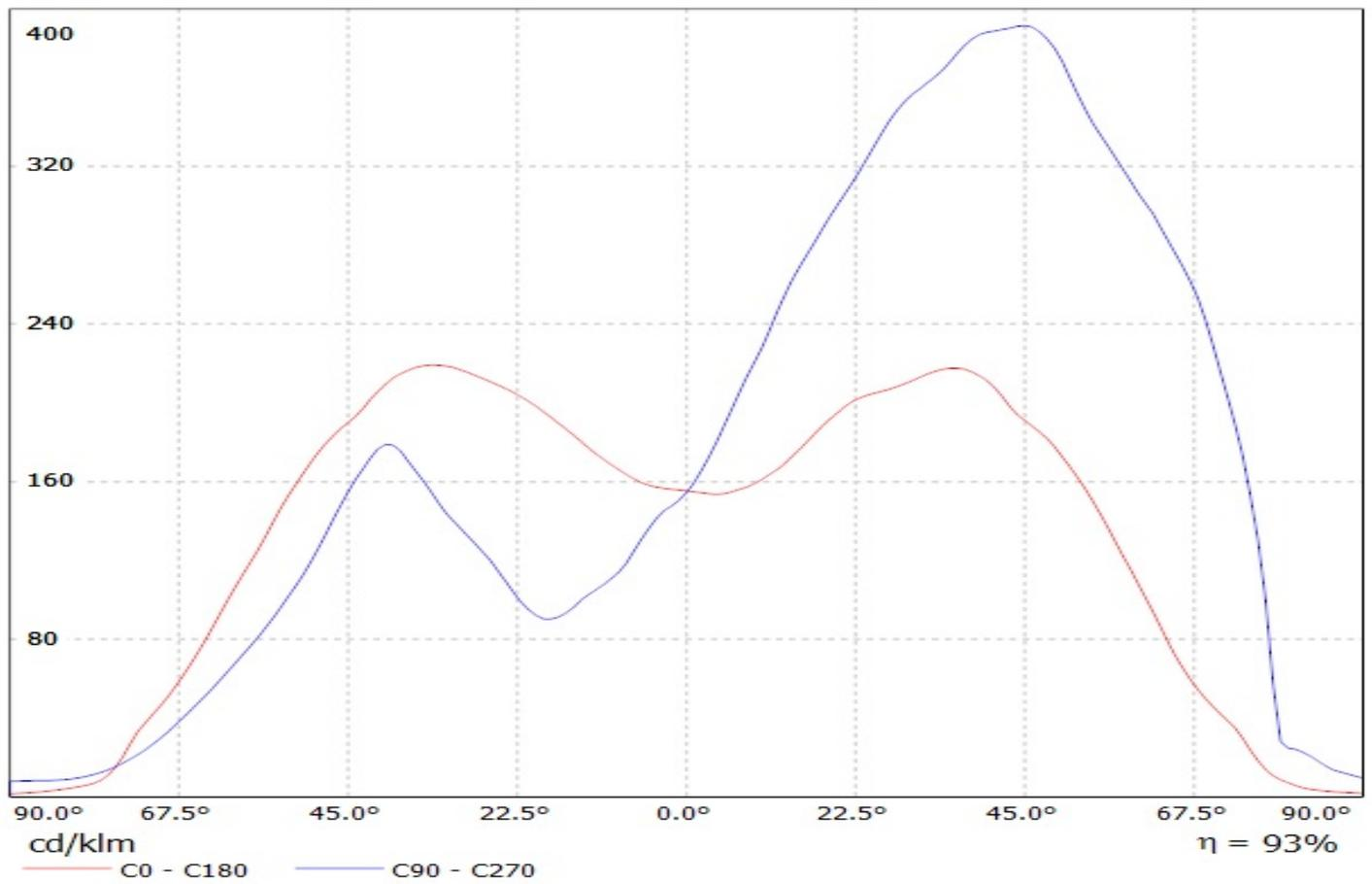

Luminaire: Ledil Oy F14563_JENNY-T4_BRIDGELUX_V10_Gen7_SIMULATED
Lamps: 1 x BRIDGELUX V10 Gen7

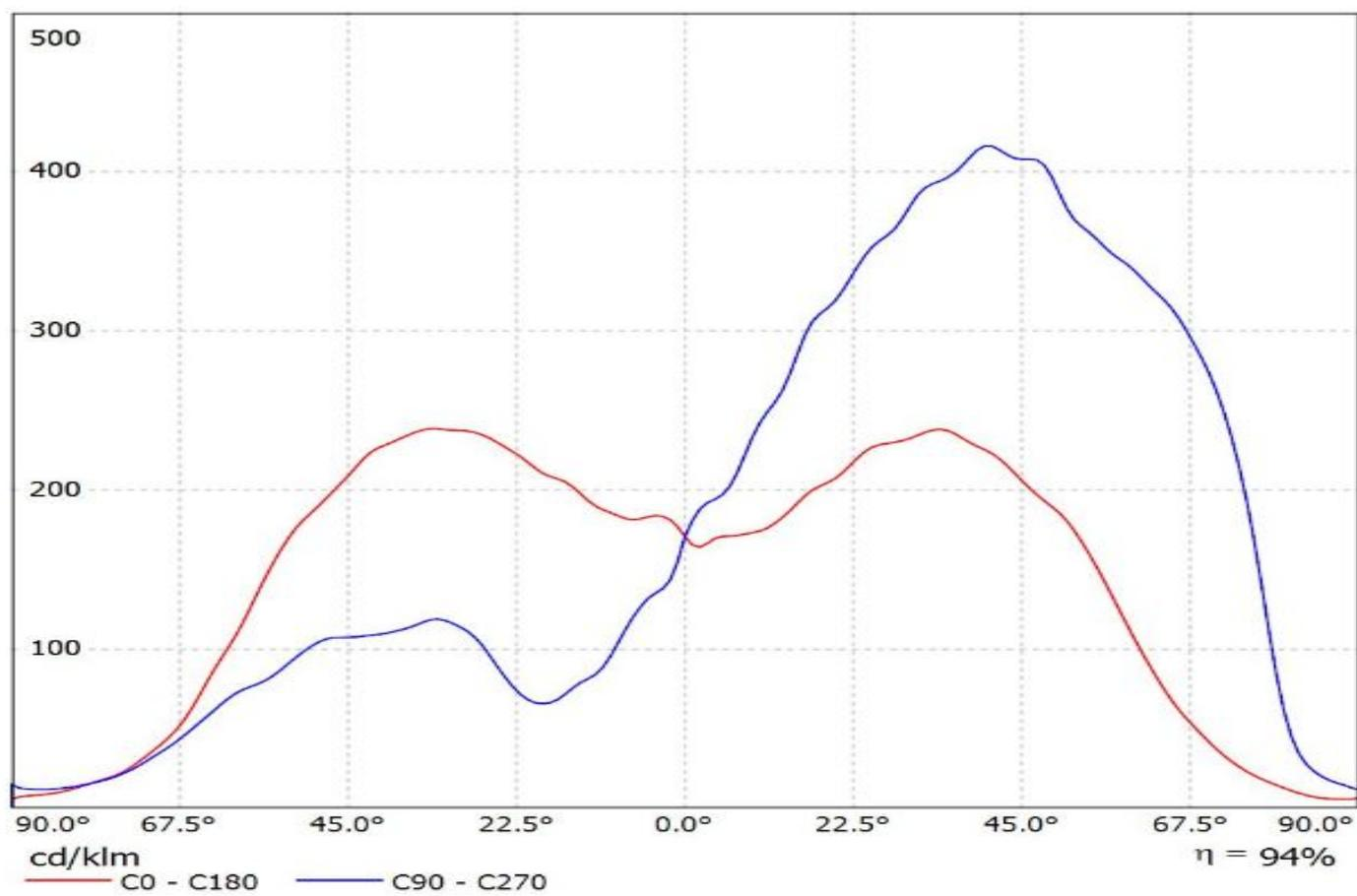

LEDiL Oy F14563_JENNY-T4_(CLU024) / LDC (Linear)

Luminaire: LEDiL Oy F14563_JENNY-T4_(CLU024)
Lamps: 1 x Citizen_CLU024_(CLU024-1204B8-303M1A2)
_935.254lm@250mA_CCT=3247K_P=8.32392W_I=0.2499A

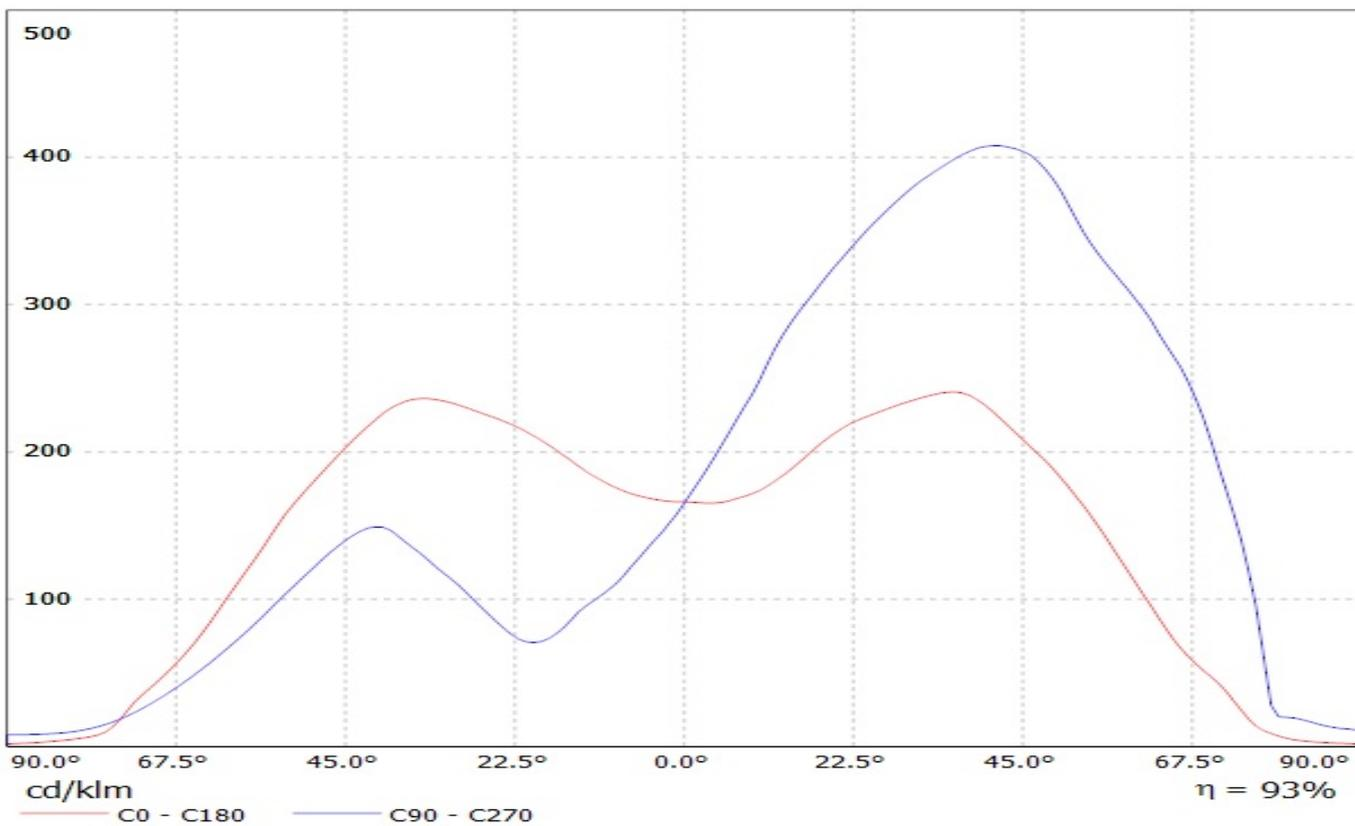

Ledil F14563_JENNY-T4_(CXA1520) / LDC (Linear)

Luminaire: Ledil F14563_JENNY-T4_(CXA1520)

Lamps: 1 x CREE_CXA1520_(-30F-N4-N0H-0001)_1029.79lm@250mA_CCT=3094K_P=8.46W_I=0.25A

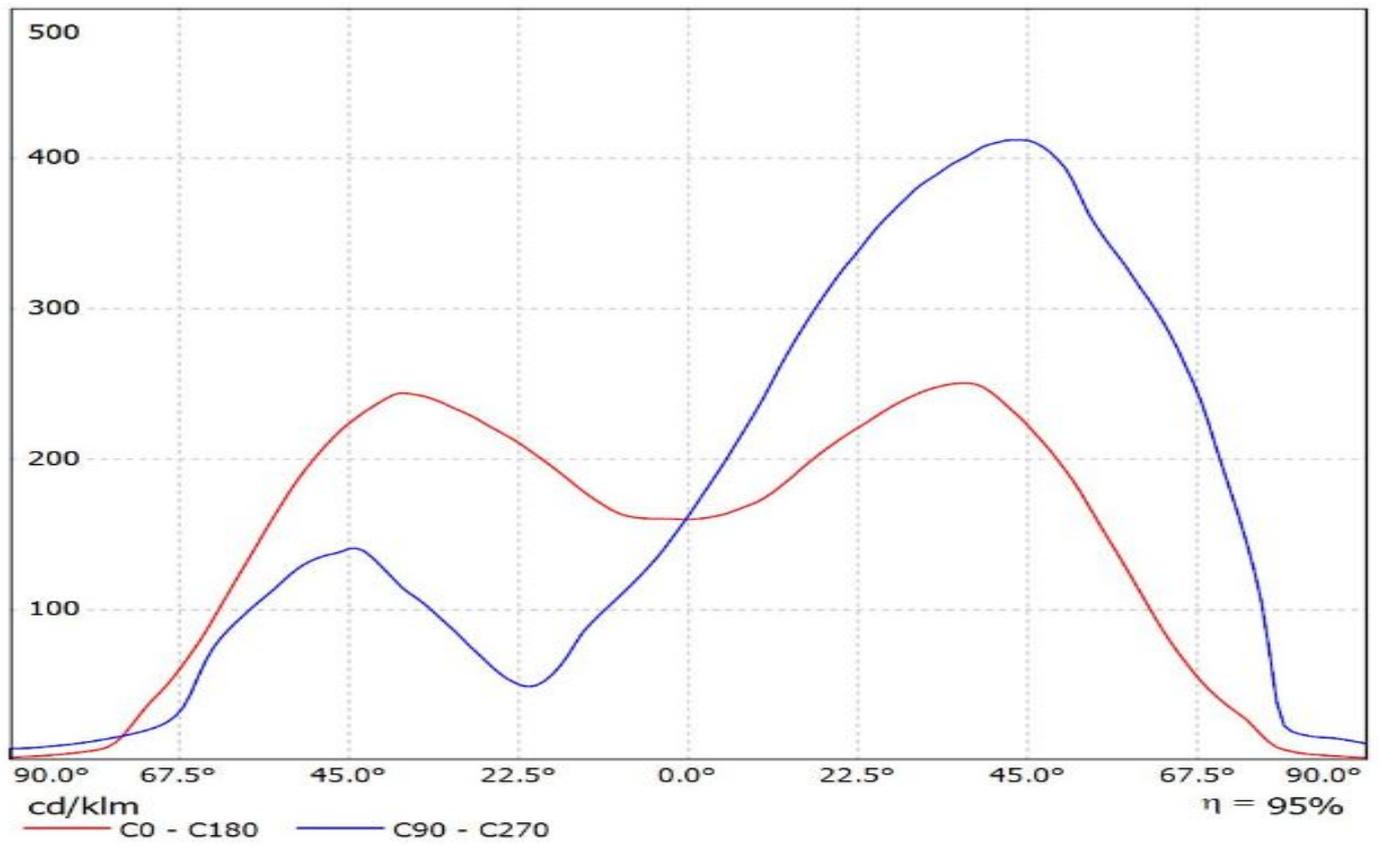

Luminaire: Ledil F14563_JENNY-T4_(Cree_XML_EZW)
Lamps: 1 x Cree_XML_EZW_133.676lm@250mA_P1.5=W_I=0.250A

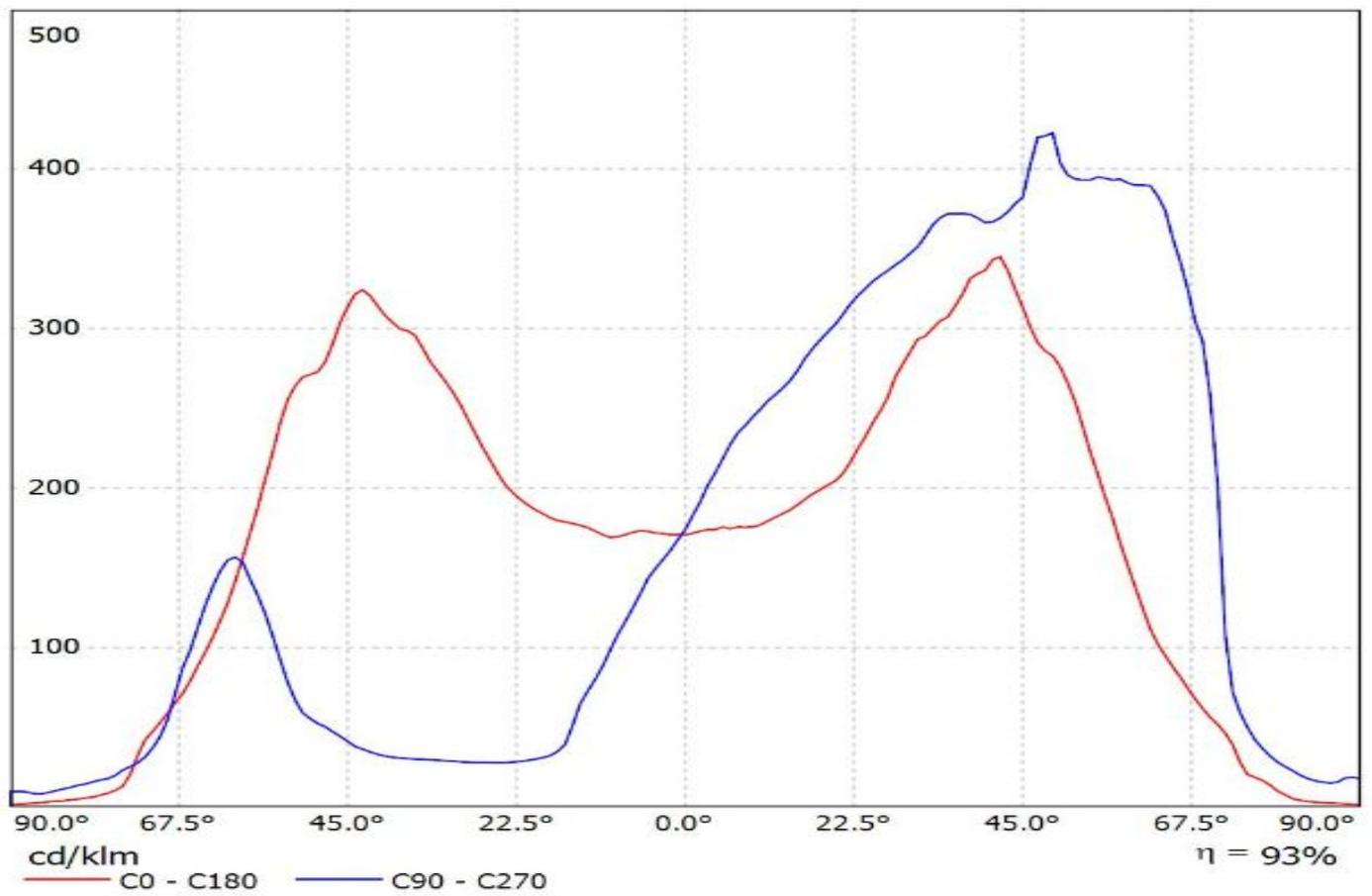

Luminaire: Ledil F14563_JENNY-T4_(Cree_MK-R)
Lamps: 1 x Cree_MK-R_197.7lm@250mA_P=1.42W_I=0.250A

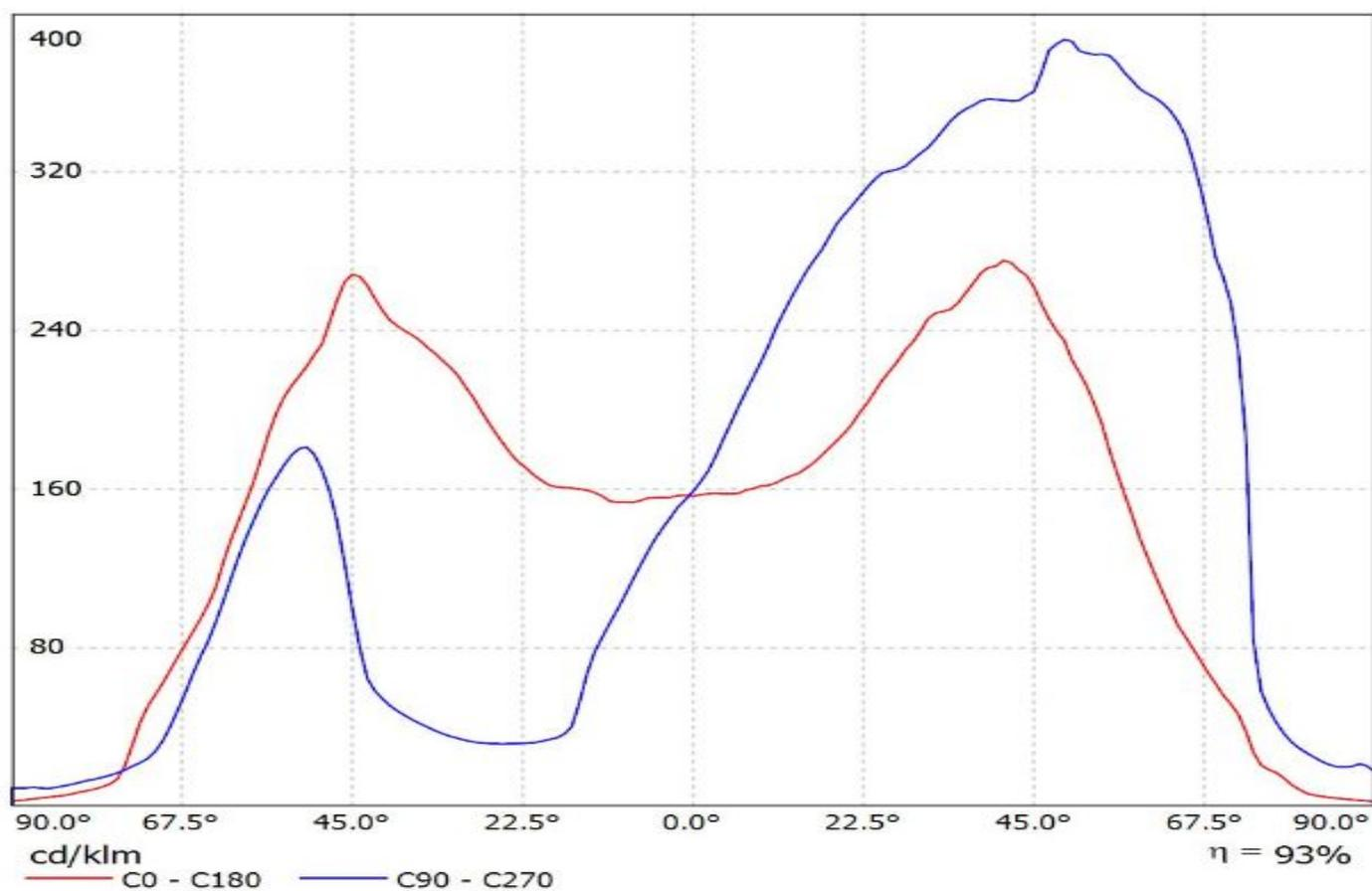

Luminaire: Ledil F14563_JENNY-T4_(Cree_MX-6)
Lamps: 1 x Cree_MX-6_65.8lm@250mA_P0.86=W_I=0.250A

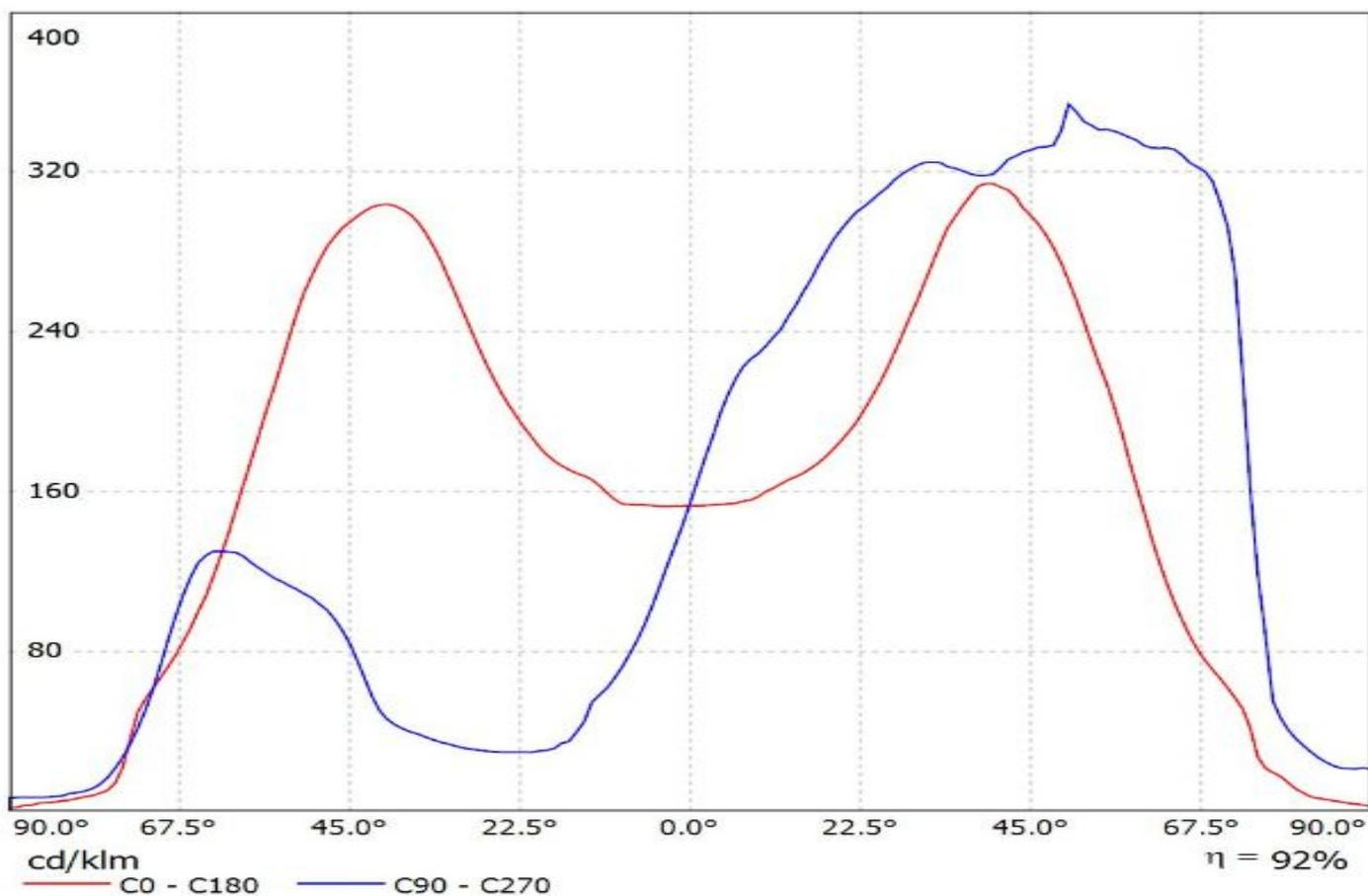

Luminaire: Ledil F14563_JENNY-T4_(Cree_XHP-70)
Lamps: 1 x Cree_XHP-70_Im@250mA_P=W_I=0.250A

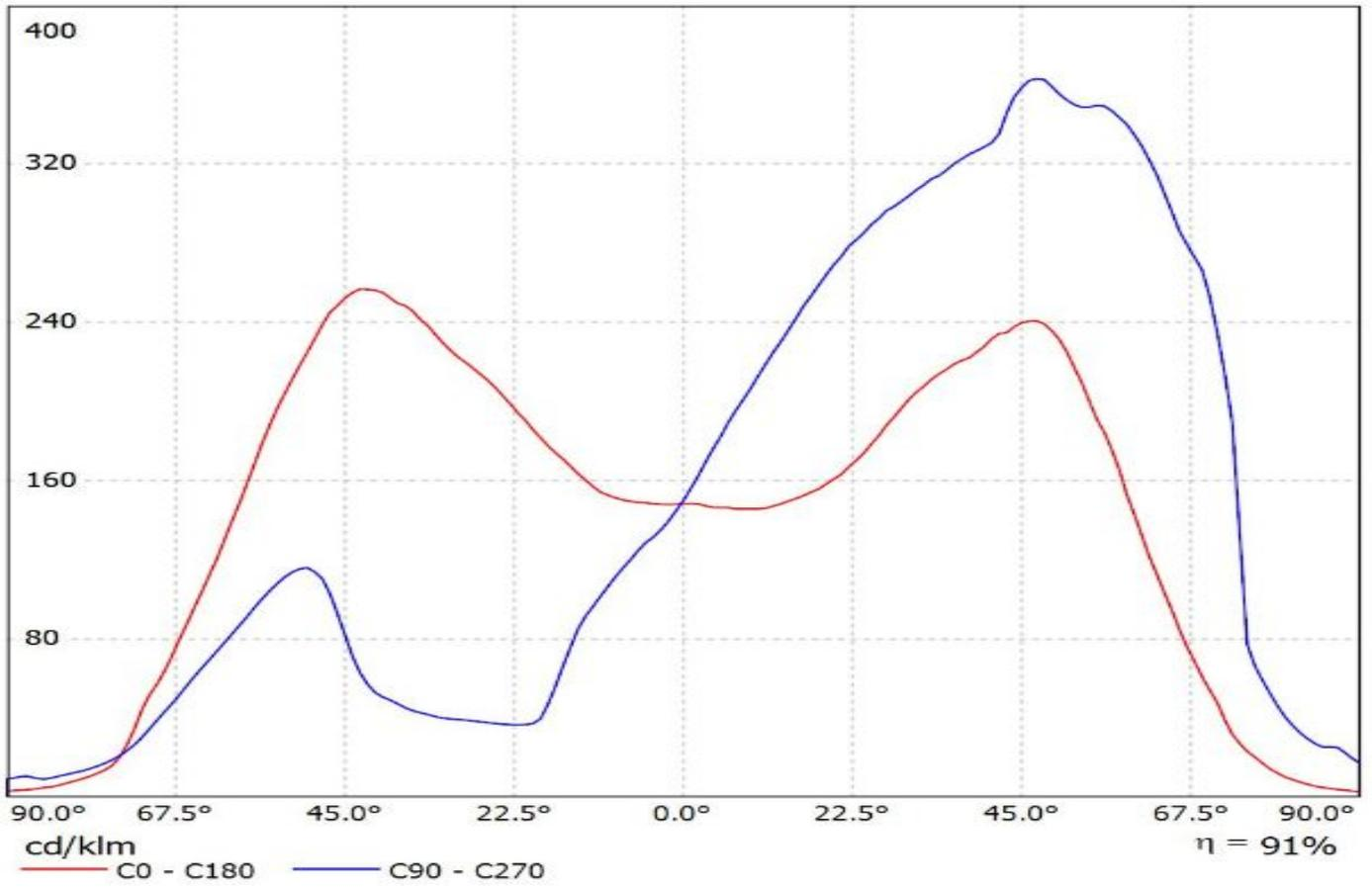

Luminaire: LEDiL Oy F14563_JENNY-T4_(Luxeon_M)

Lamps: 1 x Luxeon_M_(LXR8-SW30)_346.517lm@250mA_P=2.78838W_η=0.2499A

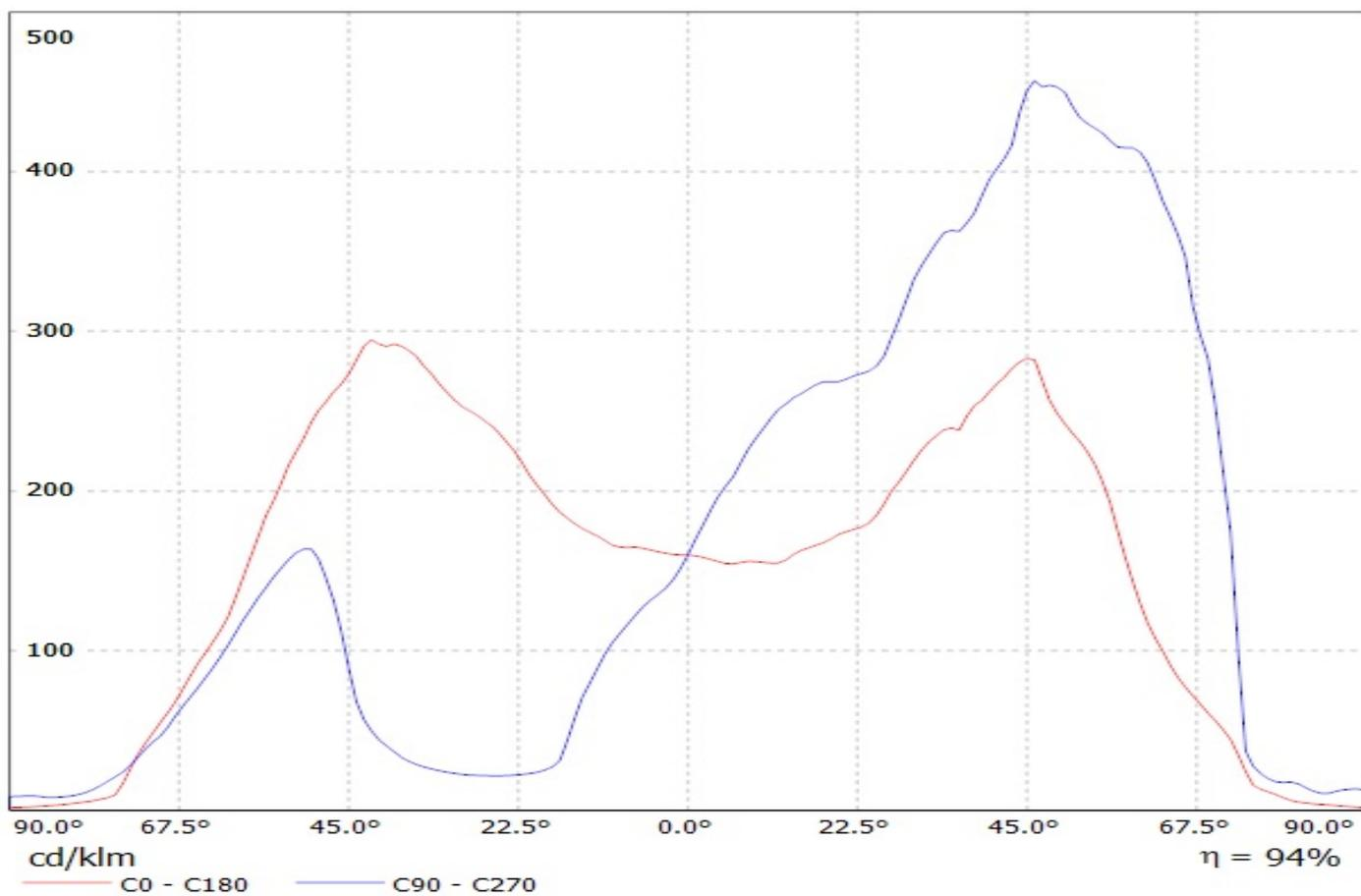

Luminaire: LEDiL Oy F14563_JENNY-T4_(CXM-9)

Lamps: 1 x Luminus_XNOVA_CXM-9_960.72lm@240mA_P=8.2476W_I=0.24A

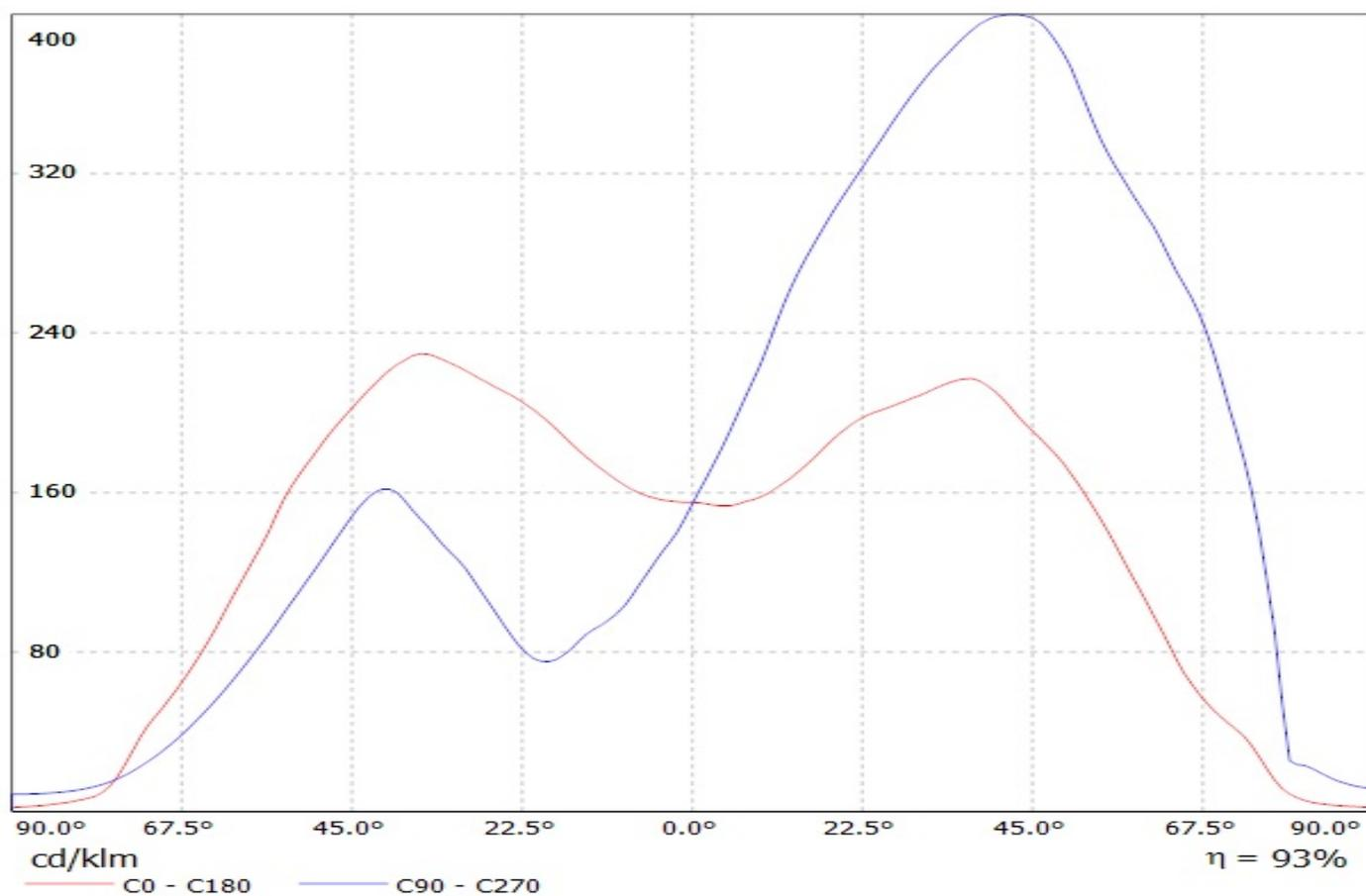

Luminaire: Ledil F14563_JENNY-T4_(Soleriq_P9)

Lamps: 1 x Soleriq_P9_919.903lm@250mA_CCT=4372K_P=6.9W_I=0.250A

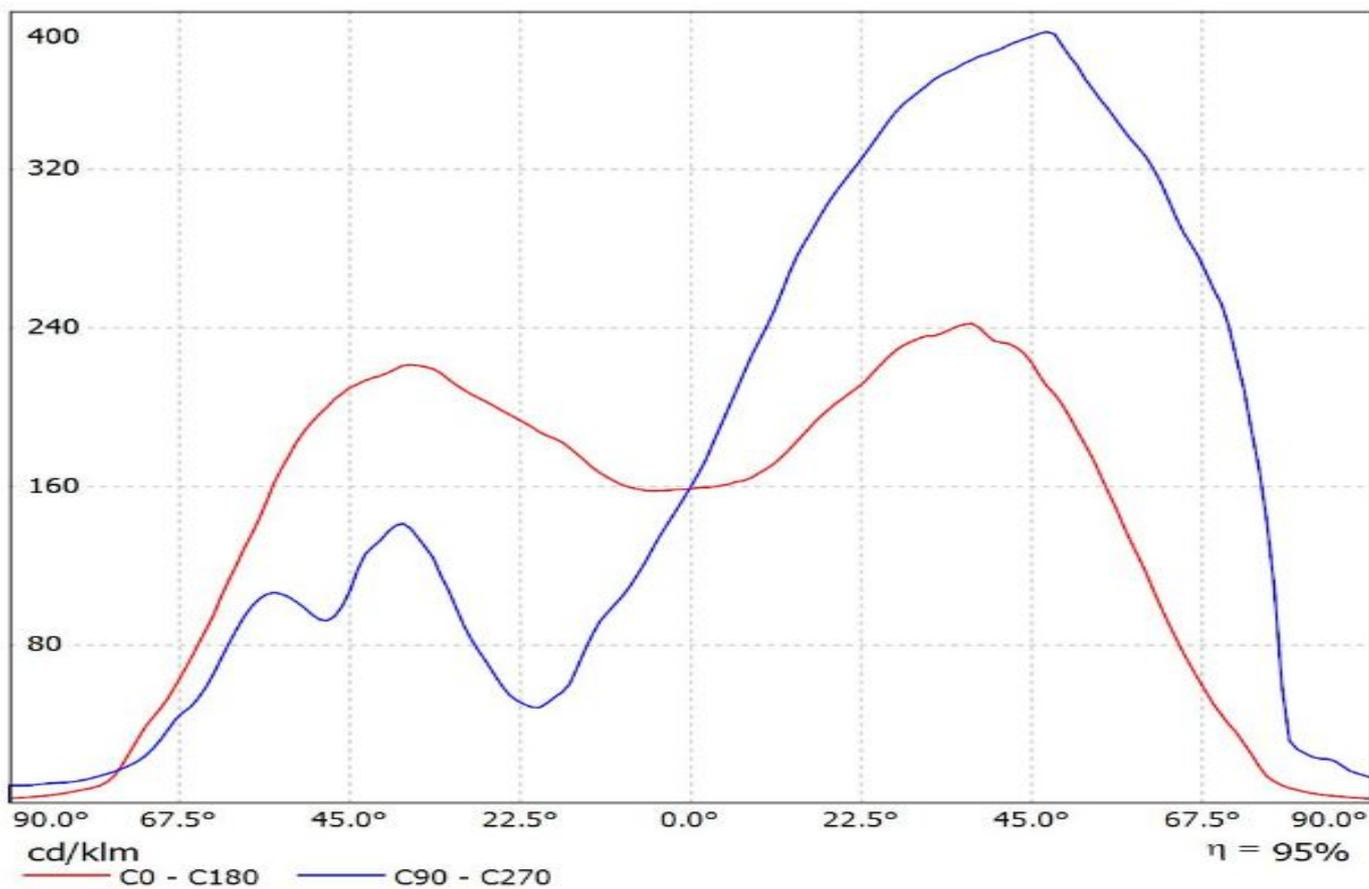

Luminaire: LEDiL Oy FCN14875_JENNY-T4_(COB_D_LES_9.8mm)
Lamps: 1 x Samsung_COB_D_series_LES_9.8mm_LC013D_534.999lm@100mA_P=3.1948W_I=0.100A

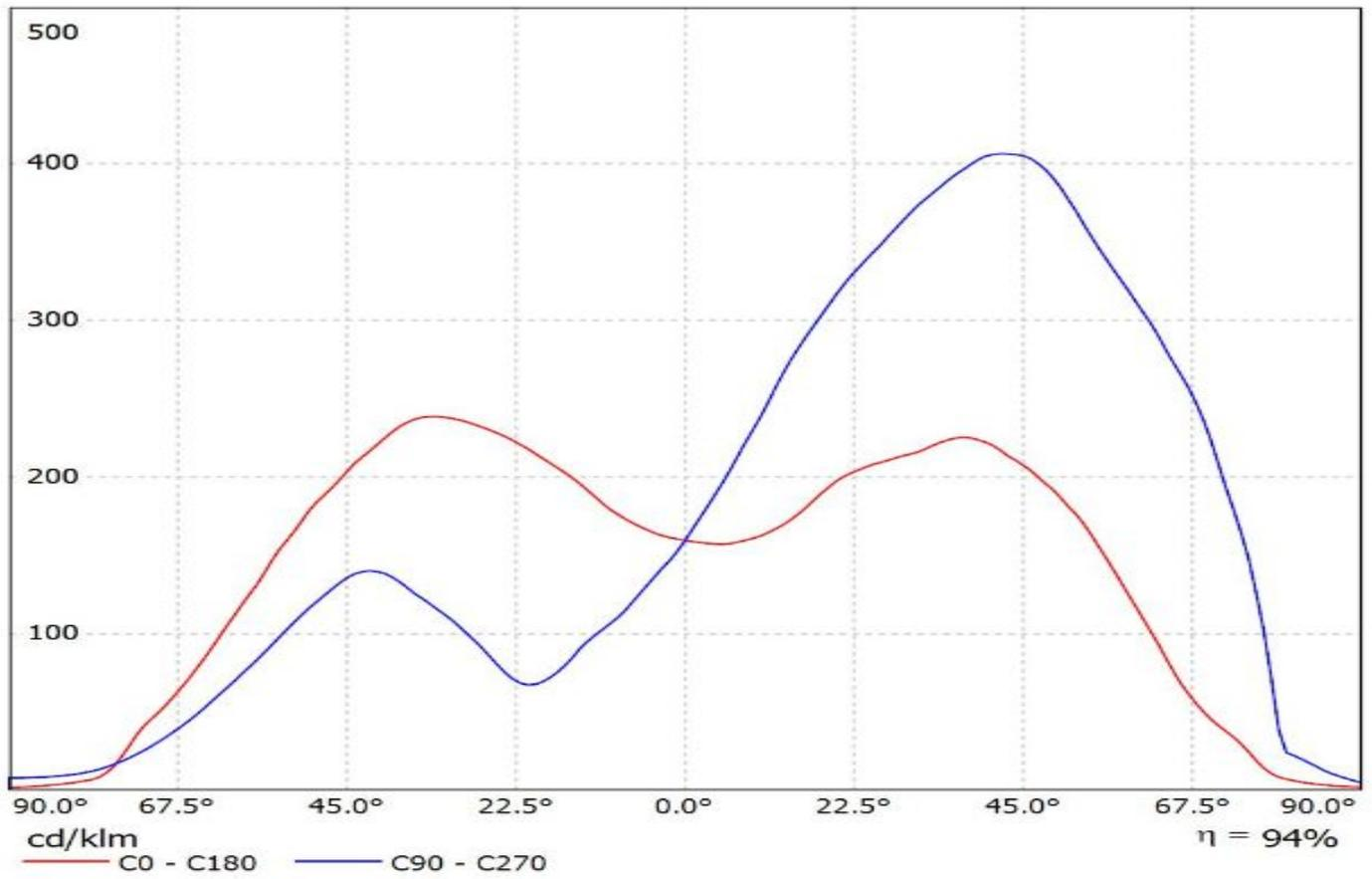

Luminaire: Ledil F14563_JENNY-T4_(MJT_12W_Les9,8)

Lamps: 1 x Seoul_MJT_12W_Les9.8mm_(SAWx1063A)_1245.58lm@250mA_P=8.30025W_I=0.25A

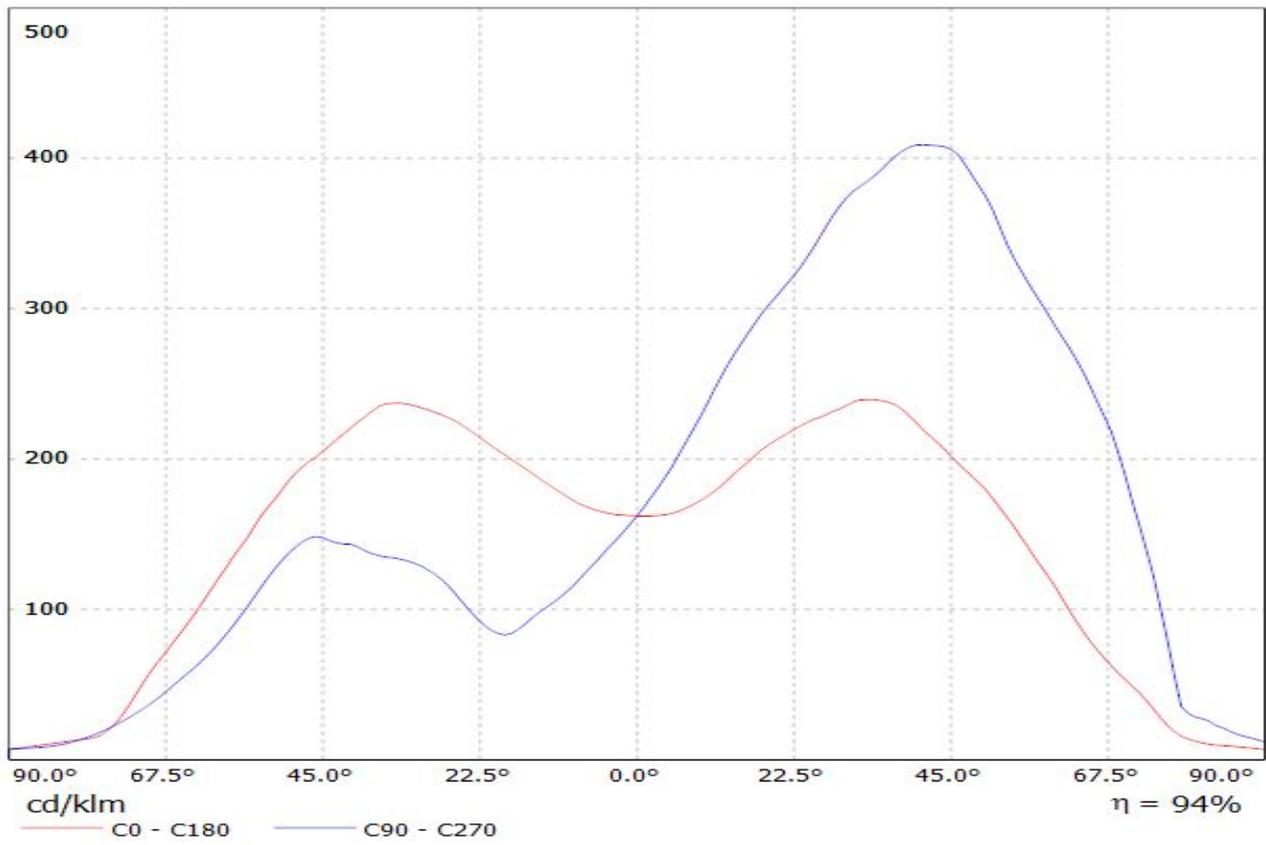

Luminaire: Ledil F14563_JENNY-T4_(MJT_6W_Les6)

Lamps: 1 x Seoul_MJT_6W_Les6mm_(SAWx0661A)_820.711lm@180mA_P=6.3909W_I=0.18A

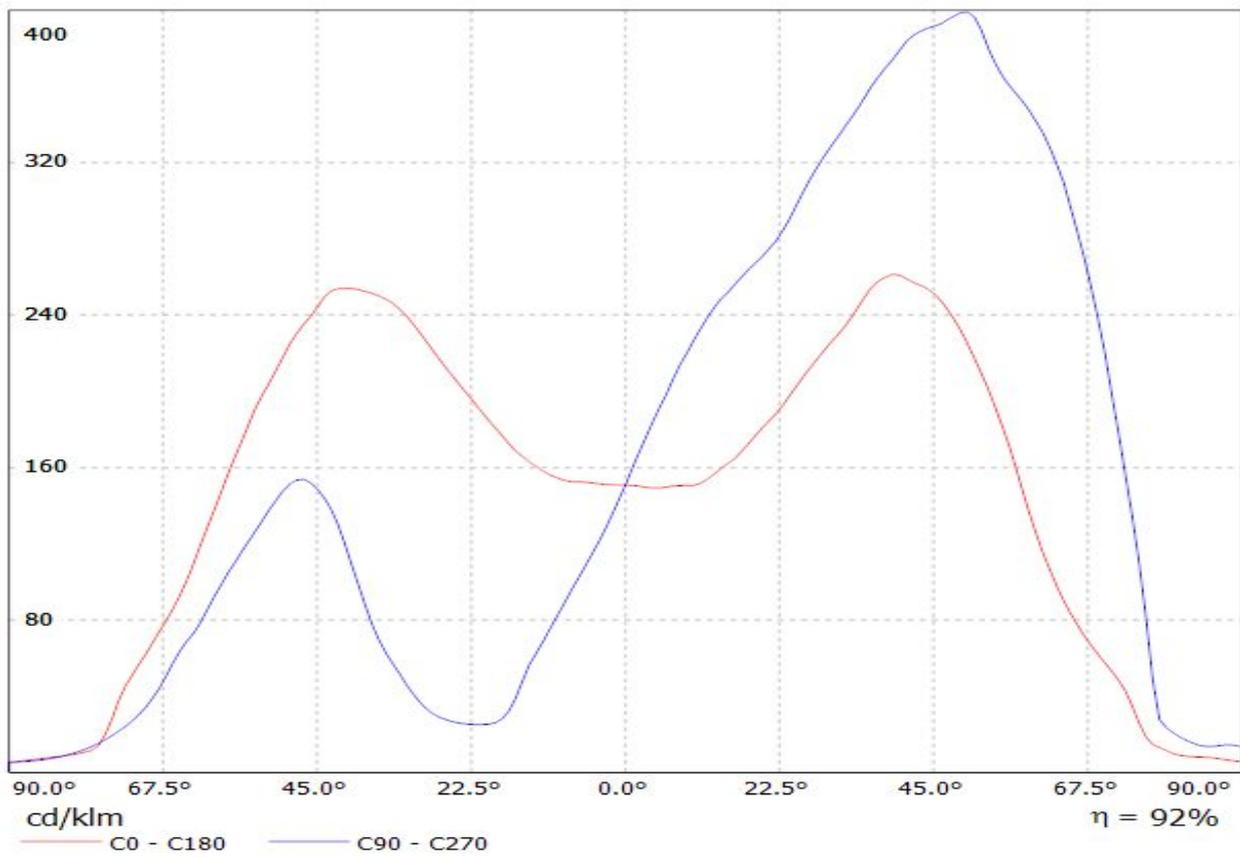

Luminaire: LEDiL Oy F14563_JENNY-T4_(SLE-G5_LES-6)
Lamps: 1 x Tridonic_SLE-G5_LES-6_470.842lm@100mA_P=3.3743W_I=0.100A

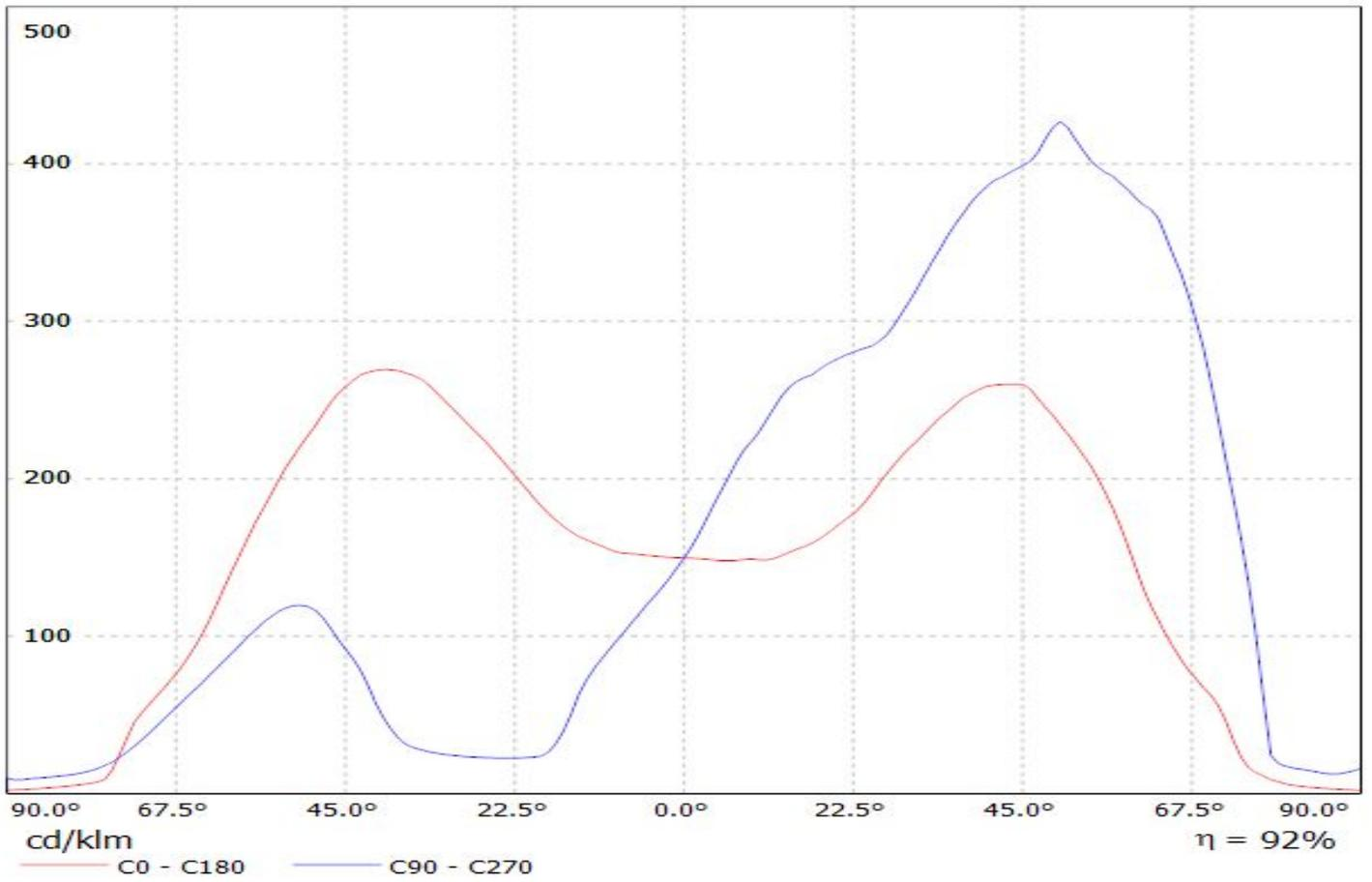

Luminaire: LEDiL Oy F14563_JENNY-T4_(SLE-G5_LES-11)
Lamps: 1 x Tridonic_SLE-G5_LES-11_1179.13lm@250mA_P=8.3433W_I=0.250A

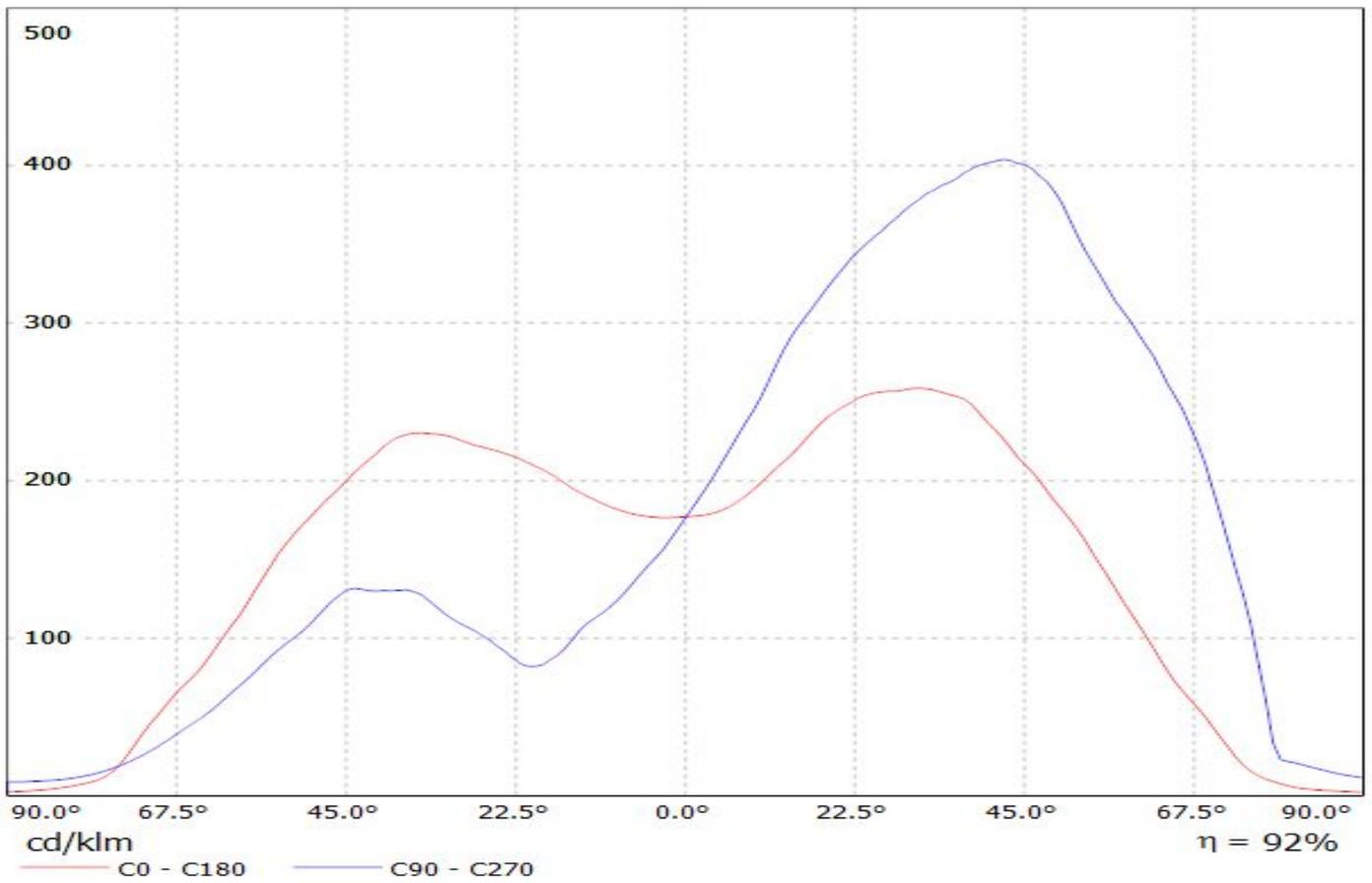

Luminaire: LEDiL Oy F14563_JENNY-T4_(V10)

Lamps: 1 x Bridgelux_V10_(BXRE-30E1000B-X2)_762.297lm@250mA_P=6.31095W_I=0.2498A

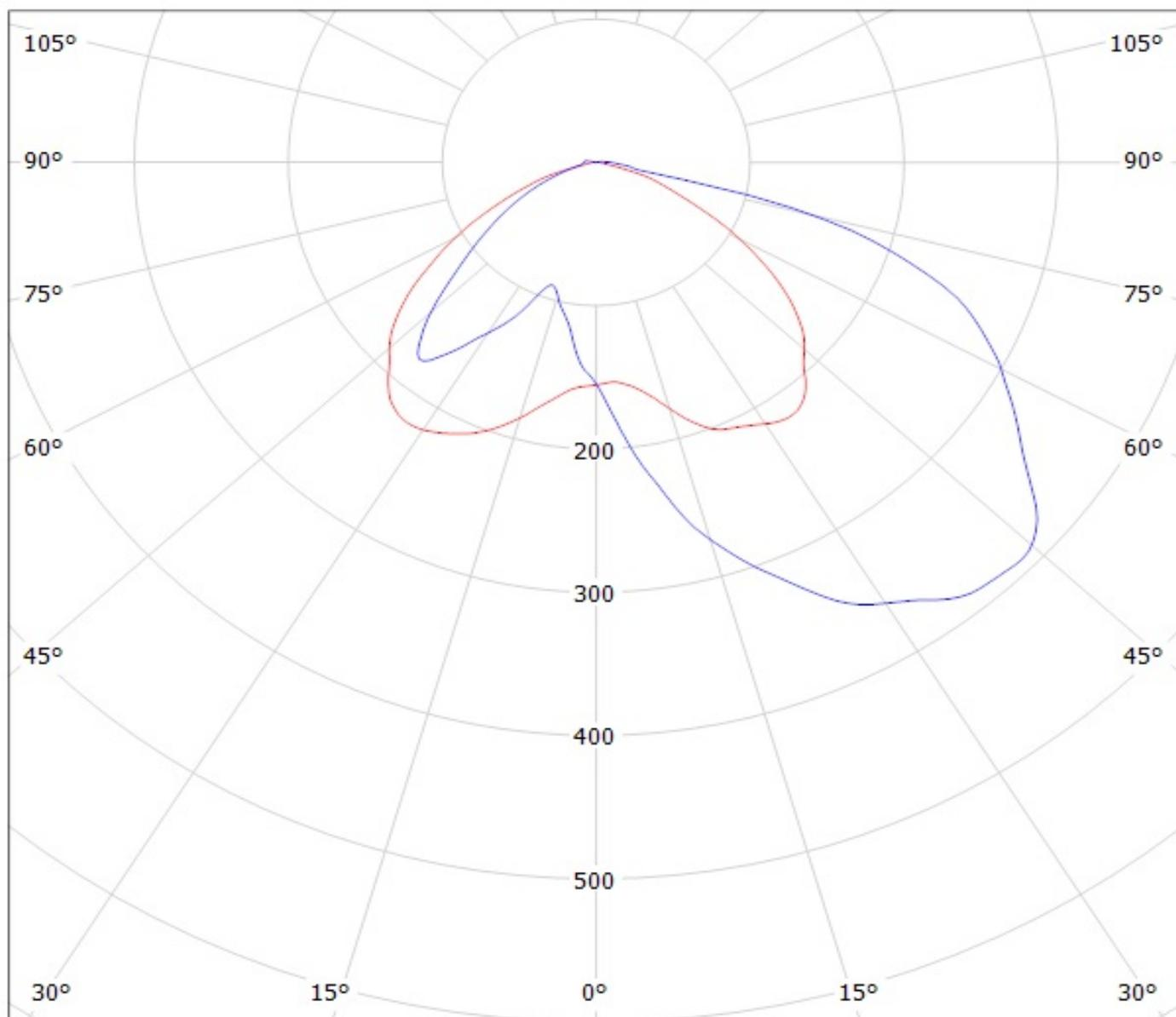

cd/klm

$\eta = 93\%$

— C0 - C180

— C90 - C270

Luminaire: Ledil Oy F14563_JENNY-T4_BRIDGELUX_V10_Gen7_SIMULATED
Lamps: 1 x BRIDGELUX V10 Gen7

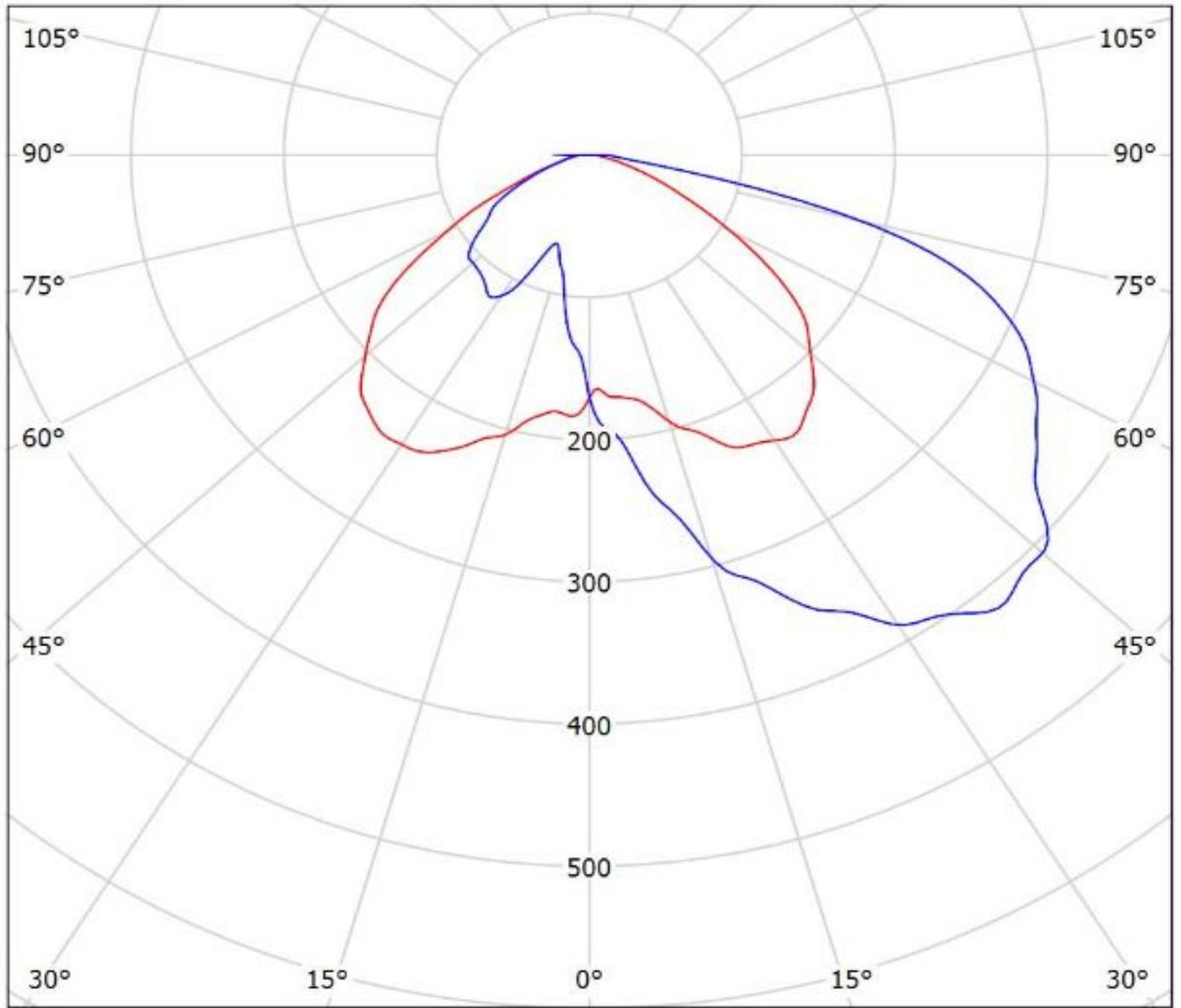

cd/klm
— C0 - C180 — C90 - C270

$\eta = 94\%$

LEDiL Oy F14563_JENNY-T4_(CLU024) / LDC (Polar)

Luminaire: LEDiL Oy F14563_JENNY-T4_(CLU024)
Lamps: 1 x Citizen_CLU024_(CLU024-1204B8-303M1A2)
_935.254lm@250mA_CCT=3247K_P=8.32392W_I=0.2499A

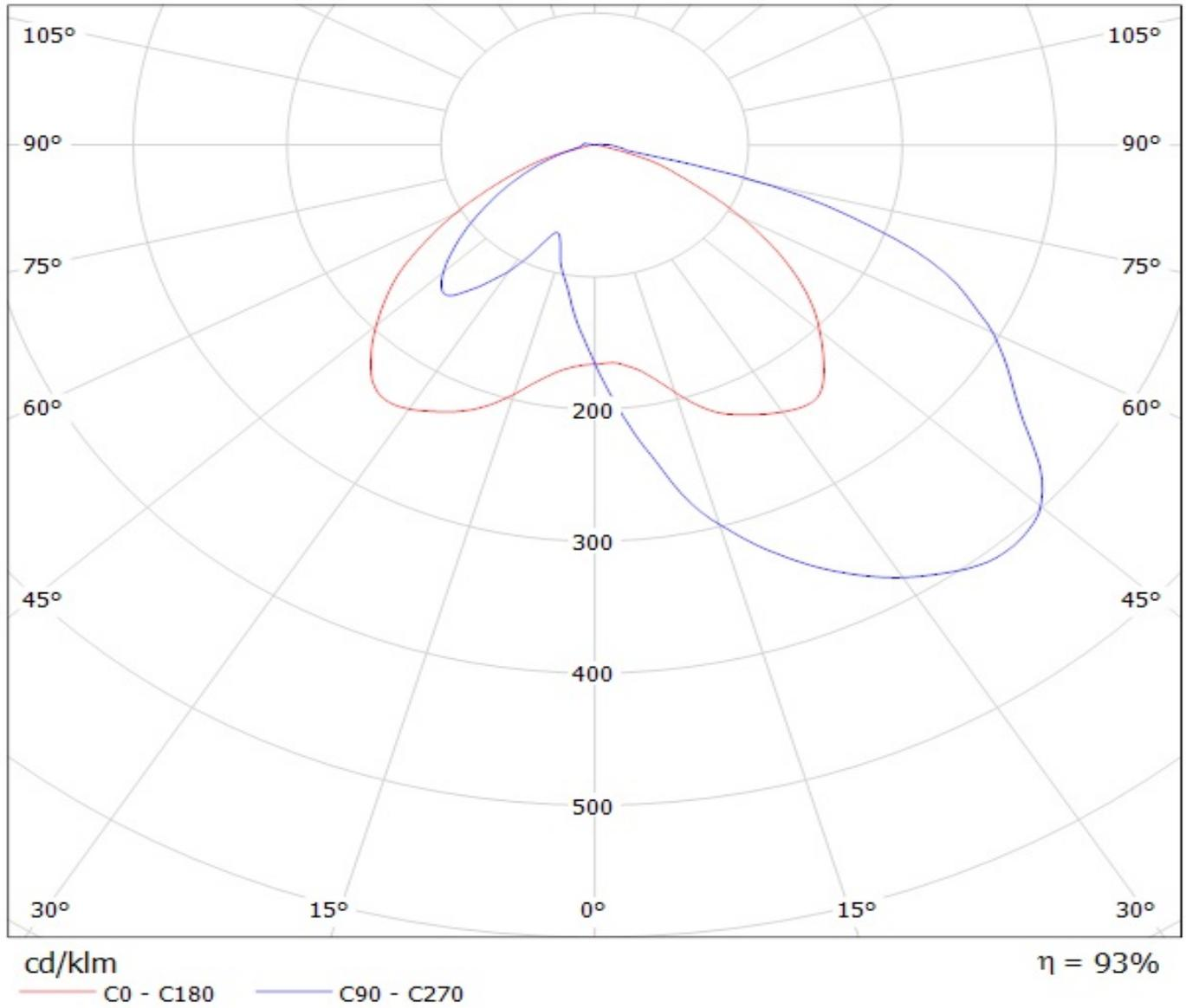

Ledil F14563_JENNY-T4_(CXA1520) / LDC (Polar)

Luminaire: Ledil F14563_JENNY-T4_(CXA1520)

Lamps: 1 x CREE_CXA1520_(-30F-N4-N0H-0001)_1029.79lm@250mA_CCT=3094K_P=8.46W_I=0.25A

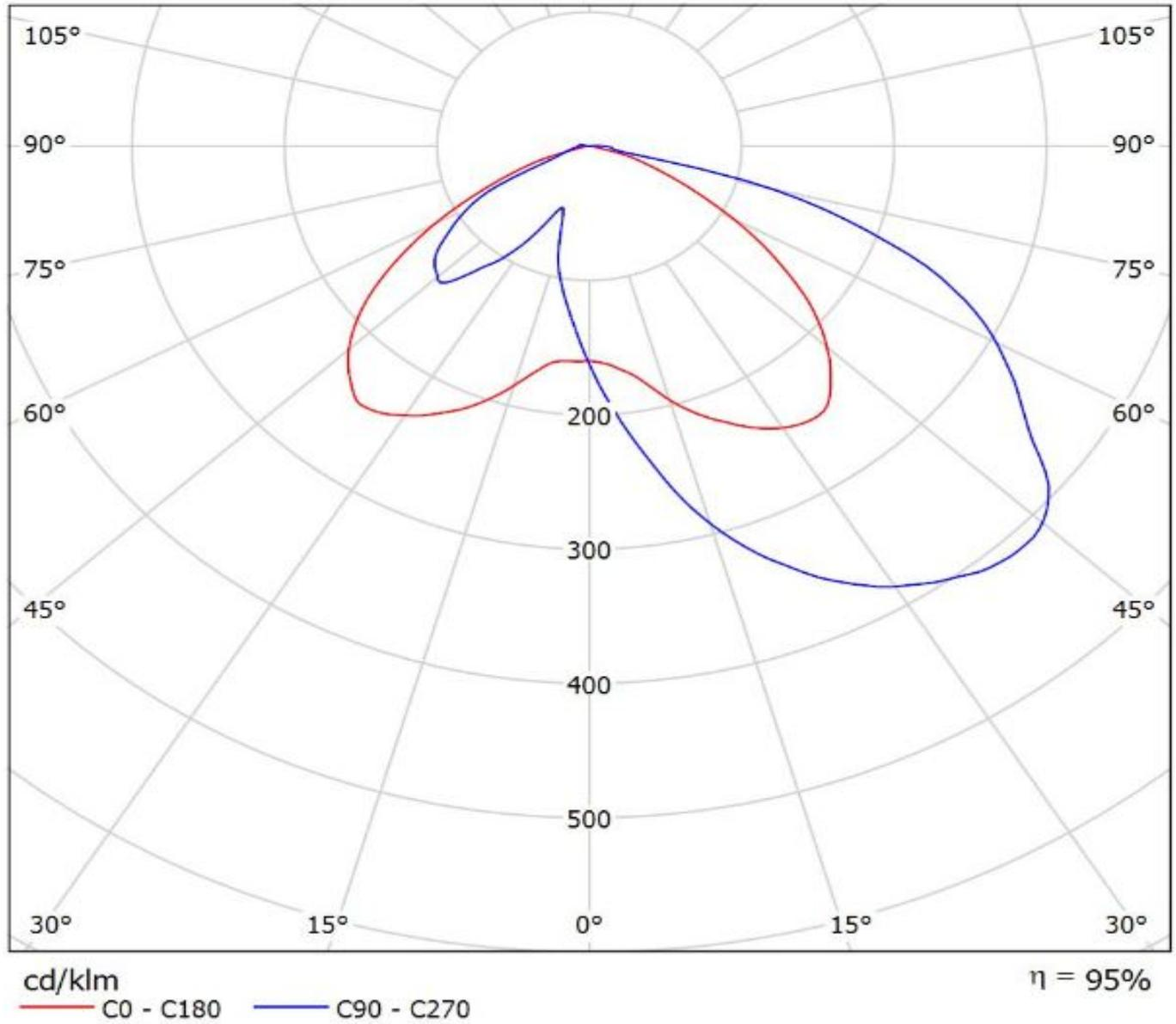

Luminaire: Ledil F14563_JENNY-T4_(Cree_XML_EZW)
Lamps: 1 x Cree_XML_EZW_133.676lm@250mA_P1.5=W_I=0.250A

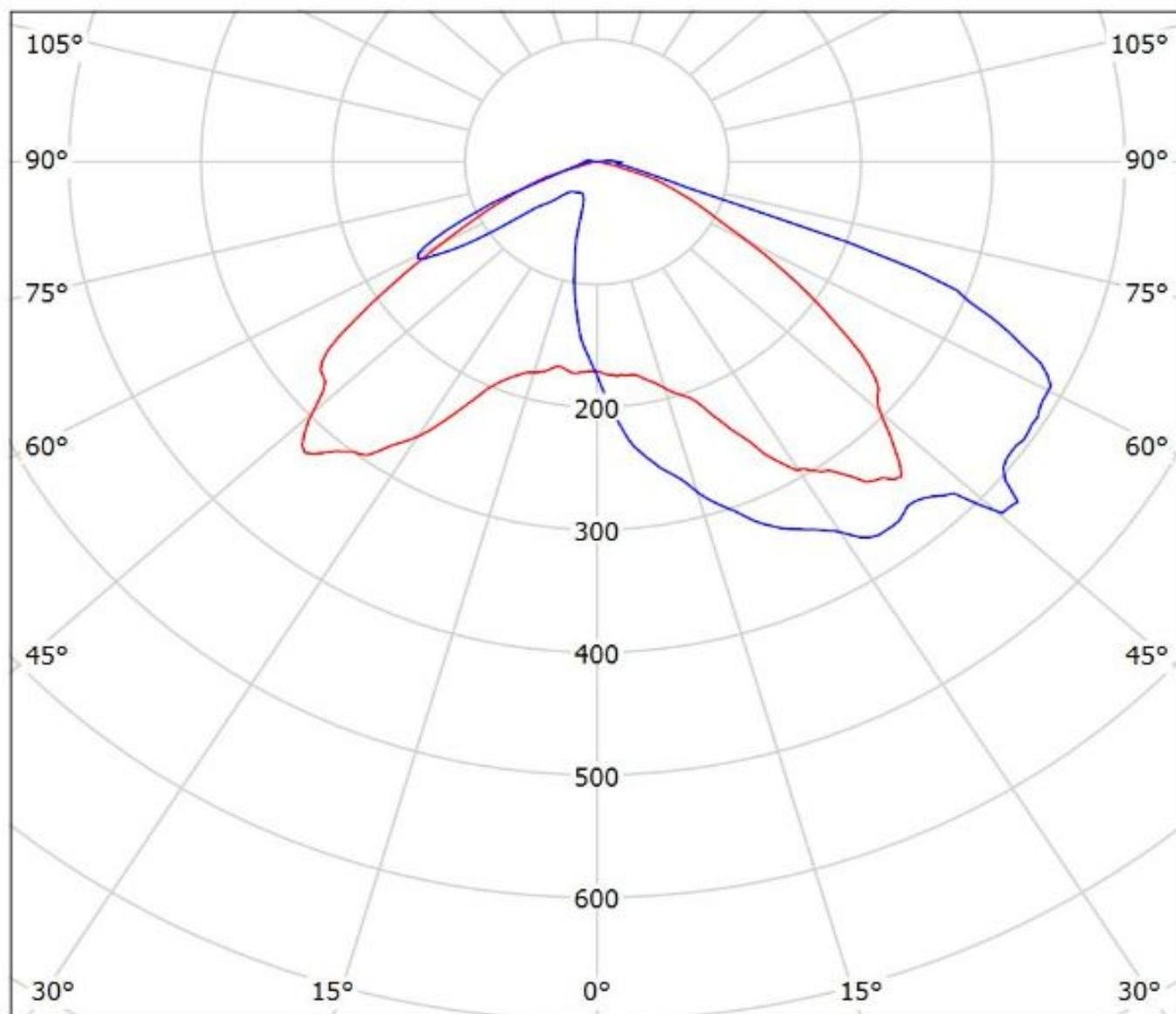

cd/klm

— C0 - C180 — C90 - C270

$\eta = 93\%$

Luminaire: Ledil F14563_JENNY-T4_(Cree_MK-R)

Lamps: 1 x Cree_MK-R_197.7lm@250mA_P=1.42W_I=0.250A

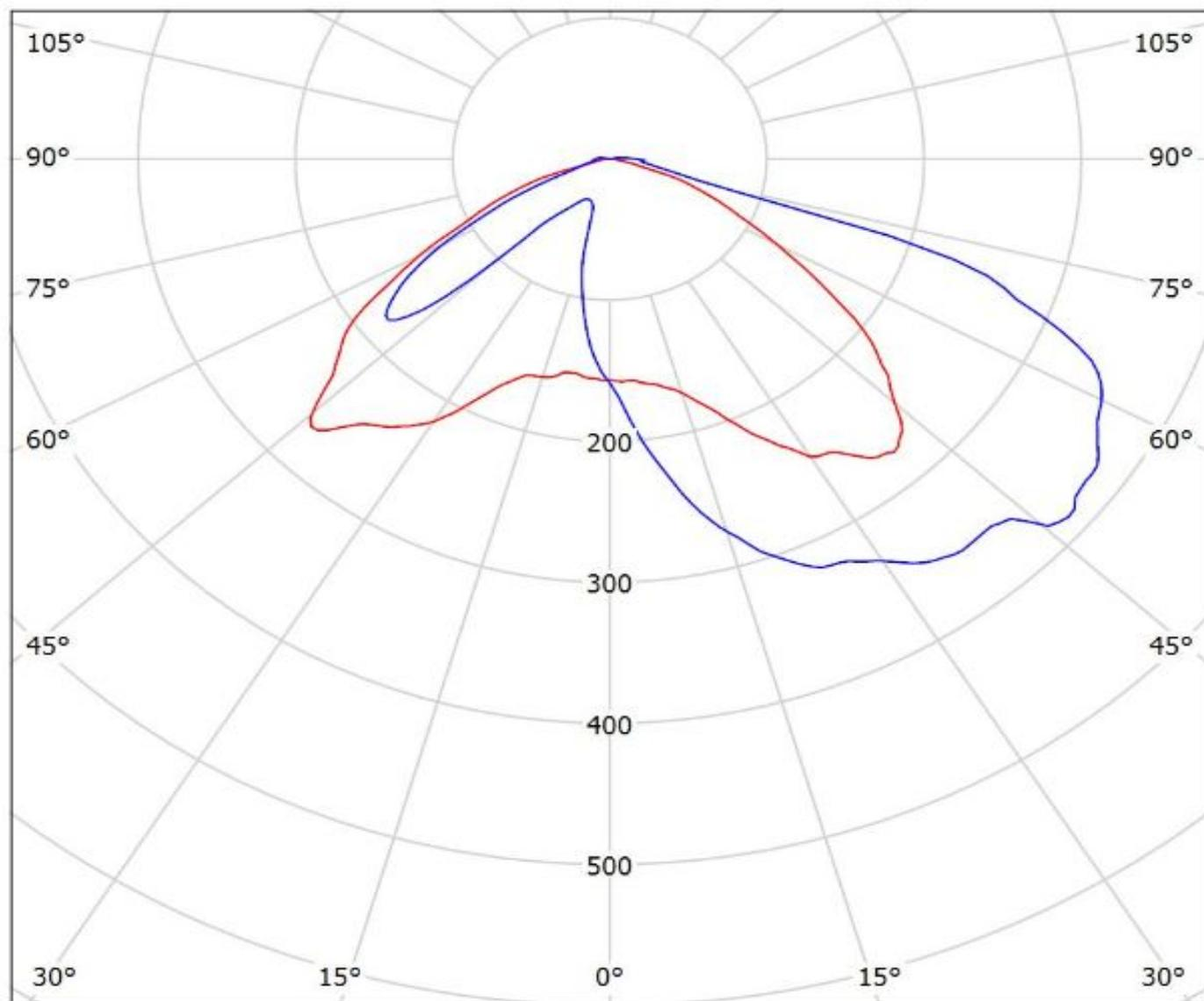

cd/klm

— C0 - C180

— C90 - C270

$\eta = 93\%$

Luminaire: Ledil F14563_JENNY-T4_(Cree_MX-6)

Lamps: 1 x Cree_MX-6_65.8lm@250mA_P0.86=W_I=0.250A

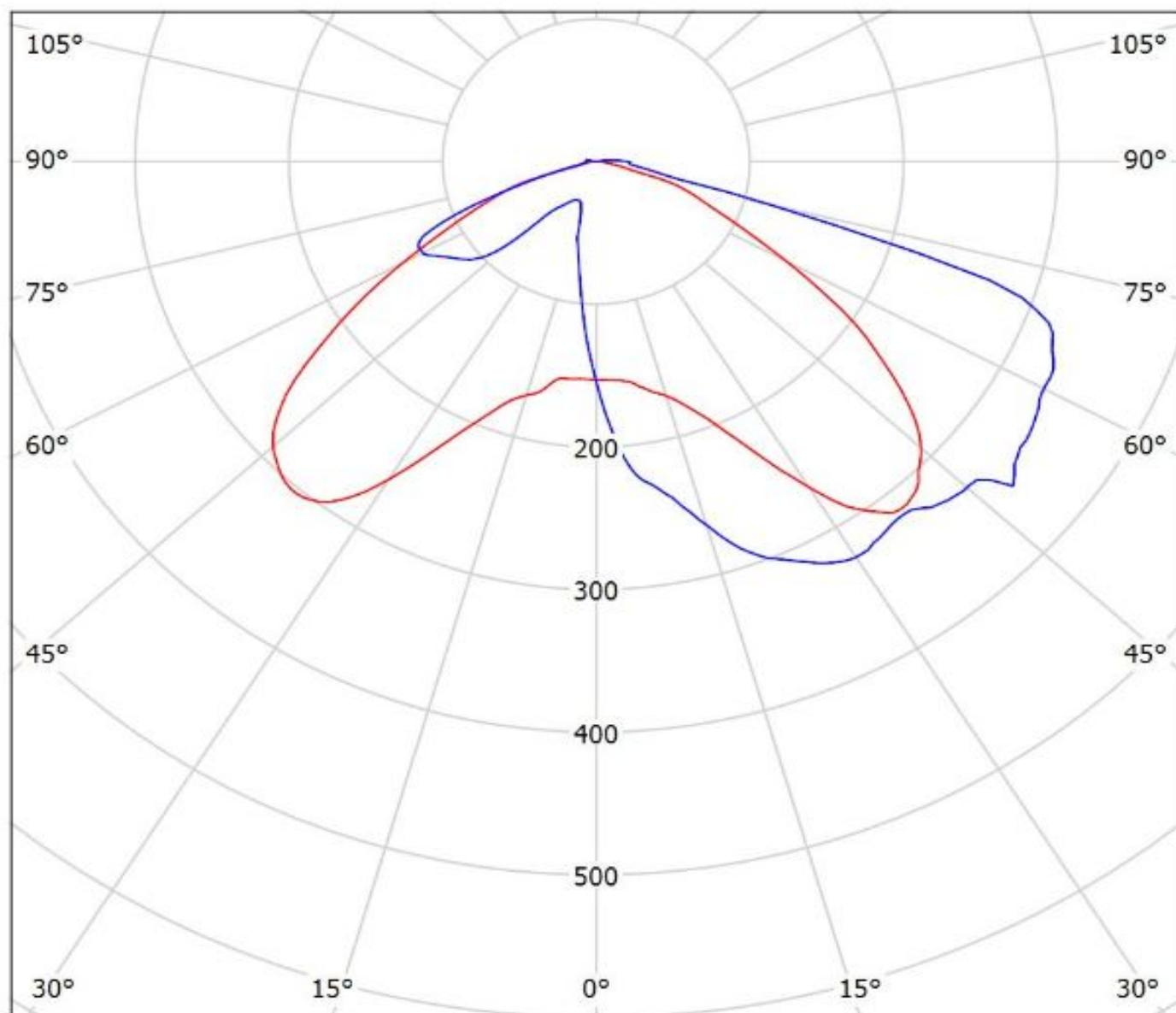

cd/klm

— C0 - C180 — C90 - C270

$\eta = 92\%$

Luminaire: Ledil F14563_JENNY-T4_(Cree_XHP-70)
Lamps: 1 x Cree_XHP-70_1m@250mA_P=W_I=0.250A

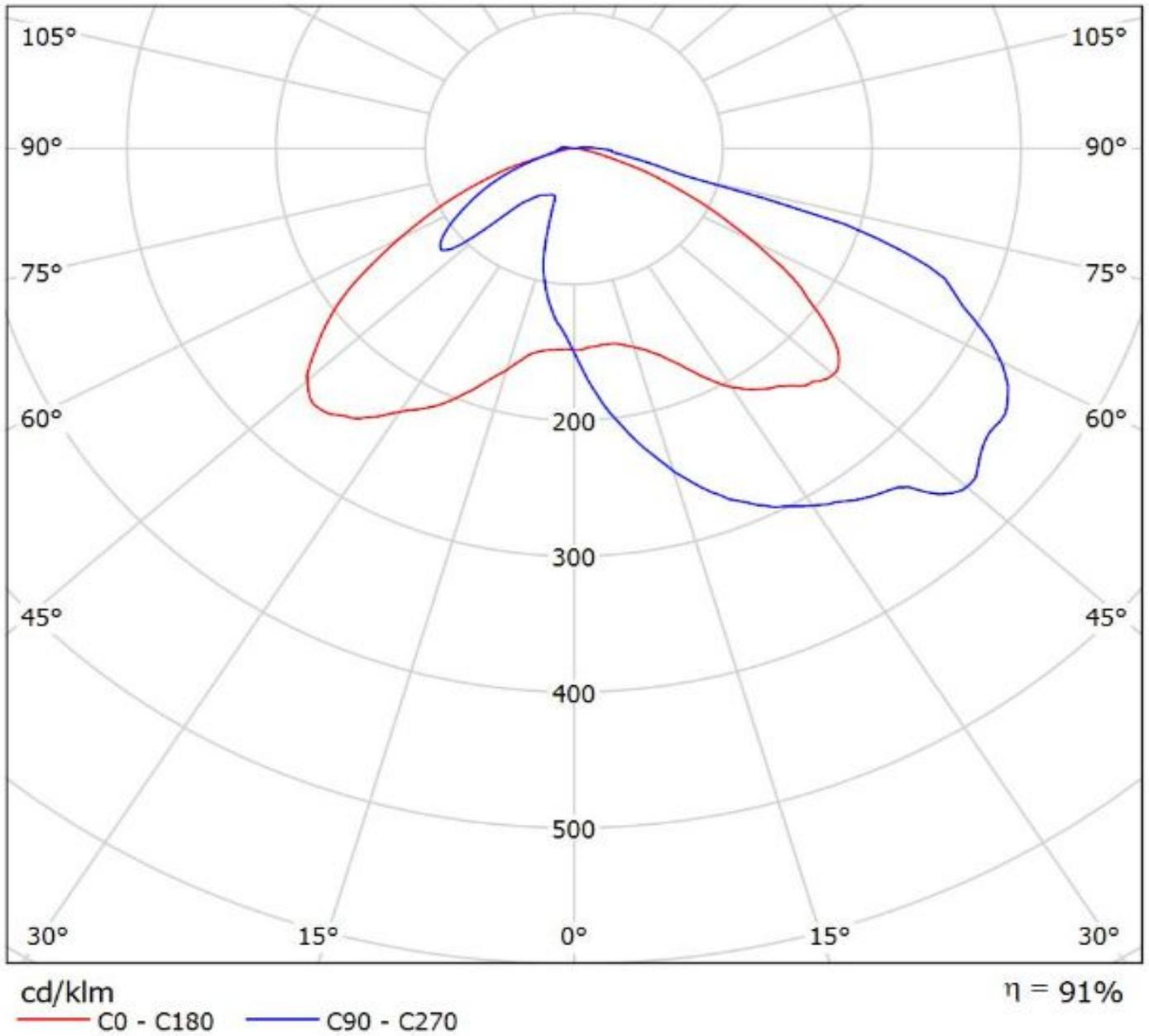

Luminaire: LEDiL Oy F14563_JENNY-T4_(Luxeon_M)

Lamps: 1 x Luxeon_M_(LXR8-SW30)_346.517lm@250mA_P=2.78838W_I=0.2499A

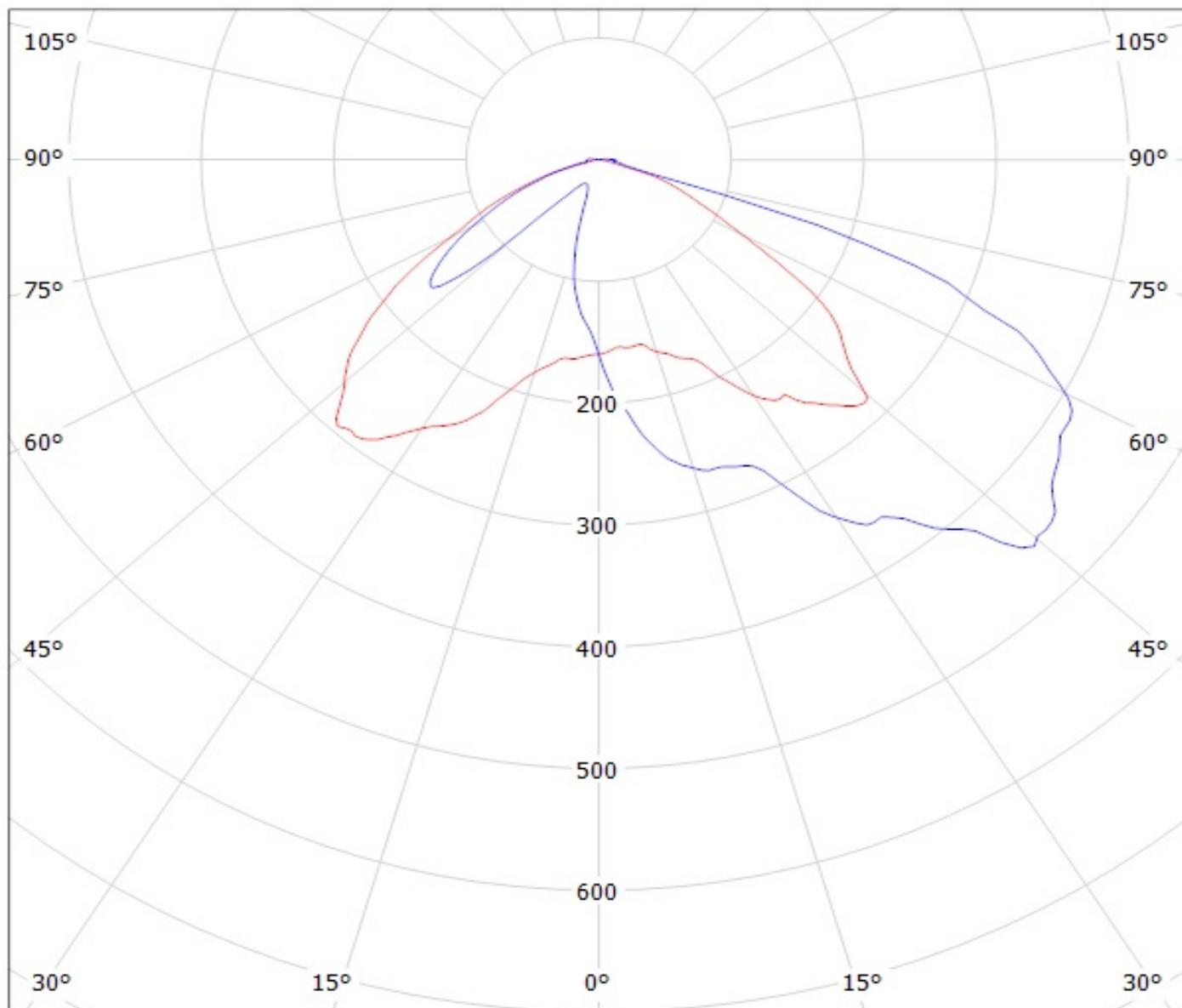

cd/klm

— C0 - C180

— C90 - C270

$\eta = 94\%$

Luminaire: LEDiL Oy F14563_JENNY-T4_(CXM-9)

Lamps: 1 x Luminus_XNOVA_CXM-9_960.72lm@240mA_P=8.2476W_I=0.24A

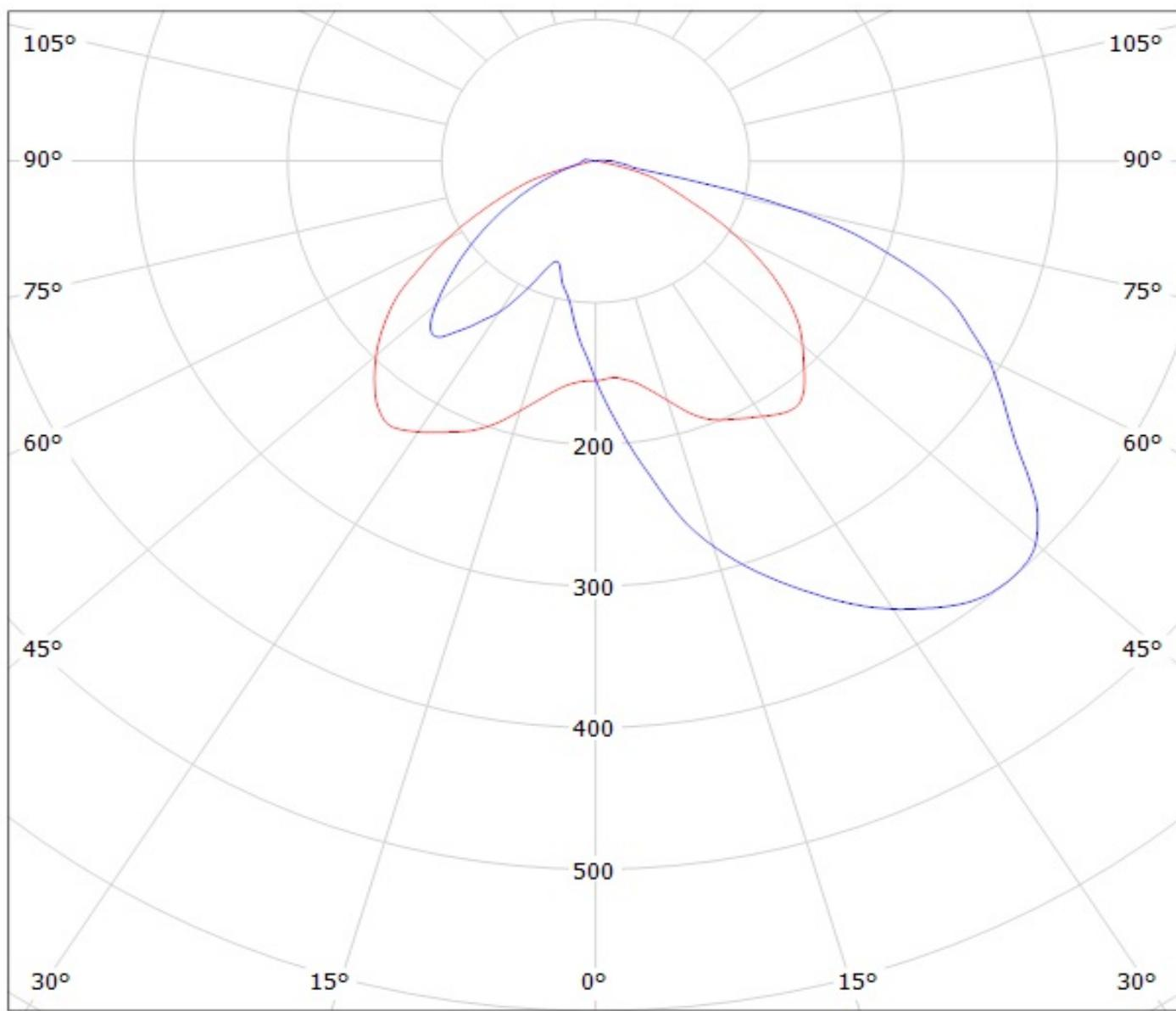

cd/klm

— C0 - C180

— C90 - C270

$\eta = 93\%$

Luminaire: Ledil F14563_JENNY-T4_(Soleriq_P9)

Lamps: 1 x Soleriq_P9_919.903lm@250mA_CCT=4372K_P=6.9W_I=0.250A

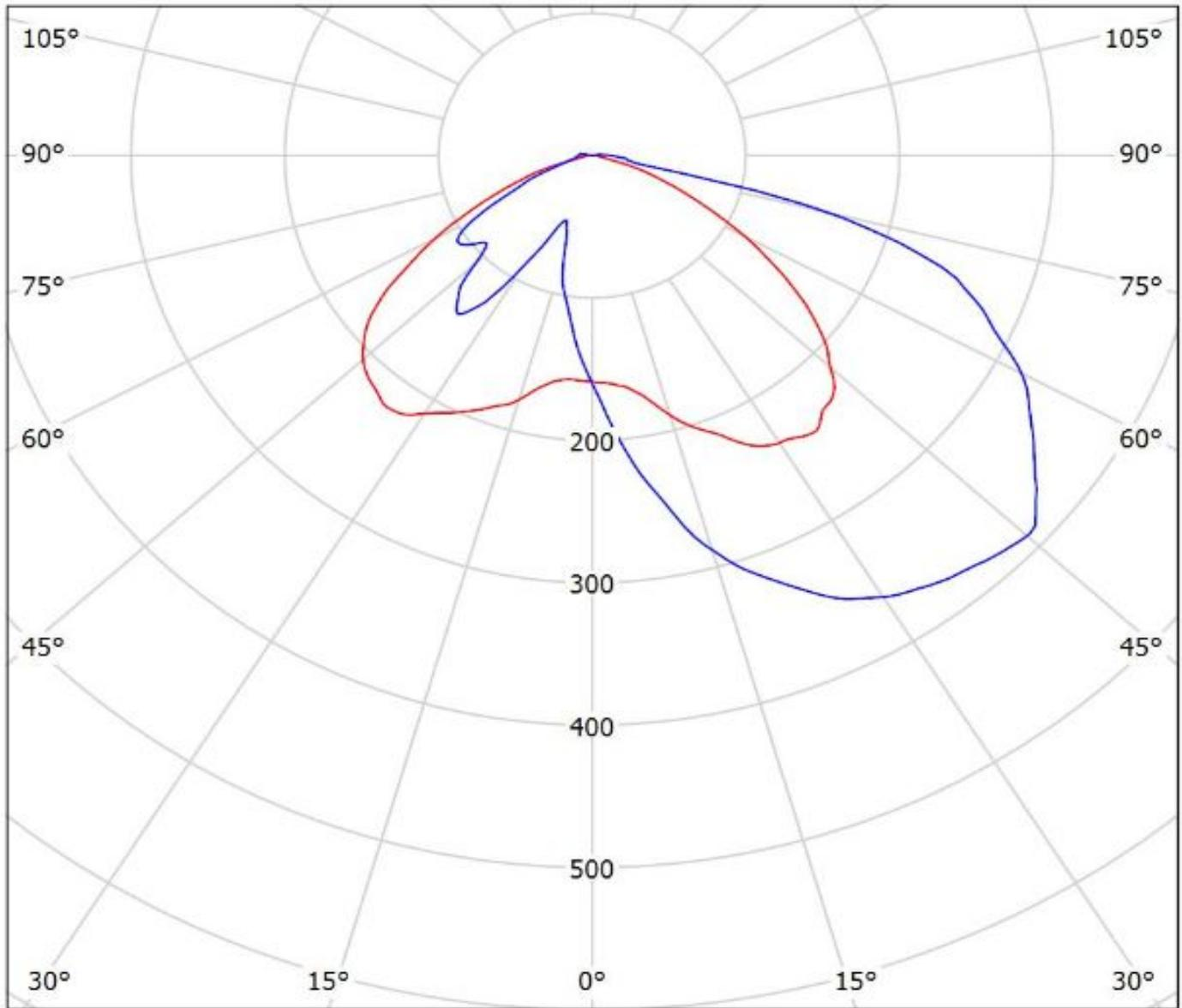

cd/klm

— C0 - C180 — C90 - C270

$\eta = 95\%$

Luminaire: LEDiL Oy FCN14875_JENNY-T4_(COB_D_LES_9.8mm)

Lamps: 1 x Samsung_COB_D_series_LES_9.8mm_LC013D_534.999lm@100mA_P=3.1948W_I=0.100A

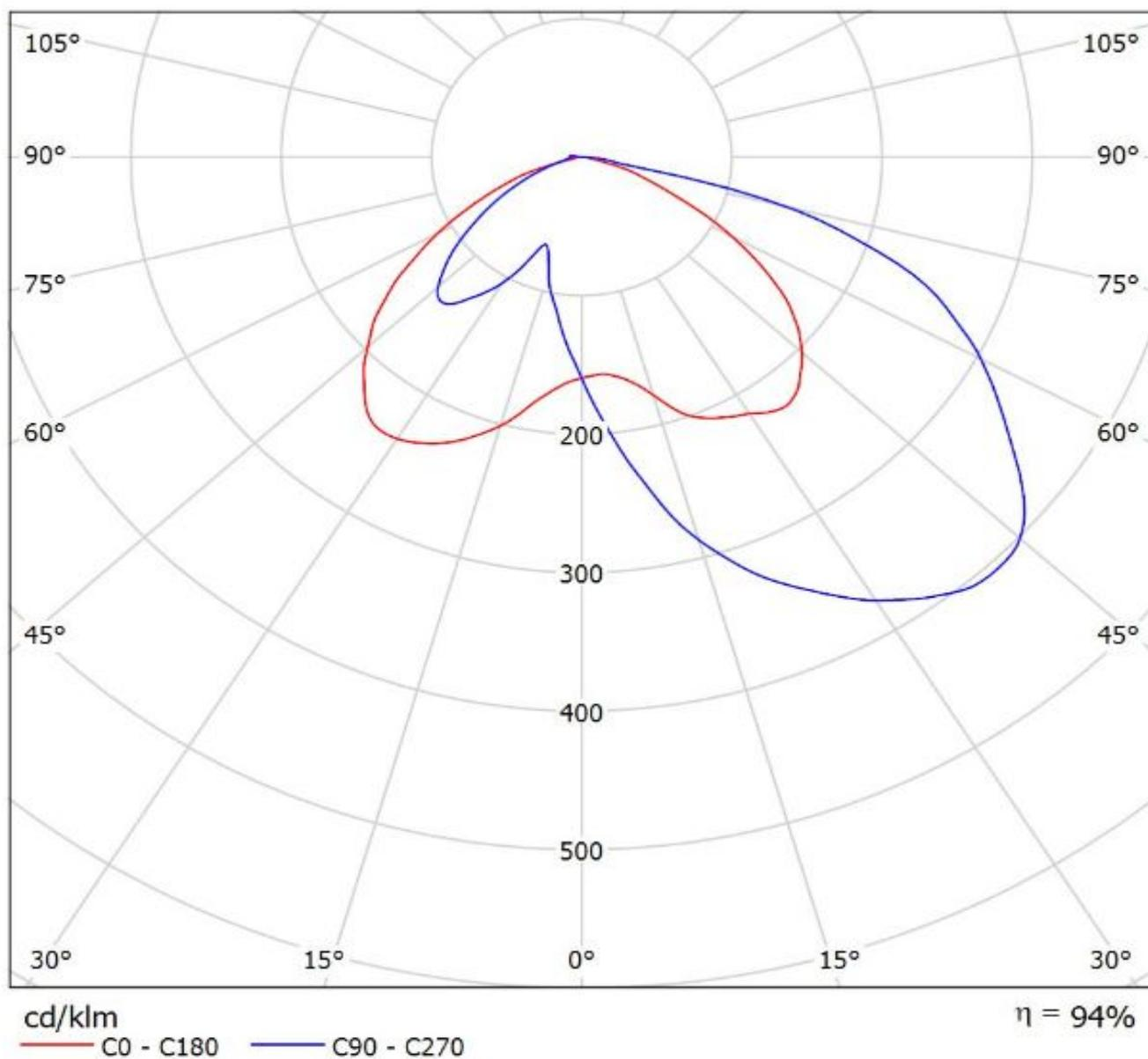

Luminaire: Ledil F14563_JENNY-T4_(MJT_12W_Les9,8)

Lamps: 1 x Seoul_MJT_12W_Les9.8mm_(SAWx1063A)_1245.58lm@250mA_P=8.30025W_η=0.25A

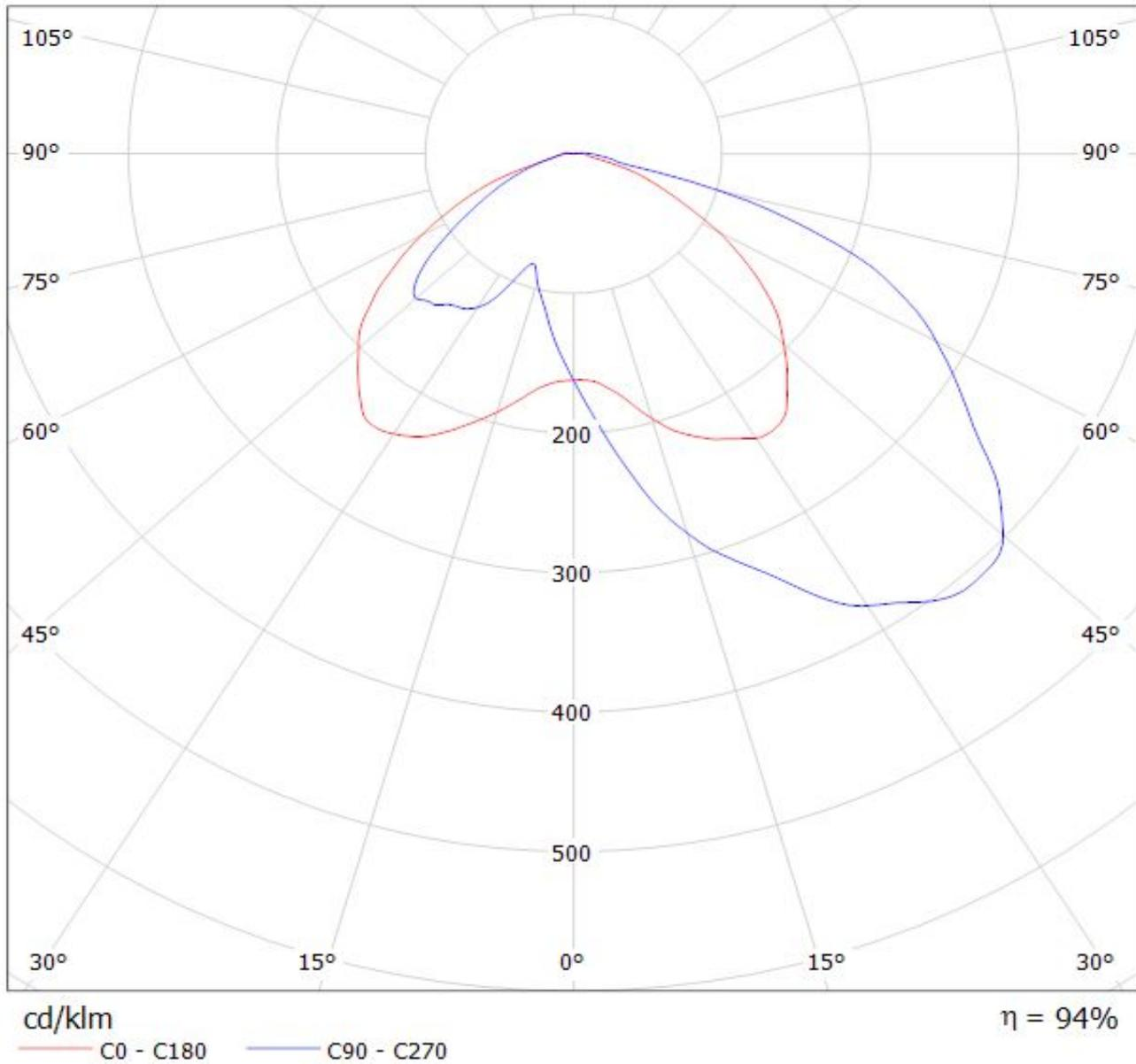

Luminaire: Ledil F14563_JENNY-T4_(MJT_6W_Les6)

Lamps: 1 x Seoul_MJT_6W_Les6mm_(SAWx0661A)_820.711lm@180mA_P=6.3909W_I=0.18A

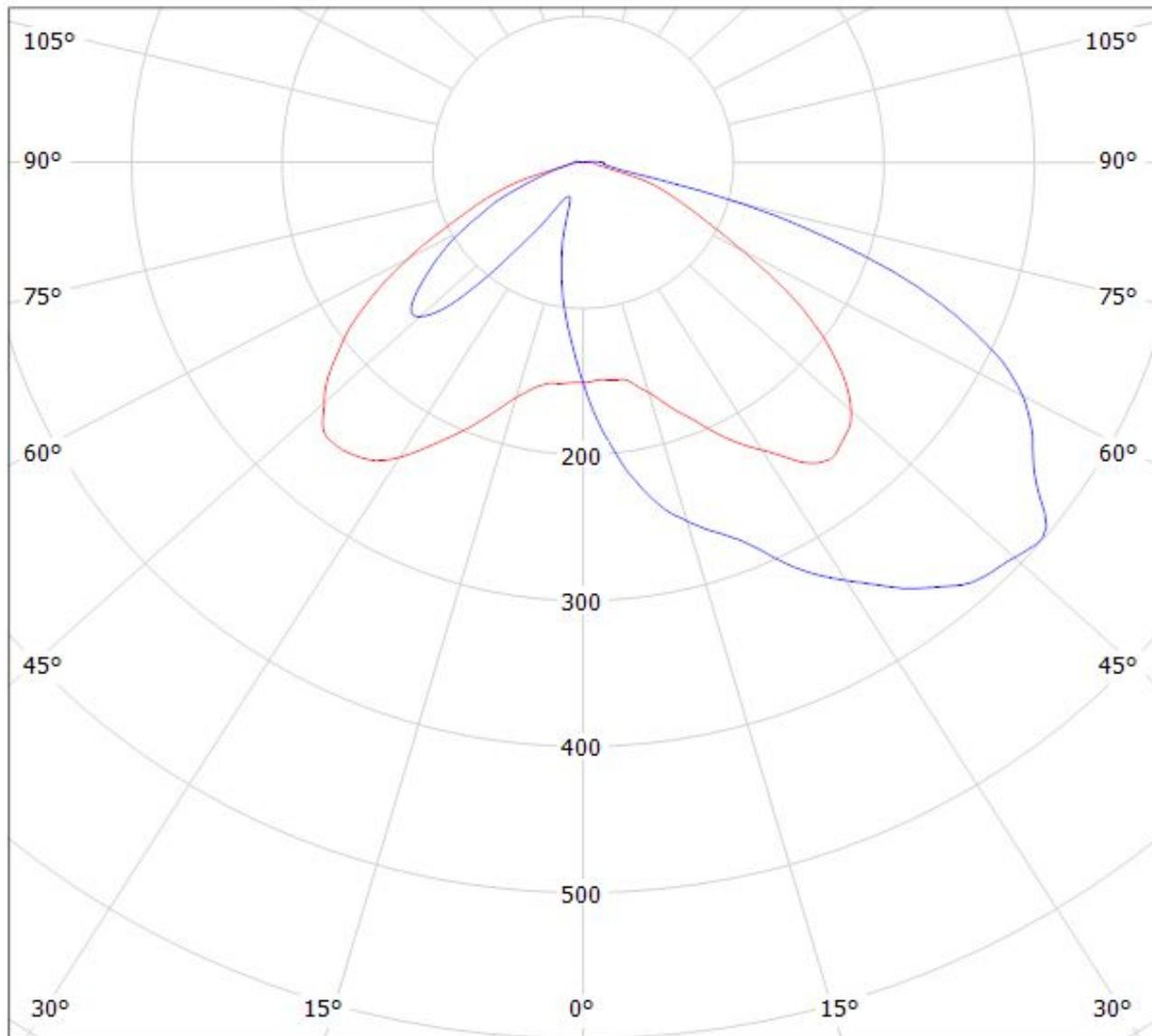

cd/klm

— C0 - C180

— C90 - C270

$\eta = 92\%$

Luminaire: LEDiL Oy F14563_JENNY-T4 (SLE-G5_LES-6)

Lamps: 1 x Tridonic_SLE-G5_LES-6_470.842lm@100mA_P=3.3743W_I=0.100A

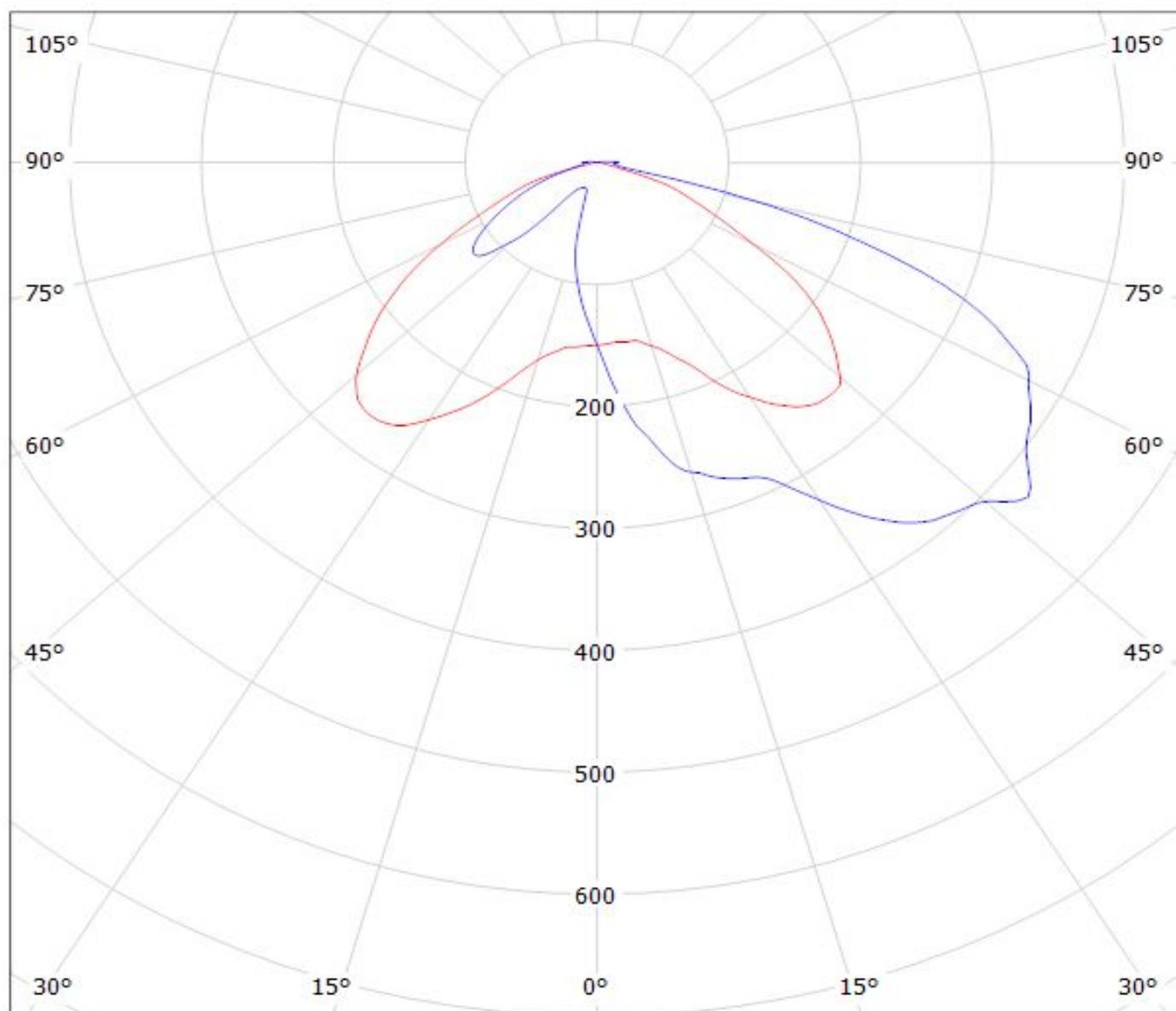

cd/klm

— C0 - C180

— C90 - C270

$\eta = 92\%$

Luminaire: LEDiL Oy F14563_JENNY-T4_(SLE-G5_LES-11)

Lamps: 1 x Tridonic_SLE-G5_LES-11_1179.13lm@250mA_P=8.3433W_I=0.250A

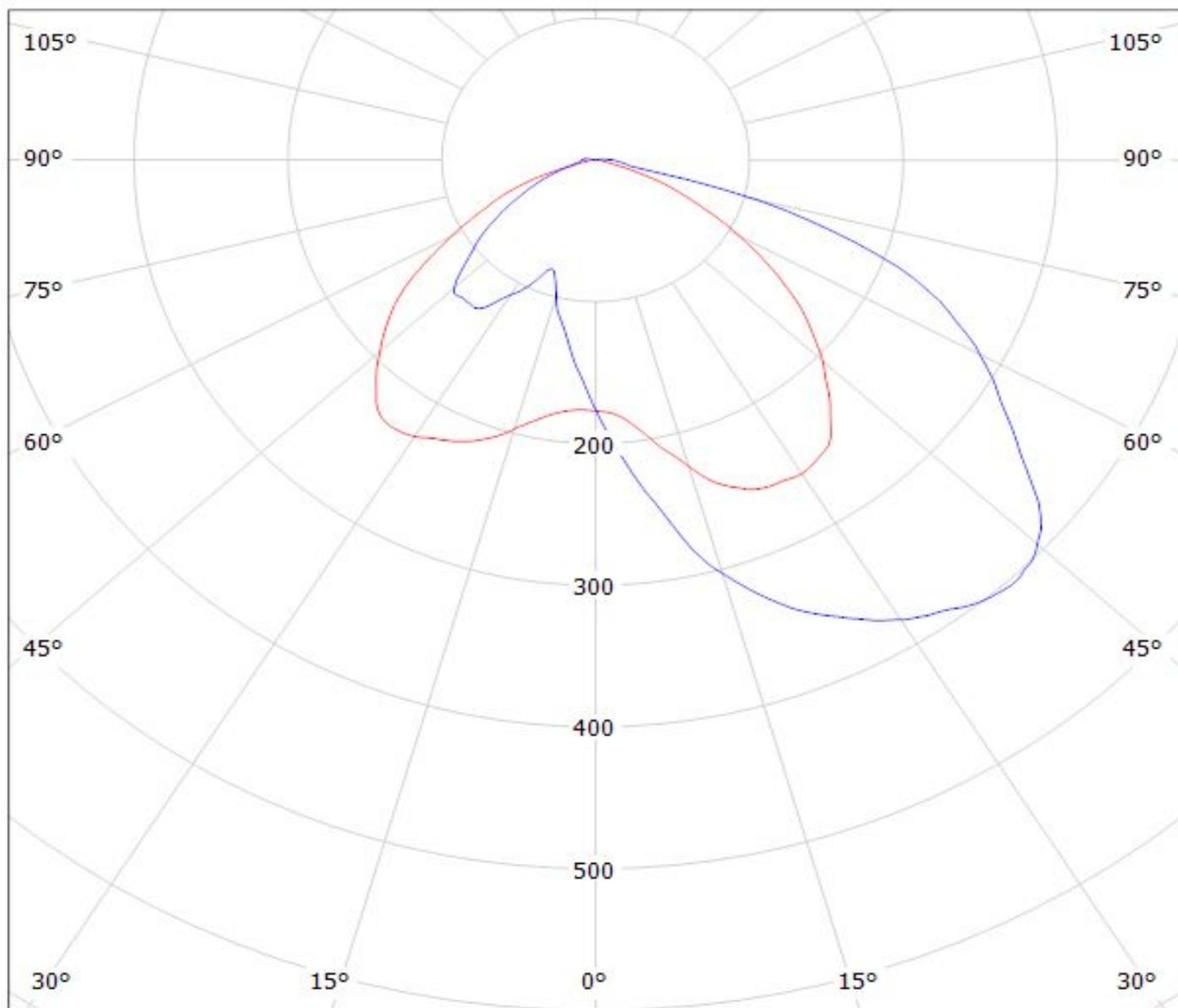

cd/klm

— C0 - C180

— C90 - C270

$\eta = 92\%$

NOTE: The typical divergence will be changed by different color, chip size and chip position tolerance. The typical total divergence is the full angle measured where the luminous intensity is half of the peak value.

GENERAL INFORMATION

- Product series especially designed & optimized for series of LEDs.
- Special care taken to make light distribution as uniform as possible.

Note! Due to use of high power COB's with this product, special attention to proper thermal design is highly recommended. LEDiL has no liability for direct, indirect or consecutive damages arising from the LEDiL products being used outside of the recommended temperature range.