

ELEV-8 Quadcopter Kit (#80000) Information and Assembly Guide

Features

- Four-rotor system with fixed-pitch blades
- Propeller P8X32A microcontroller flight control board
- Pre-programmed with flight-control software
- Custom plates protect motors and electronics
- Designed to easily attach a camera mount



Specifications

- Weight, without battery: 2.5 lbs (1.13 kg) fully assembled
- Payload capacity, excluding battery: ~ 2 lbs (0.9 kg)
- Average assembly time: 8 hours
- Height (assembled): 7.5 in (19 cm)
- Rotor-to-rotor width (centers, diagonal): 26 in (66 cm)

Additional Items Required

- RC radio controller and receiver, 5-channel minimum for flight
- LiPo Battery, 3000 to 4400 mAh 3-cell 30 C discharge rate
- LiPo Battery Charger

Application Ideas

- Hobby RC flying
- Aerial photography
- Flying tele-presence platform

⚠ CAUTION: READ ALL WARNINGS AND PRECAUTIONS (PAGE 2) BEFORE ASSEMBLY OR OPERATION!

READ THIS FIRST – IMPORTANT SAFETY INFORMATION!

- READ ALL WARNINGS AND PRECAUTIONS ON THIS PAGE BEFORE ASSEMBLY OR OPERATION!
- WARNING: CUTTING HAZARD. Rotating ELEV-8 quadcopter blades can cut skin and underlying tissues. Stay away from a powered ELEV-8 quadcopter and never become complacent during operation.
- WARNING: ENTANGLEMENT HAZARD. Secure long hair and loose clothing or jewelry when building, testing, and operating your ELEV-8 quadcopter to avoid entanglement with motors.
- WARNING: EYE HAZARD. Always wear eye protection when assembling, soldering, operating, or repairing your ELEV-8 quadcopter.
- Customer agrees to fly at Academy of Model Aeronautics (AMA) approved flying fields, maintaining insurance through their AMA membership.
- Inform yourself of and follow all current federal, state, and local laws regarding the use of hobby RC aircraft in the area where you plan to operate your ELEV-8 quadcopter. Review the FAA's rules in entirety – you are responsible for following them.
- An ELEV-8 quadcopter assembled and used as directed in in this document is an RC hobby aircraft and does not constitute the use of an autonomous UAV or drone. Modifying your ELEV-8 quadcopter to function as an autonomous UAV or drone is not supported, recommended, or endorsed by Parallax Inc. If you choose to modify your ELEV-8 quadcopter to function as an autonomous UAV or drone, you do so entirely at your own responsibility and risk.
- This kit is not for beginners. Advanced mechanical skill is required for building and flying an ELEV-8 quadcopter. RC aircraft experience is highly recommended.
- Follow the instructions carefully; incorrect assembly of your ELEV-8 quadcopter could cause risk of catastrophic equipment failure, personal injury to you or others, and property damage.
- Perform initial electronic speed controller (ESC) programming before installing the propeller blades. Remove propeller blades before reprogramming the ESCs.
- Establish and test the radio link between the RC controller and RC receiver before installing the propeller blades. Remove propeller blades before testing a different controller.
- Always disconnect the battery when not in use.
- Store your ELEV-8 quadcopter and its radio controller out of reach of children, pets, and those who do not know how to use them safely.
- Only operate your ELEV-8 quadcopter in an area with no children, unsecured pets, or livestock, which can be harmed by contact with rotating blades. For example, children and dogs may try to jump and catch a flying quadcopter, or may run to investigate one that has just landed.
- Only operate your ELEV-8 quadcopter outdoors and away from crowded areas. All observers should stand a safe distance **behind** the operator.
- Only operate your ELEV-8 quadcopter in an environment where you can maintain unobstructed visual contact with it. Do not operate at night, or where there is fog, smoke, or dust that could limit visibility.
- Keep your ELEV-8 quadcopter dry! Do not submerge your ELEV-8 quadcopter or operate it in rainy or damp conditions. Beware of sprinklers and of landing in wet vegetation.
- Check the wind speed before flying your ELEV-8 quadcopter. Even a light breeze can make flying difficult for beginners. No one should fly in high winds.

DISCLAIMER OF LIABILITY: PARALLAX INC. IS NOT RESPONSIBLE FOR ANY SPECIAL, INCIDENTAL, OR CONSEQUENTIAL DAMAGES AND PERSONAL INJURIES, INCLUDING THAT TO LIFE AND HEALTH, RESULTING FROM THE CUSTOMER'S APPLICATION AND USE OF ANY PARALLAX INC. PRODUCTS. YOU, THE CUSTOMER, ASSUME FULL AND UNLIMITED RESPONSIBILITY FOR ALL CUSTOMER ELEV-8 QUADCOPTER APPLICATIONS AND USES.

Bill of Materials

This bill of materials is provided so you may inventory each bag in your ELEV-8 Quadcopter Kit before beginning construction. If you are missing any parts, contact sales@parallax.com directly for assistance. Note that some items are small sub-kits with additional components not listed separately. Parts and quantities subject to change without notice. Some items are available online from www.parallax.com.

ELEV-8 Quadcopter Kit Contents (#80000)			ELEV-8 Hardware Kit (#80060)			ELEV-8 Electronics Kit (#80070)		
Part #	Qty	Description	Part #	Qty	Description	Part #	Qty	Description
31500	1	Hoverfly OPEN Board	900-00021	2	Nylon Strap, Black	800-00080	5	3-wire ext.,.22AWG,F/F,8"
700-10003	1	Safety glasses	725-00067	1	1.5 mm Hex Key	800-00039	6"	1/2" Heat Shrink Tubing (black)
80050	1	ELEV-8 Airframe Kit	720-28001	1	Light Pipe	800-00036	24"	3/4" Heat-shrink Tubing (clear)
80060	1	ELEV-8 Hardware Kit	713-00051	4	Spacer,#4x1/2",NY	800-00023	27"	3/16" Heat-shrink Tubing (black)
80070	1	ELEV-8 Electronics Kit	713-00043	16	Standoff, #4-40, 5/8", Nylon	800-00022	2	16" Black Pluggable Jumper-Male
85000	1	ESC Programming Card*	713-00025	4	Standoff, #4-40,1 1/4", Nylon	800-00021	2	16" Red Pluggable Jumper-Male
ELEV-8 Airframe Kit Contents (#80050)			712-00004	4	Washer, #6, 3/8" OD, Zinc	750-90002	4	Brushless 1000Kv Motor
Part #	Qty	Description	710-00100	8	Screw, #4-40, 1/4", PH, Black	750-90000	4	Gemfan 30A ESC Speed Controller
730-00060	4	ELEV-8 Boom (Black)	710-00042	4	Screw, #4-40, 1-1/4", PH, SS	750-00059	18"	12AWG Red Wire
721-80010	1	ELEV-8 Control Board Top Plate	710-00039	16	Screw, 3x6 mm,0.5 thread, black	750-00058	1.5	12AWG Black Wire
721-80007	4	ELEV-8 Landing Gear	710-00036	24	Screw, #4-40, 3/8", PH, SS	750-00056	15	16AWG Red Wire
721-80005	4	ELEV-8 Motor Mount Top/Bottom	710-00002	16	Screw, #4-40, 1",PH,SS	721-80001	2	10x4.7 Slow Flyer CW 1045R Blade
721-80003	2	ELEV-8 Quad Chassis	700-00106	1	Loctite 242	721-80000	2	10x4.7 Slow Flyer CCW 1045 Blade
721-80002	1	ELEV-8 Control Board Mount Plate	700-00093	12	Zip Tie, 4" Black	452-00088	1	EC3 Plugs(10 pairs/sets)
			700-00059	16	Internal-tooth Lock Washer, #4, Zinc	450-00050	2	Extra Gold Bullet Conn 10-Pak
			700-00024	4	Locknut #4-40, 1/4"	350-00045	8"	White LED Tape
						350-00044	8"	Red LED Tape
						120-00007	8"	Red/White Checkered Sticker
						120-00006	8"	Black/White Checkered Sticker
						800-00080	5	3-wire ext.,.22AWG,F/F,8"

*Note: The ESC Programming Card was added to kits in April 2013. They are also available separately from www.parallax.com; search "85000".
Version 1.1: Bill of Materials correction.

ELEV-8 QUADCOPTER ASSEMBLY INSTRUCTIONS

These instructions are for assembling the ELEV-8 quadcopter in its most standard configuration. Some steps are optional; we'll explain those along the way. The ELEV-8 quadcopter platform is designed for creative experimentation and adaptation; however, we recommend that you try the standard configuration first, and then experiment at your own educated risk.

These instructions are available online as a full-color PDF; go to www.parallax.com and search "80000".

Preparation

1. Read the entire assembly instructions before beginning. Assembly and testing takes about eight hours on average.
2. If you are missing any components, email support@parallax.com or call 888-512-1024 (inside continental US) or 916-624-8333.
3. Gather all of the additional items and tools required.
4. Charge your LiPo batteries with their charger.

Additional Items Required

- RC radio controller and receiver; 5-channel minimum required for flight
- LiPo Battery, 3000 to 4400 mAh 3-cell 30 C discharge rate
- LiPo Battery Charger

Tools Required

- Soldering iron, solder, and flux
- Component vise
- #1 Phillips screwdriver
- 1/4 inch wrench, box-end or socket
- 11/32 inch wrench or nut driver
- Wire strippers/cutters (12-16 AWG)
- Scissors
- Needle-nose pliers
- Ruler or measuring tape
- Heat gun or blow dryer (for heat-shrink tubing)

Step 1: Motor Set Screws

Start by applying Blue Loctite to the motor set screws, to prevent them from coming loose during flight and causing equipment failure.

1. Locate the Blue Loctite 242, the four motors, and the small Allen wrench in the ELEV-8 Hardware Kit.
2. Refer to the drawing on the next page. Using the Allen wrench, carefully remove the Motor Set Screws (item 2) from each motor (item 1). The screws may be very tight; be careful not to break your Allen wrench.
3. For each motor, apply a small amount of Blue Loctite to the Set Screw threads and carefully reinstall the screws. Seat each screw firmly but do not over-tighten. Allow the Blue Loctite to set for 10 minutes. It fully cures in 24 hours.



**USE BLUE LOCTITE
BEFORE INSTALLING**

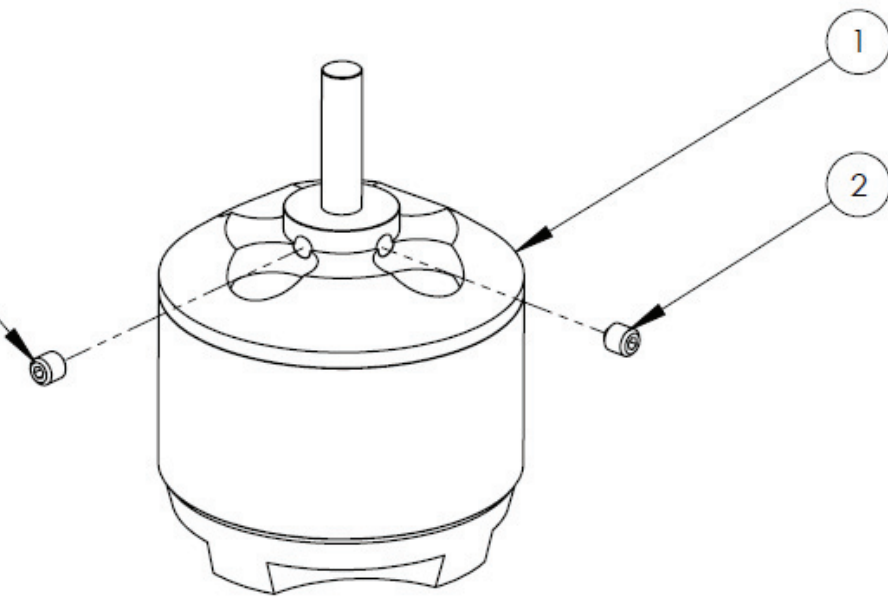

ITEM NO.	DESCRIPTION	QTY.
1	Motor 2	1
2	SET SCREW	2

Step 2: Solder the Motor and ESC Speed Controller Connectors

In this step you will solder long leads to the motors. Then, you will solder EC3 connectors to each lead and each Electronic Speed Controller (ESC). The EC3 connectors will give you the ability to switch around the wire connections when you check your motor direction later in the build. Be sure to use all of the same "gender" for the leads, and all of the opposite "gender" for the speed controllers. Follow the instructions below.

1. Gather together your motors, the red 16 AWG wire, EC3 connectors, wire cutters, wire stripper, ruler, and soldering supplies.
2. Using a ruler and wire cutters, measure and cut twelve lengths of the red 16 AWG wire, each 12 inches (30.5 cm) long.
3. Use wire strippers to remove the insulation and expose about 1/4 inch (0.6 cm) of metal at one end, and 1/8 inch (0.3 cm) at the other end.
4. Solder a wire (the 1/4-inch exposed end) to each lead on all four motors.
5. For this step, use all male or all female EC3 connectors (we used male EC3s here). To solder an EC3 connector to the opposite end of each lead, insert the 1/8-inch exposed tip of the wire into the cup end of the bullet connector, and fill the cup with solder.

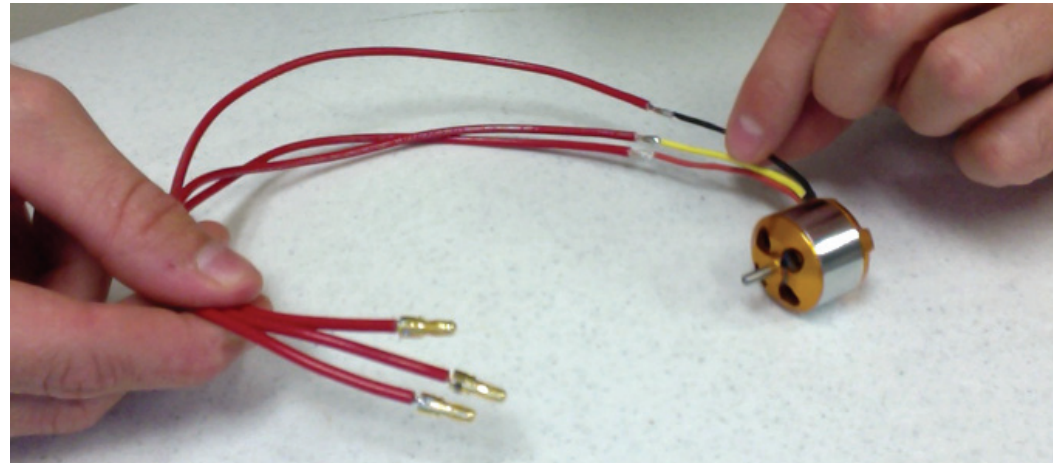
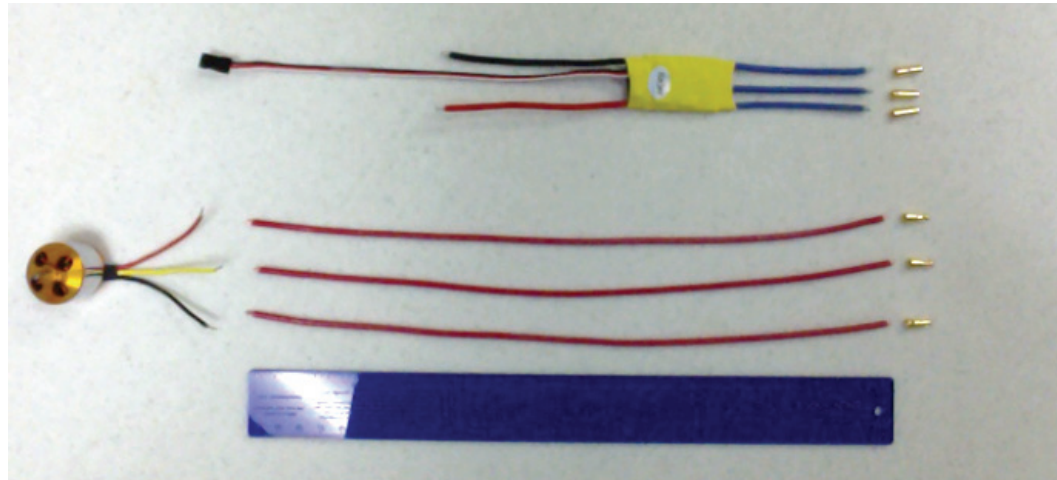

6. If necessary, use wire strippers to expose 1/8 inch (0.3 cm) of metal on the end of each speed controllers' blue wire leads.
7. Solder an opposite-gender EC3 connector to the end of each speed controllers' blue leads.

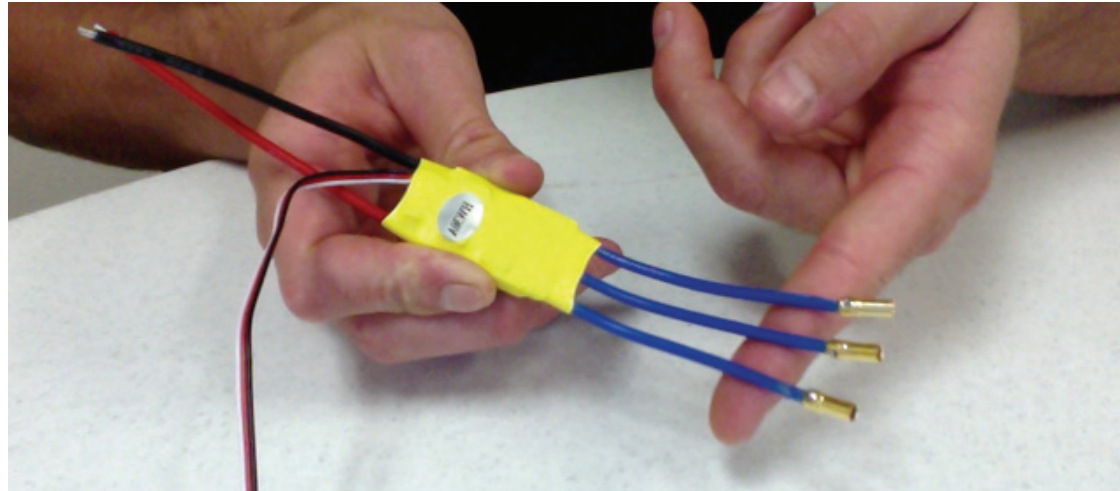

8. Connect the male EC3 connectors to the female EC3 connectors of your speed controller, to verify that they fit properly.
9. Disconnect them again for now.

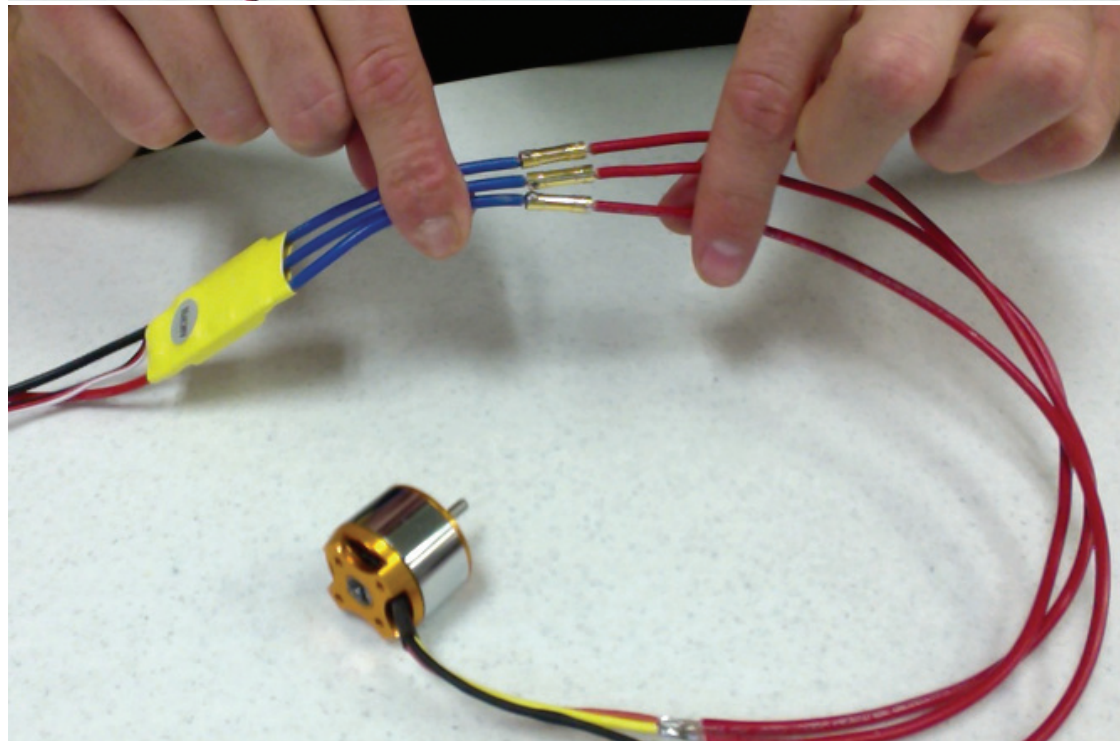

Step 3: Apply Heat-shrink Tubing to Motor and ESC Leads

Heat-shrink tubing will protect the solder joints and prevent unintended electrical contact. In the top picture, the tubing is fully shrunk over the motor-ESC lead solder joints. However, in the bottom picture, the tubing is only partially shrunk over an ESC lead's EC3 connector. This keeps the leads from accidentally making contact with each other, yet the connectors to be plugged and unplugged if needed when testing motor connections in a later step.

1. Locate the 27-inch length of 3/16" black tubing. Measure and cut it into 3/4-inch (1.9 cm) pieces, 36 pieces total.
2. Slip a piece of tubing over each solder joint on each motor lead.
3. Apply heat with a heat gun or blow dryer to shrink the tubing over the solder joint, as shown (top).
4. Slide a piece of tubing over an ESC lead.
5. Plug in the opposite connector from the motor assembly. Position the tubing to cover both connectors and solder joints.
6. Disconnect the motor assembly lead but keep the tubing in place. Carefully apply heat to just the very end of the tubing where it covers the ESC lead and connector solder joint. Apply just enough heat to secure the tube to the wire behind the connector, as shown in the picture (left). Do not let the other end of the tubing shrink.
7. Test that you can still plug and unplug the motor lead connector into the ESC connector.
8. Repeat with the other 11 ESC leads, and then disconnect the motors from the ESCs for now.

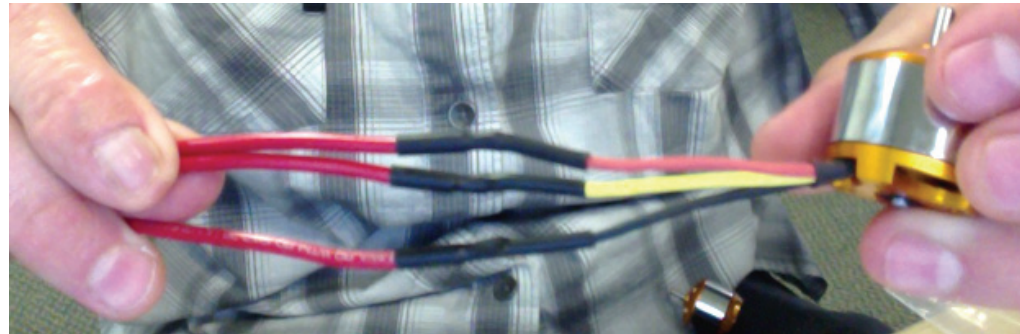

Step 4: Motor Mount Assembly

In this step, you will attach the Motor Mounts, Motors, and Landing Gear legs to the Booms. **DO NOT ATTACH THE PROPELLERS TO THE MOTORS YET.**

1. Gather the items listed in the diagram on the next page.
2. Attach each Motor (item 1) to a Motor Mount Bottom plate (item 8). Use four 3 mm x 6 mm screws (item 9) for each motor.
3. Use two 3/8" Panhead Screws (item 5) and two Internal Tooth Lock Washers (item 6) to attach two 5/8" Nylon Standoffs (item 7) to each Motor Mount bottom plate. Use two more 3/8" Panhead Screws and Internal Tooth Lock Washers (item 6) to attach each Motor Mount top plate (item 3) to the Nylon Standoffs (item 7).
4. One end of each Boom (item 4) has two holes spaced about one inch apart. Slide an assembled Motor Mount on this end of each Boom so that the motor leads go through the Boom tube. Holes in the Motor Mount top and bottom plates will line up with the holes in the Boom.
5. Secure each Motor Mount assembly to the last hole in its Boom with a 1" Pan Head Screw (item 2) and a Lock Nut (item 10).
6. Thread a 1" Pan Head Screw (item 2) through the second hole in each Boom and Motor Mount assembly. This screw does not use a lock nut. Instead, self-tap the screw into the shorter leg of a Landing Gear (item 11) aligned parallel to the Boom.

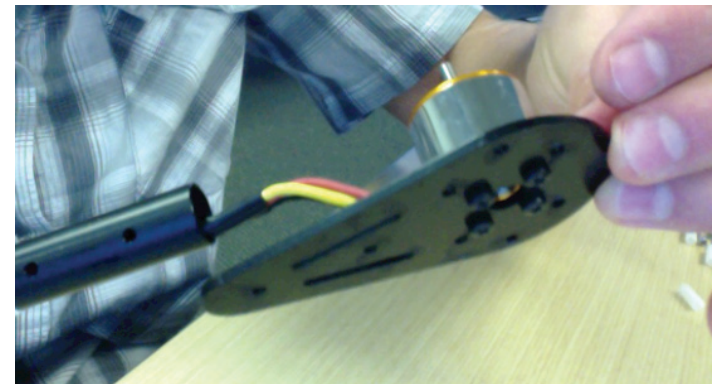

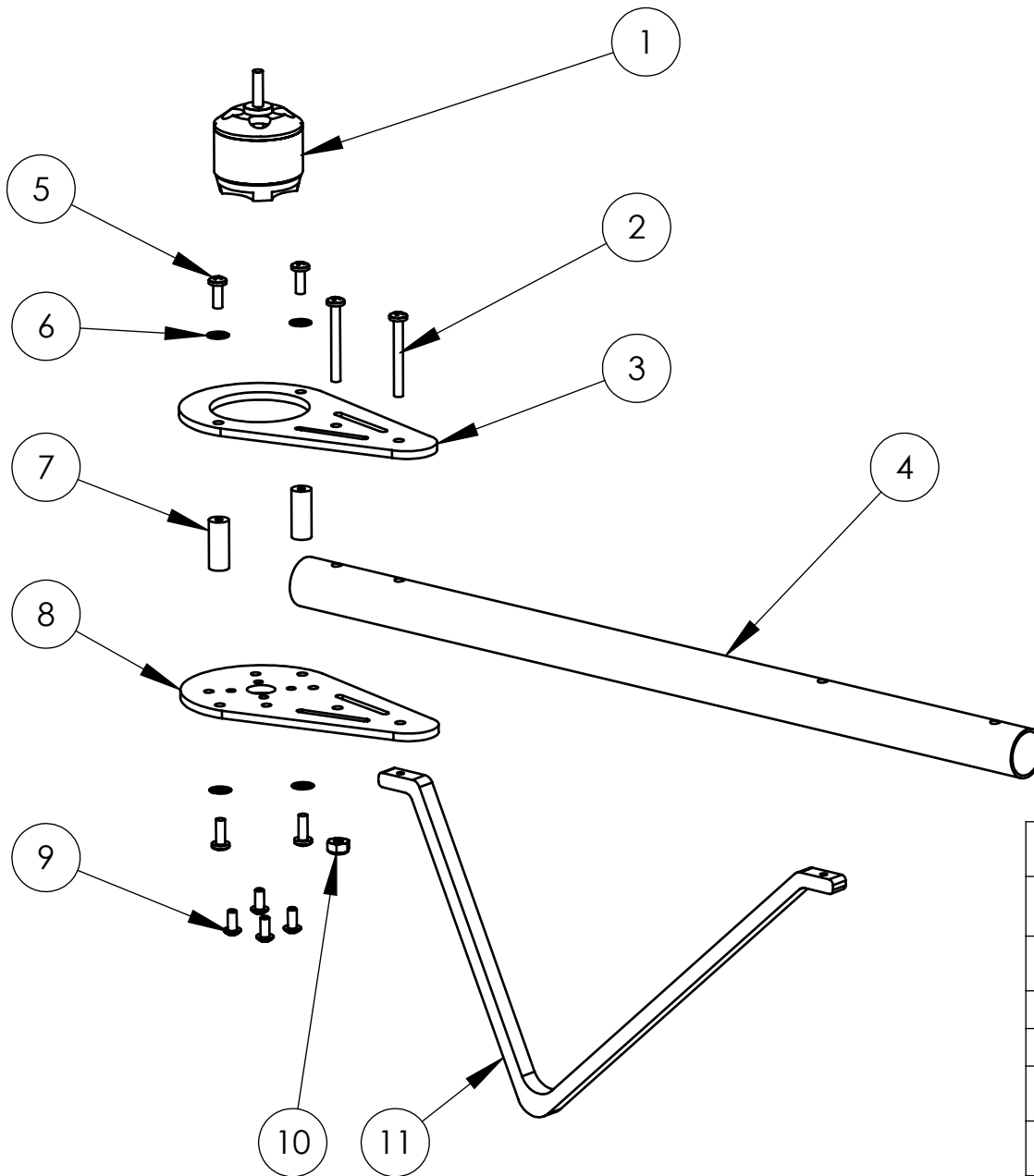

ITEM NO.	PART NUMBER	QTY.
1	Motor Assembly	1
2	1" Screw Pan head, Stainless Steel	2
3	Motor Mount top	1
4	Boom Arm Black	1
5	3/8" Screw, Pan head, Stainless Steel	4
6	Internal Tooth Lock Washer #4	4
7	Nylon Standoff 4-40 x 5/8	2
8	Motor Mount Bottom	1
9	Screw, 3mm x 6mm, 0.5 thread	4
10	Lock Nut 4-40 x 1/4	1
11	Landing Gear	1

Step 5: Boom Accessories (optional but highly recommended)

Your ELEV-8 Quadcopter Kit comes with two options for accessorizing the Booms: checkered tape and adhesive-backed LED light strips. You can apply either, both, or none to the Booms.

Many people choose to put white LED strips and black/white tape on the front Booms, and red LED strips and red/white tape on the back Booms. This makes it easy to identify the front and back of the quadcopter during flight. If you wish to use both, apply the checkered tape before applying the LED light strips.

1. Cut each sheet of checkered tape in half lengthwise to make four pieces. Apply a piece of tape around each Boom. This will make two red/white Booms and two black/white Booms.
2. Locate the black and red 22 AWG wires in the ELEV-8 Electronics Kit. Cut each 22 AWG wire into two pieces approximately 8 inches (20 cm) long, and then strip 1/4 inch (0.6 cm) of insulation from each end. You will have four black leads and four red leads for your LED tapes.
3. Locate the two LED tape strips. The yellowish LEDs shine white, and the clear LEDs shine red. Cut each strip in half along the solid black line.
4. Each LED tape section has tiny (+) and (-) contacts on one end. Solder a red 22 AWG lead to each (+) contact and solder a black 22 AWG lead to each (-) contact.
5. Peel the backing off of an LED tape section and position it along the underside of a Boom (over the checkered tape), with the wires pointing away from the motor.
6. Measure and cut four pieces of 3/4" clear heat-shrink tubing, each 4.5 inches (11.5 cm) long.
7. Slip the heat-shrink tubing over each Boom to cover the LED strip and its solder joints, and apply heat to shrink it in place.

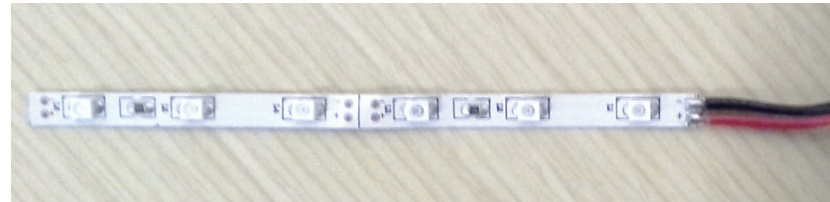
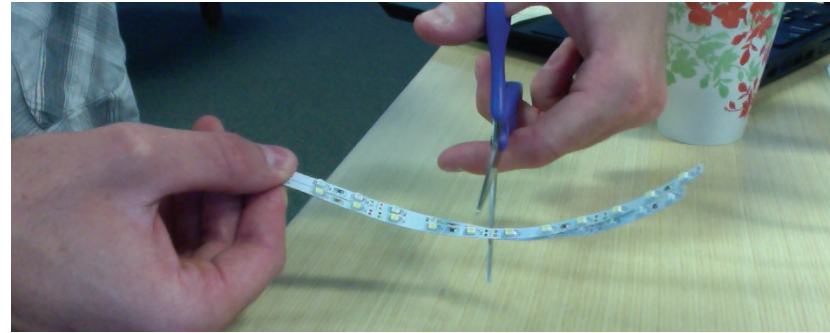

Step 6: Attach Motor/Boom Assemblies to the Bottom Chassis Plate

In this step, you will attach each Motor/Boom assembly to the Bottom Chassis Plate. (This kit comes with two identical Quad Chassis Plates. You will use one in this step, and the other one as a Top Chassis Plate in a later step.)

1. Refer to the diagram on the next page for the items needed from your ELEV-8 Airframe and Hardware kits.
2. Locate the correct mounting holes in the Bottom Chassis Plate to use for the Motor/Boom assemblies.
3. Position a Motor/Boom assembly (item 2) on the Bottom Chassis Plate (item 3). The Boom tube rests on top of the plate with the motor axle pointing upward, and the LED tape facing downward. The free end of the Landing Gear leg slips underneath the plate.
4. Thread a 1-1/4" long Panhead Screw (item 5) through the end of the Landing Gear's longer leg, through the underside of the Chassis Plate (item 3) and through the Boom tube (item 2). Secure it in place with a threaded 5/8" Nylon Standoff (item 1).
5. Thread a 1" long Panhead Screw (item 4) through the underside of the Chassis Plate (item 3), and then through the last hole in the Boom (item 2). Secure it in place with a threaded 5/8" Nylon Standoff (item 1).
6. Repeat until all four Motor/Boom assemblies are attached to the Bottom Chassis Plate.

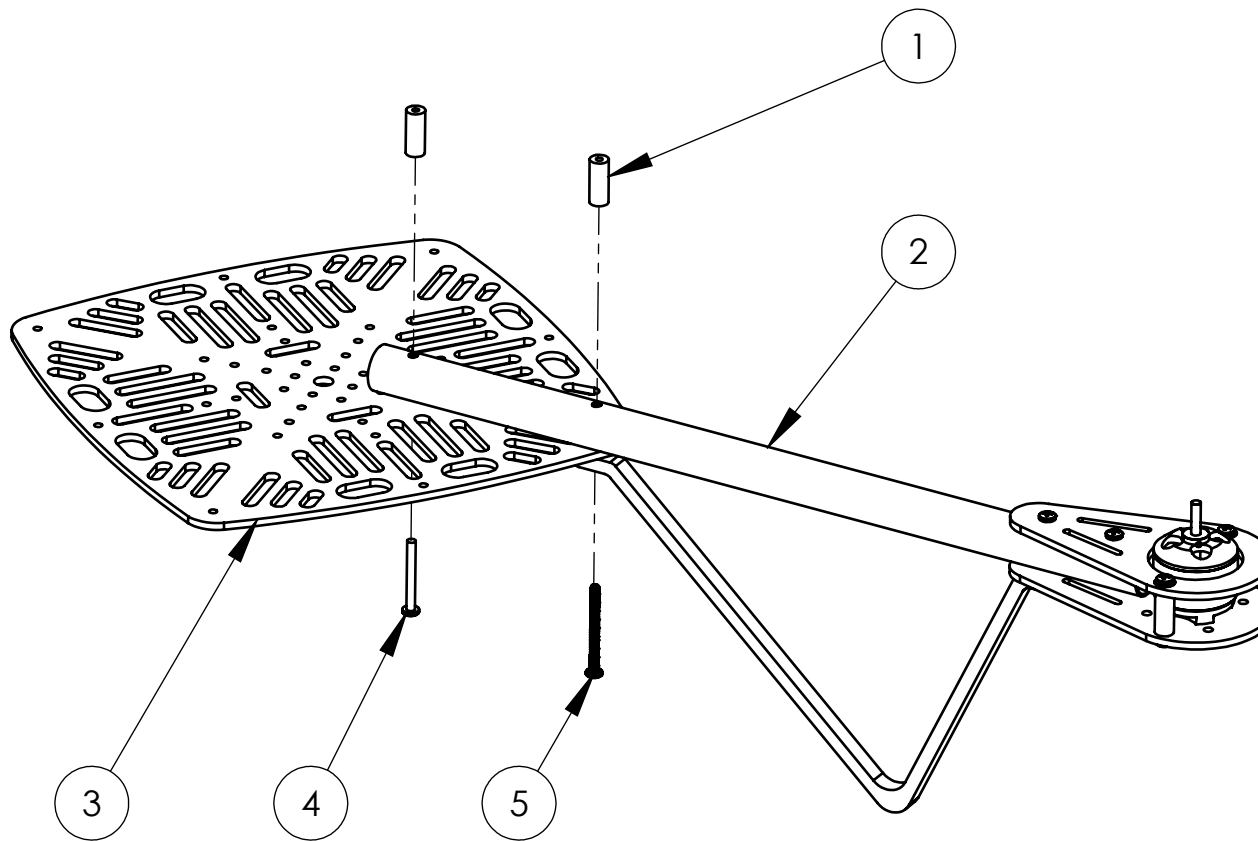

ITEM NO.	PART NUMBER	QTY.
1	Stand off, Nylon, 5/8", 4-40 screw size	2
2	Assy Boom Arm	1
3	Quad Chassis	1
4	Screw 4-40, 1-1/4" pandhead, ss steel	1
5	Screw, 4-40, 1-1/4", panhead, SS steel	1

Step 7: Solder the Power Harness Together

In this step, you will solder together your ELEV-8 quadcopter's power harness. It will provide the connection between the battery pack and the ESCs (and LED tapes if you are using them).

1. Find the black and red 12 AWG wires in your ELEV-8 Electronic Kit; these will be the power harness leads. Strip 1/4 inch of insulation off one end of each wire.
2. Solder all the ESC speed controllers' red leads to the single 12 AWG red lead, ends-to-end. Likewise, solder all of the ESC's black leads to the single 12 AWG black lead, ends-to-end as shown in the picture at right, top.
3. Cut two 1-1/2-inch lengths of 1/2" black tubing. Slip a piece of tubing **past** each of the two solder joints you just made on the power harness so that they sit closest to the ESCs. **Don't shrink them yet**, just keep them out of the way of the solder joints.
4. Position the power harness inside the ELEV-8 chassis bottom, but do not secure it in place yet. The recommended layout is shown on the following page.
5. If you are using LED tapes, bundle together all of their red leads. Align these thinner wires alongside the red 12 AWG wire in the opposite direction from the ESCs' wires and solder them into place, as shown at right, middle. This will make a neater package for the heat-shrink tubing.
6. Likewise, solder the LED tapes' black leads to the solder joint where all the other black leads meet on the power harness.
7. Slide the heat shrink tubing back up and over each solder joint. Apply heat with a heat gun or hair dryer to shrink the tubing into place, as shown at right, bottom.

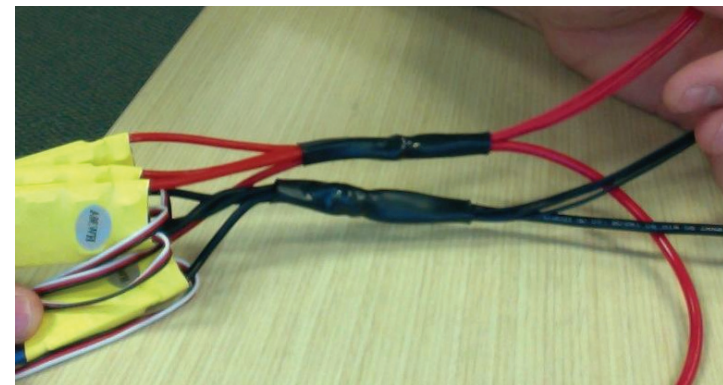
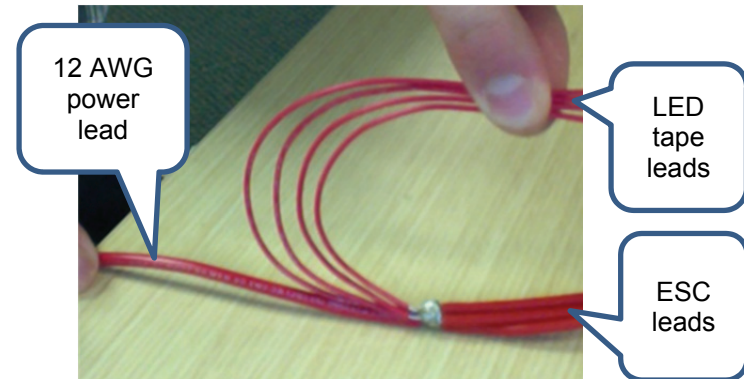
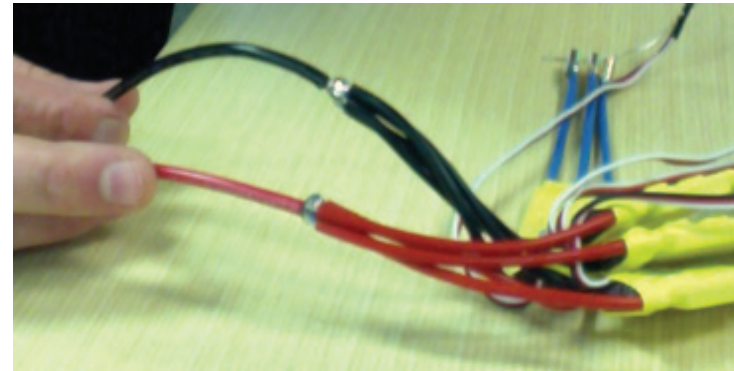

8. Decide how long to trim the 12 AWG power harness leads. If you use the layout shown below, and you will be strapping your batteries to the top of the chassis, you can trim the power harness leads to about 4 inches. If you are going to use a custom layout to accommodate extra electronics, decide how long to make the power harness leads. Trim the 12 AWG wires to the desired length, and then strip about 1/8 inch of insulation from the end of each one.
9. Locate the packet of gold bullet connectors and plastic housings in the ELEV-8 Electronics Kit. You will need two bullet connectors and one plastic housing.
10. Solder a bullet connector onto the end of each 12 AWG lead. Insert the exposed tip of the wire into the cup end of the bullet connector, and fill the cup with solder.
11. Insert the bullet connectors into the flattened end of the blue housing. The red lead goes into the "D" shaped side and the black lead goes into the "O" shaped side. It will take some force for the bullet connectors to click into place.

PRO TIP: We recommend using a flat-head screwdriver to hold the bullet connector in the housing and then use a hammer and tap the connector into place.
12. Reposition the power harness inside the ELEV-8 chassis bottom. Secure the ESC's in place with zip ties.
13. Connect the battery pack to the power harness. The LED tapes, if you are using them, should come on.

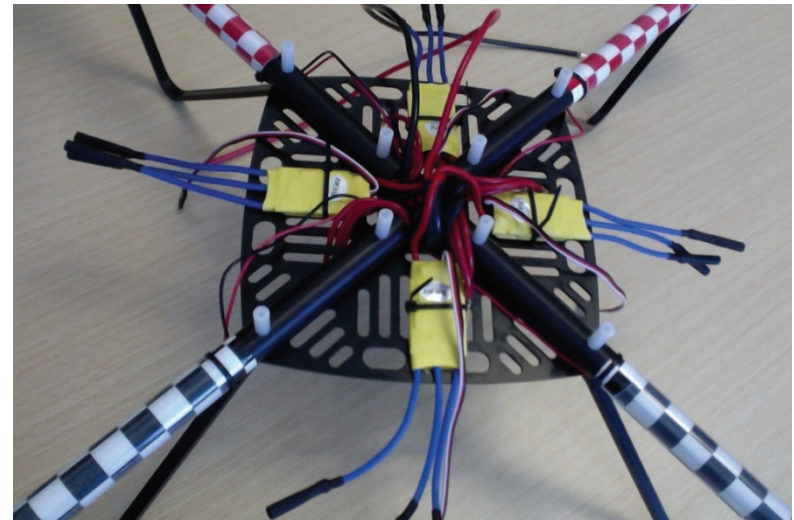
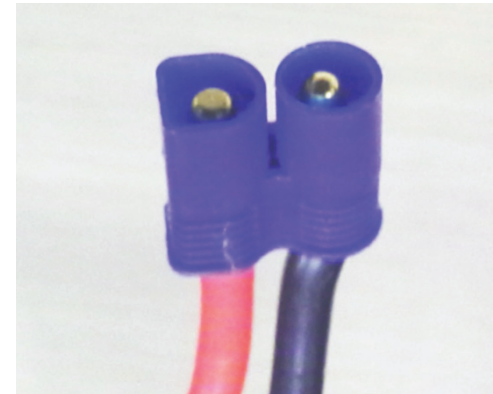

Step 8: Configure your Transmitter

1. For best results, follow the Transmitter Setting Recommendations in the table below to configure your Transmitter.
2. Refer to the diagram below to see how your Transmitter's 2-axis joystick controls will translate into ELEV-8 quadcopter motion with these settings.

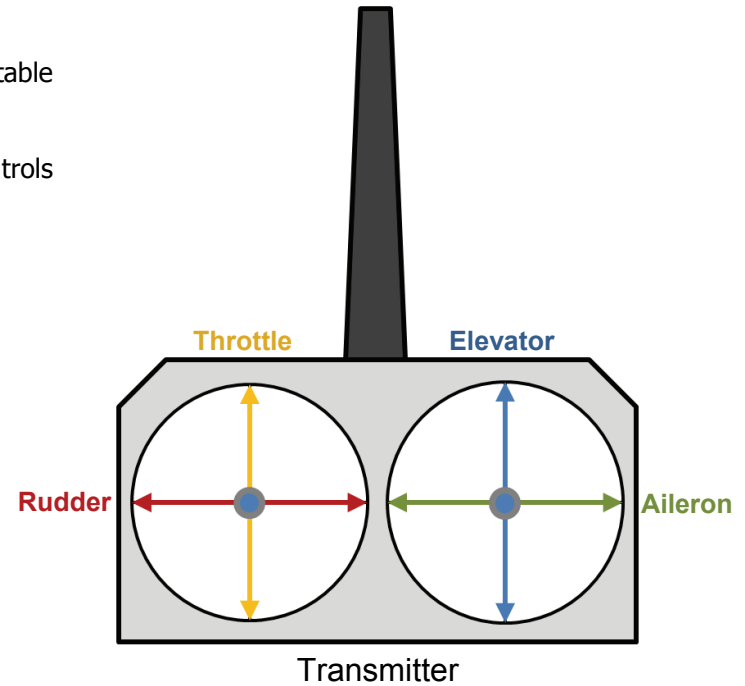
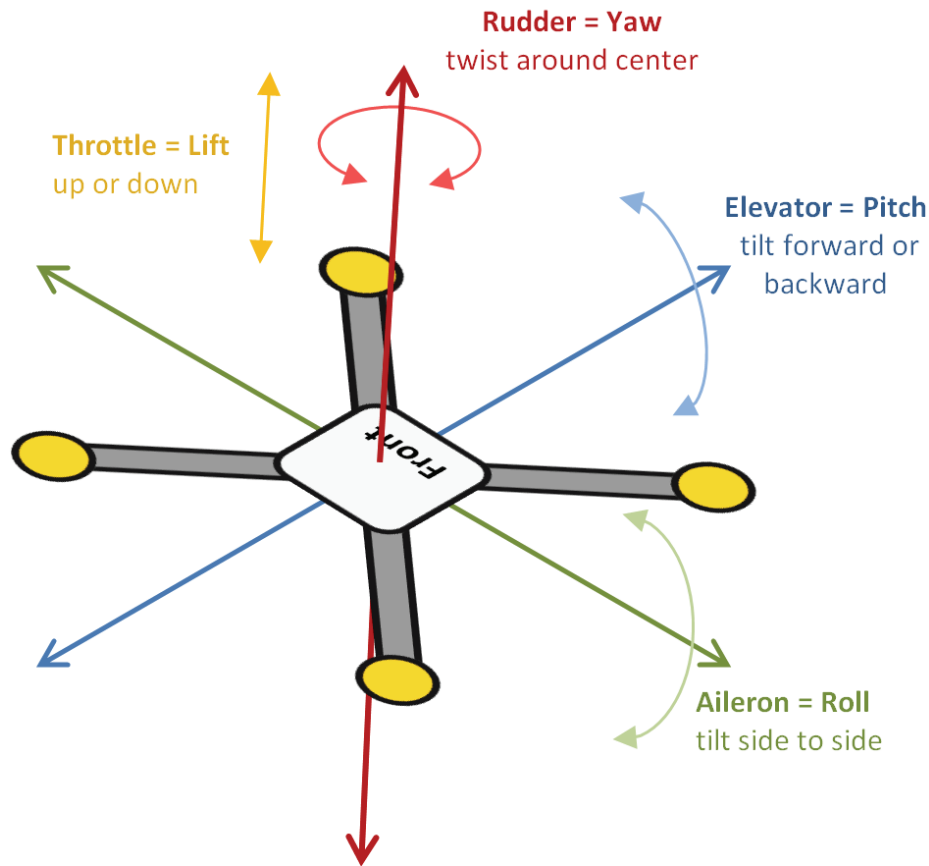

Transmitter Setting Recommendations	
Box Model Type	ACRO (Plane Mode)
End point adjustment	Set to 50% initially. (If the ELEV-8 still seems too reactive, reduce to 30% until you get used to flying it.)
Dual-Rates (D/R)	100%
Channel Reverse	Normal: Hi Tech Spektrum, JR brands Reversed: Futaba brand
Trims	Centered
Sub-trims	Centered
Gain Adjust	Set Gain on 5 th channel. Start with 25%, add or subtract based on flight stability
Exponential	After gaining experience, add up to 30% into aileron and elevator

Step 9: Programming the ESC Speed Controllers

In this step, you will program the motor’s electronic speed controllers (ESCs) with an ESC Programming Card. The ESCs should not be plugged into the motors yet. IF THE ESCs ARE PLUGGED INTO THE MOTORS, DISCONNECT THEM NOW.

Note: The ESC Programming Card was added to kits in April 2013. They are also available separately from www.parallax.com; search “85000”.

1. Connect your charged LiPo battery to the power harness.
2. Connect an ESC to the ESC programming card’s BEC port. Be sure to line up the black wire with (-), the red wire with (+), and the white wire with (Signal).

WARNING: Do not connect to the Programming Card’s BEC port and Batt port at the same time; this would damage the card.

3. Set the ESC card to the configuration shown in the picture and the table, then push OK to program the ESC. Repeat with each ESC, using the same settings. Be sure to cycle power between each programming cycle.

1	Brake	Off
2	Battery Type	Li-xx
3	Cut Off Type	Soft-cut*
4	Cut Off Voltage	Middle
5	Start Mode	Normal
6	Timing Mode	Middle
7	Music/Li-Po Cells	(none)
8	Governor Mode	Off

* Soft-cut (also called Reduce Power) lets you know when the quadcopter’s batteries are running low. If you set this to Cut-off/Shut Down, your quadcopter will simply fall out of the sky when it reaches a certain battery level.

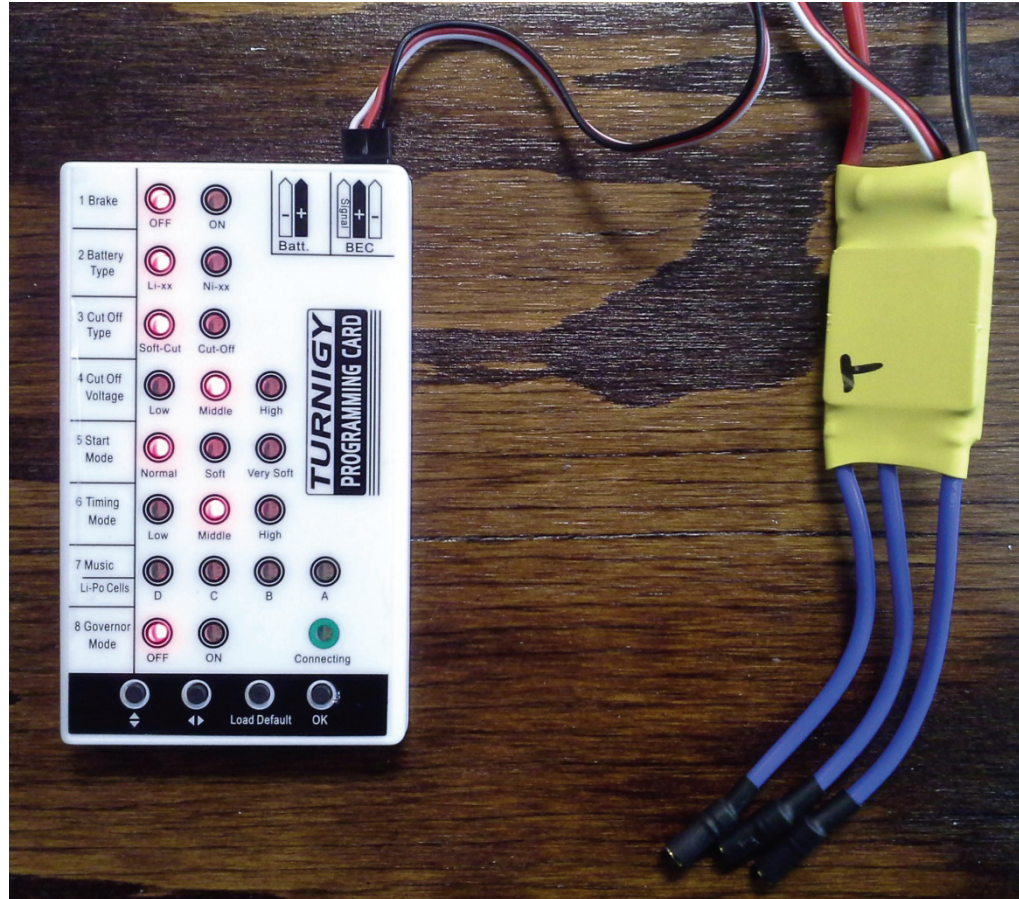

Step 10: Connect the Motors and Synchronize the ESCs

After programming the electronic speed controllers, it is time to connect each one to its motor and test it to make sure it is turning in the proper direction. For this step, your Receiver will temporarily connect directly to (and receive power through) each ESC.

WARNING: Do not connect a battery or other power source and an ESC to your receiver at the same time. If you do, you will permanently and catastrophically damage both the ESC and Receiver.

STOP: YOU SHOULD NOT HAVE PROPELLER BLADES ON YOUR MOTORS YET! IF YOU DO, REMOVE THEM NOW.

1. If you have not done so already, bind your Transmitter to your Receiver as per your RC controller's instruction manual.
2. Identify which edge of the chassis will be the front of your ELEV-8 quadcopter. If you have used the checkered stickers and/or the LED tapes, the front edge would be between the two black-checkered, white-LED Booms.
3. Put a piece of tape on the output shaft of each motor, so you can easily tell the direction of rotation.
4. Connect an ESC's 3-pin socket to the Throttle port on your Receiver.
5. Gently apply the throttle to see which direction the motor turns. Refer to the diagram to see which direction each motor needs to turn.
6. If the motor is not turning the proper direction, disconnect any two of its leads, reverse them, and reconnect.
7. Label the ESC with its motor position number, both on its case and on its 3-pin socket.
8. Repeat with each ESC until all motors are turning in the correct direction and each ESC case and lead are numbered.
9. When you are sure your motor connections are all correct, apply heat to finish shrinking the tubing over the motor/ESC connector joints.
10. To synchronize your ESCs, power on the ELEV-8 quadcopter. Turn on your transmitter, then set Throttle to max position. After the standard startup sequence, two separate beeps will indicate the max throttle position has been set and stored. Lower throttle to min position. You will hear three beeps, which indicate that min throttle position has been set and stored.

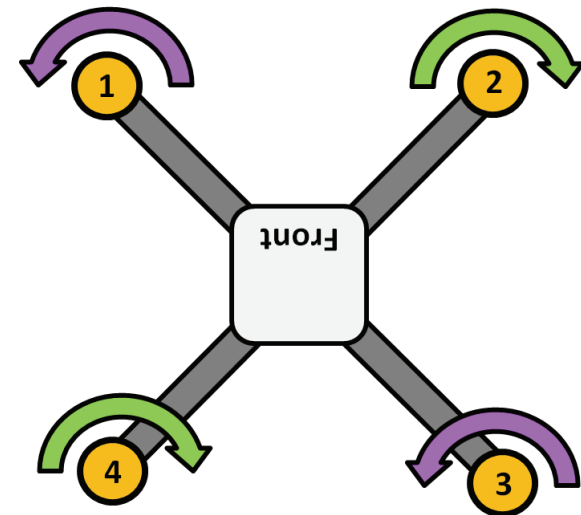

Step 11: Chassis Top Plate and Control Board Assemblies

In this step, you will prepare and attach the Chassis Top Plate. Then, you prepare and attach the Control Board to its Mount plate.

Gather the items shown in the diagrams on the next two pages.
Note: the Control Board Mount Plate has slots around all four edges.

1. Pull all the ESCs' 3-pin leads together towards the front of the chassis.
2. Referring to the diagram on the next page, locate the correct holes in the Top Chassis Plate (item 2) to attach the four 1-1/4" Nylon Standoffs (item 1).
3. Attach each Nylon Standoff (item 1) to the top of the Top Chassis Plate (item 2) with a 3/8" Panhead Screw (item 3).
4. Attach the Top Chassis Plate to the standoffs on top the Booms using 1/4" Black Panhead Screws. There will be two screws required for each Boom.
5. Refer to the diagram on page 21. Rubber grommets are included with the Control Board. Insert a Rubber Grommet (item 3) into the large mounting hole on each corner of the Control Board (item 4). These grommets reduce vibrations transferred to the Control Board during flight.
6. Insert each 3/8" Panhead Screw (item 1) through a Washer (item 2), then through an installed Grommet, and into the Control Board Mount Plate (item 5). The screws are self-tapping into the Mount Plate, so only gently hand-tighten to avoid stripping the hole.

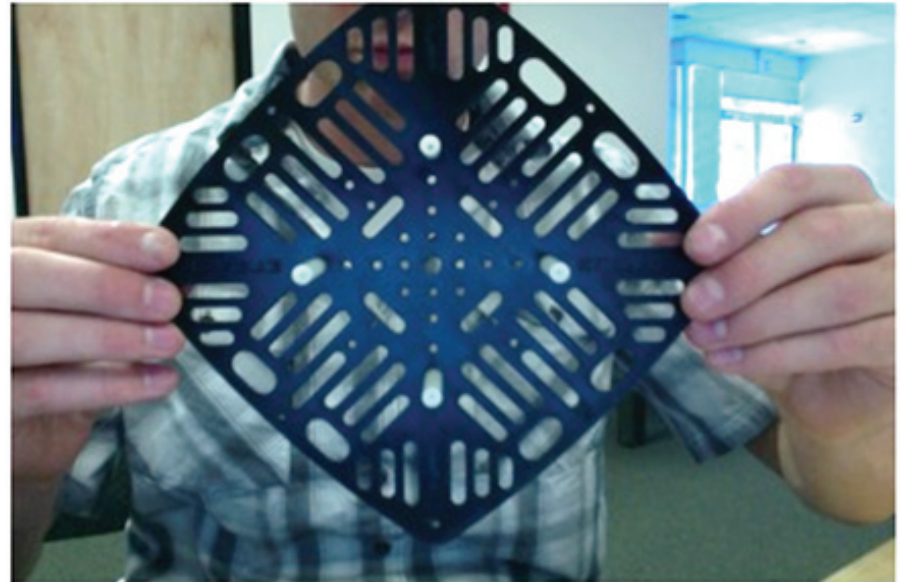

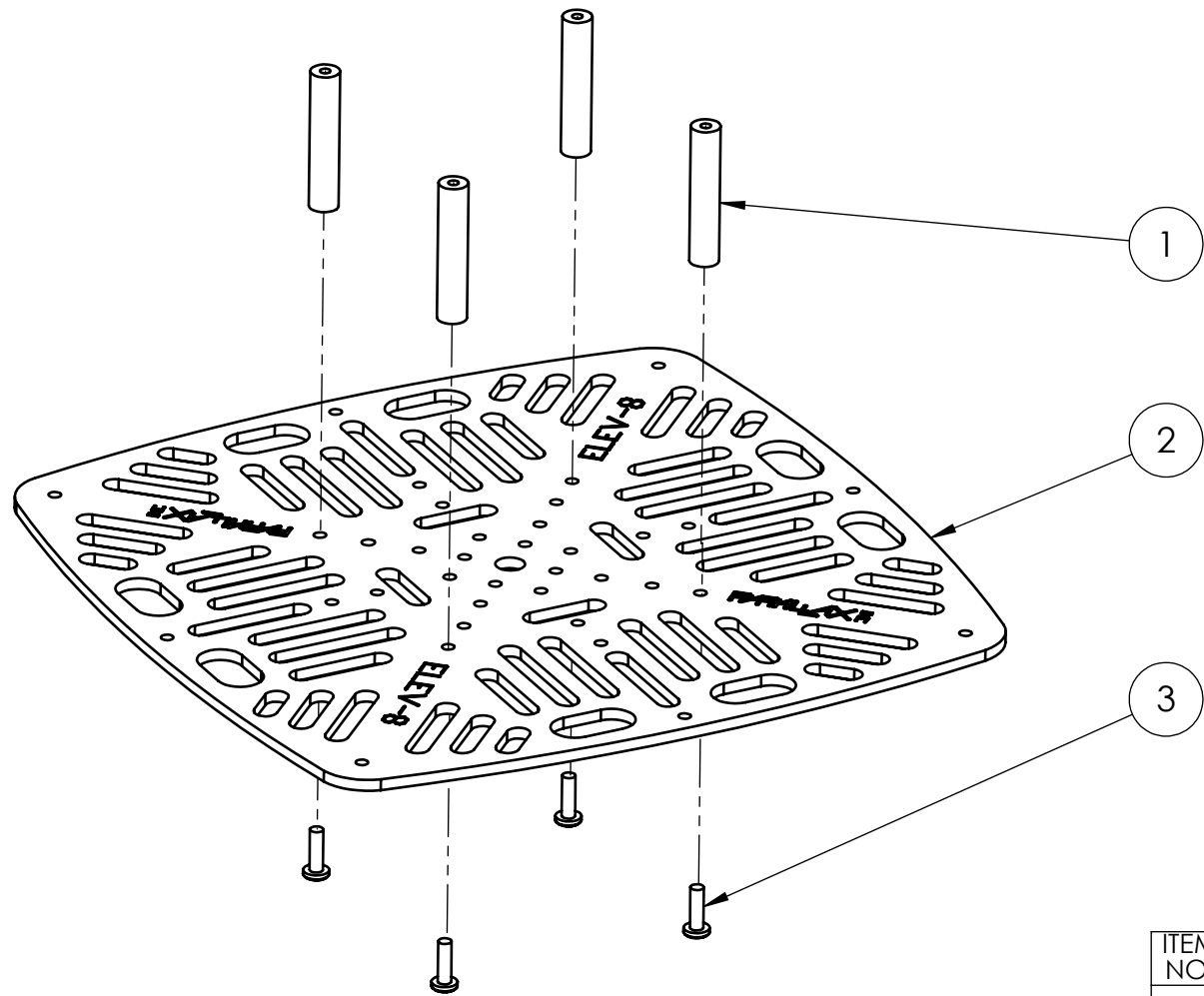

ITEM NO.	Description	QTY.
1	Stand off nylon, 1-1/4", Thread	4
2	Quad Chassis	1
3	Screw 4-40 3/8 Panhead stainless steel	4

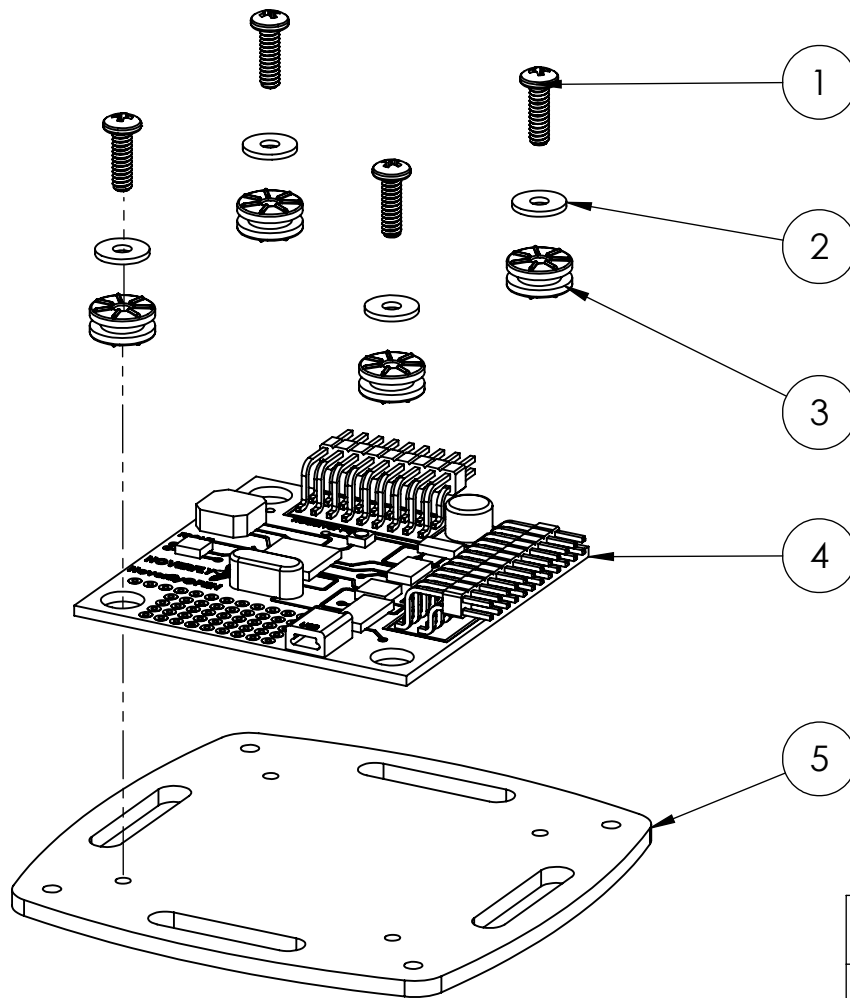

ITEM NO.	Description	Part Number	QTY.
1	Screw, 4-40, 3/8", panhead, stainless steel	710-00036	4
2	# 4 SS Steel Washer		4
3	Rubber Grommet		4
4	HoverFly Open PC Board		1
5	ELEV-8 Control Board Mount Plate Assy	721-80002	1

Step 12: Mount the Control Board Assembly onto the Chassis

In this step, you will enclose the Control Board within its protective Top Plate, and then mount the Control Board Assembly onto the completed ELEV-8 quadcopter chassis.

1. Gather the items listed in the diagram on the next page.
2. Find the arrow on the Control Board silkscreen, as shown in the picture. This arrow points to the front of the Control Board, which must be facing the same direction as the front of the ELEV-8 chassis.
3. Set the Control Board Assembly over the standoffs in the Top Chassis Plate. Make sure the front of the Control Board is aligned with the front of the Chassis.
4. Align the Control Board Top Plate over the Control Board. The small hole near the center of the Control Board Top Plate is for a light pipe. Make sure this hole is directly above the LED on the Control Board. This will make light from the LED visible when the Top Plate is in place.
5. Thread each 1" Panhead Screw (item 2) through a corner hole in the Control Board Top Plate (item 3), then through a 1/2" Nylon Spacer (item 4), through a corner hole in the Control Board Assembly (item 5), and finally into a standoff on top of the Chassis (item 6). Gently tighten.
6. Insert the Light Pipe (item 1) into its hole in the Control Board Top Plate (item 3), until it touches the LED underneath. Trim the Light Pipe to length.
7. Slip your battery between the Control Board Mount Plate and the Chassis Top Plate, and secure it in place with the Nylon Straps.
8. Mount your Receiver to the chassis with zip-ties, referring to its documentation for best placement recommendations.

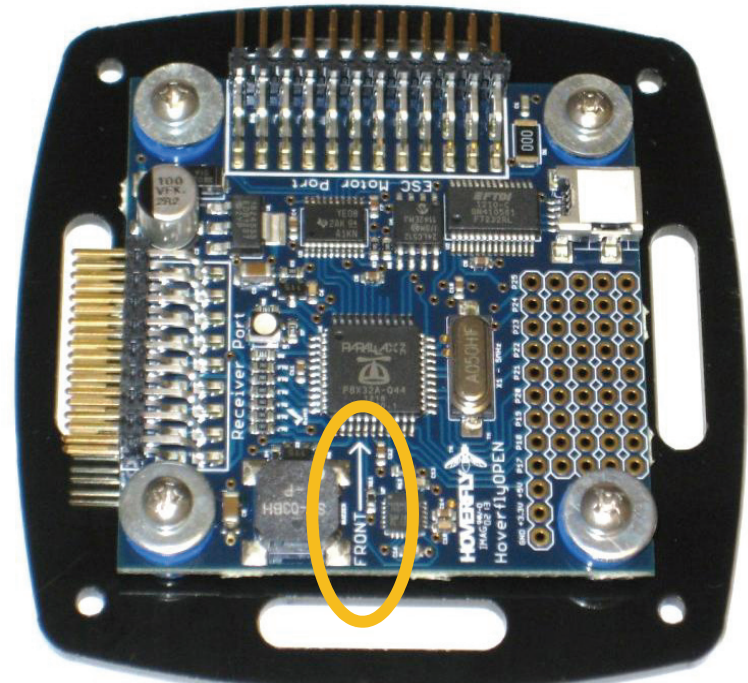

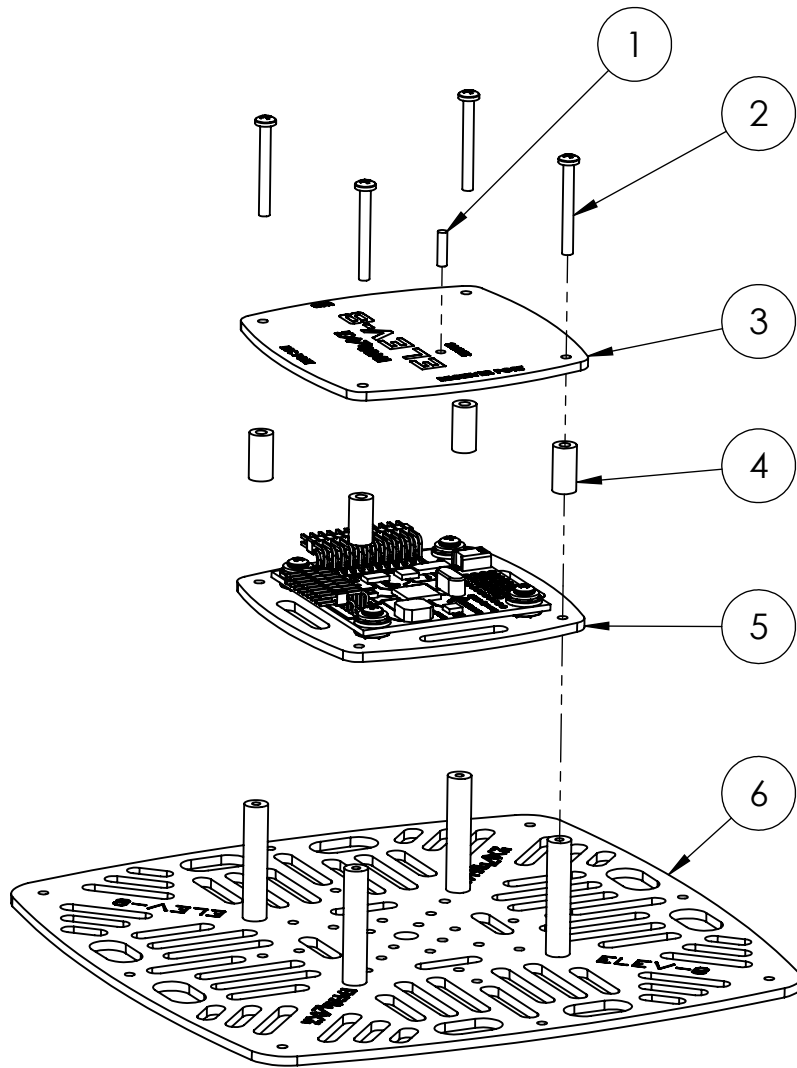

Note: #5, Light Tube comes 5/8" long.
Cut to length needed

ITEM NO.	PART NUMBER	QTY.
1	light tube	1
2	Screw, 4-40 x 1" Pandhead SS Steel	4
3	ELEV-8 Control Board Top Plate	1
4	Spacer, Nylon, 1/2", 4-40 screw size	4
5	Ass'y PC Board HoverFly Open	1
6	Quad Chassis	1

Step 13: Control Board Connections

In this step, you will connect your ESCs and Receiver to your Control Board. The Receiver connects to the Receiver Port's 2x9 male header on the left edge of the Control Board. The electronic speed controllers connect to the ESC Port's 2x12 male header on the front edge of the Control Board.

1. Connect the Receiver to the Receiver Port, with the five signal connections listed below. Use the 3-wire extension cables included in the ELEV-8 Electronics Kit.

A = Aileron
 T = Throttle
 R = Rudder
 E = Elevator
 G = Gear (ON: EPA value is Primary Gain, Altitude Hold is off.)
 (OFF: EPA value is Altitude Hold Gain, Altitude Hold is on.)

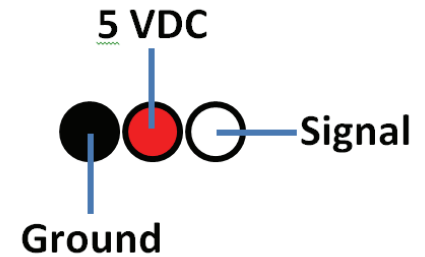

Receiver Port: Control Board Left Edge

2. Connect each motor's ESC controller to the corresponding pins on the ESC port. Match the motor numbers at left to the port numbers below.
3. Double-check your connections – it's easy to make a mistake here.



ESC Port: Control Board Front Edge

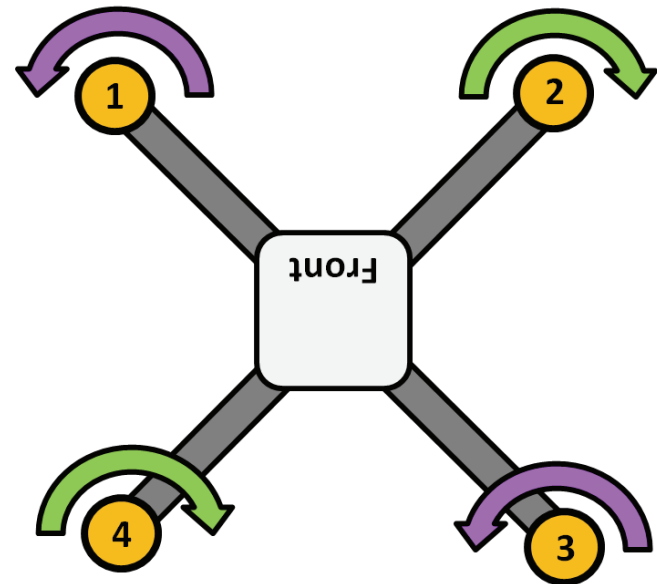

Step 14: Mounting the Propeller Blades

Only mount the propeller blades when you are ready to fly.

There are two different types of slow flyer propeller blades in the ELEV-8 Electronics Kit: Counterclockwise, (CCW, marked 1045) and Clockwise (CW, marked 1045R). The correct type of blade must be used on each motor for the ELEV-8 to fly. See the drawing below for label location; the blades are rounded-side-up.

1. Disconnect the battery from the Power Harness.
2. Refer to the diagram on this page for the correct placement of each blade.
3. Connect each blade to its motor, referring to the diagram on the next page. The Blade (item 2) should be mounted rounded-side-up, seated on a Cone Lock (item 3) over a Collet (item 4).
4. Finger-tighten the Propeller Nut (item 1), then use an Allen wrench to tighten $\frac{1}{4}$ turn more.

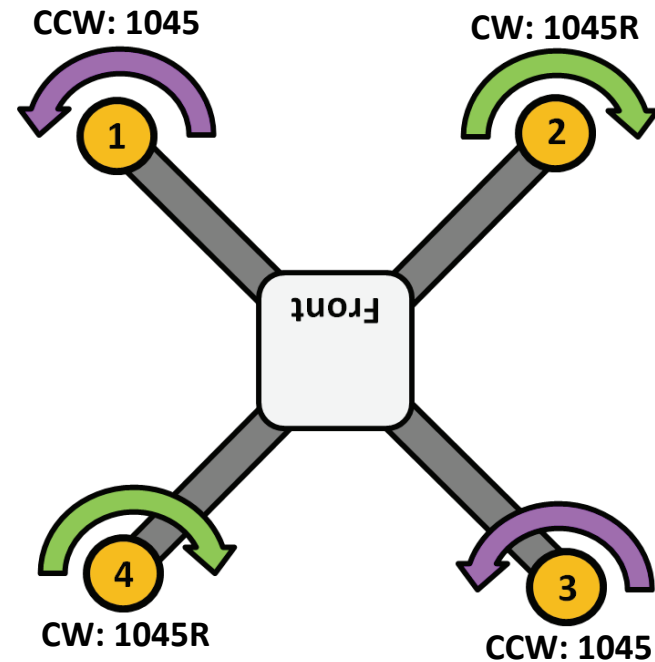
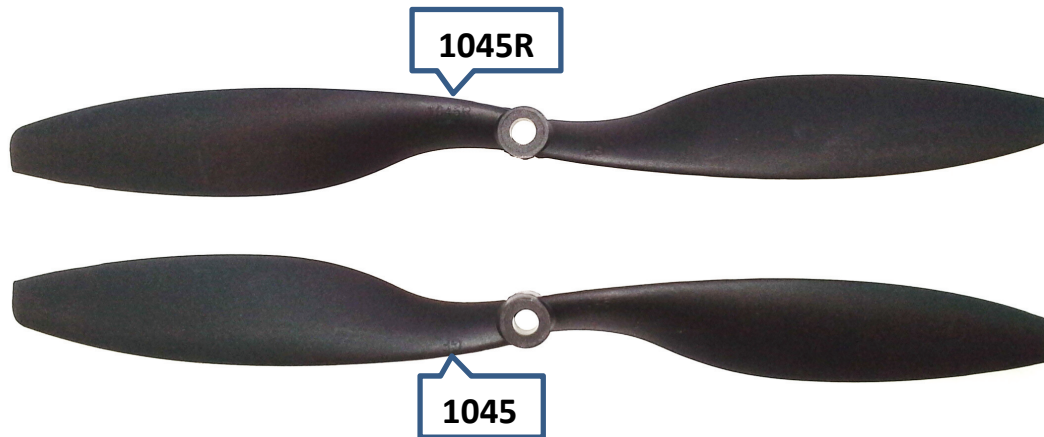

Congratulations! Your assembled ELEV-8 Quadcopter is ready to fly. For a "First Flight" video and troubleshooting tips, see the ELEV-8 Quadcopter product page; go to www.parallax.com and search "80000".

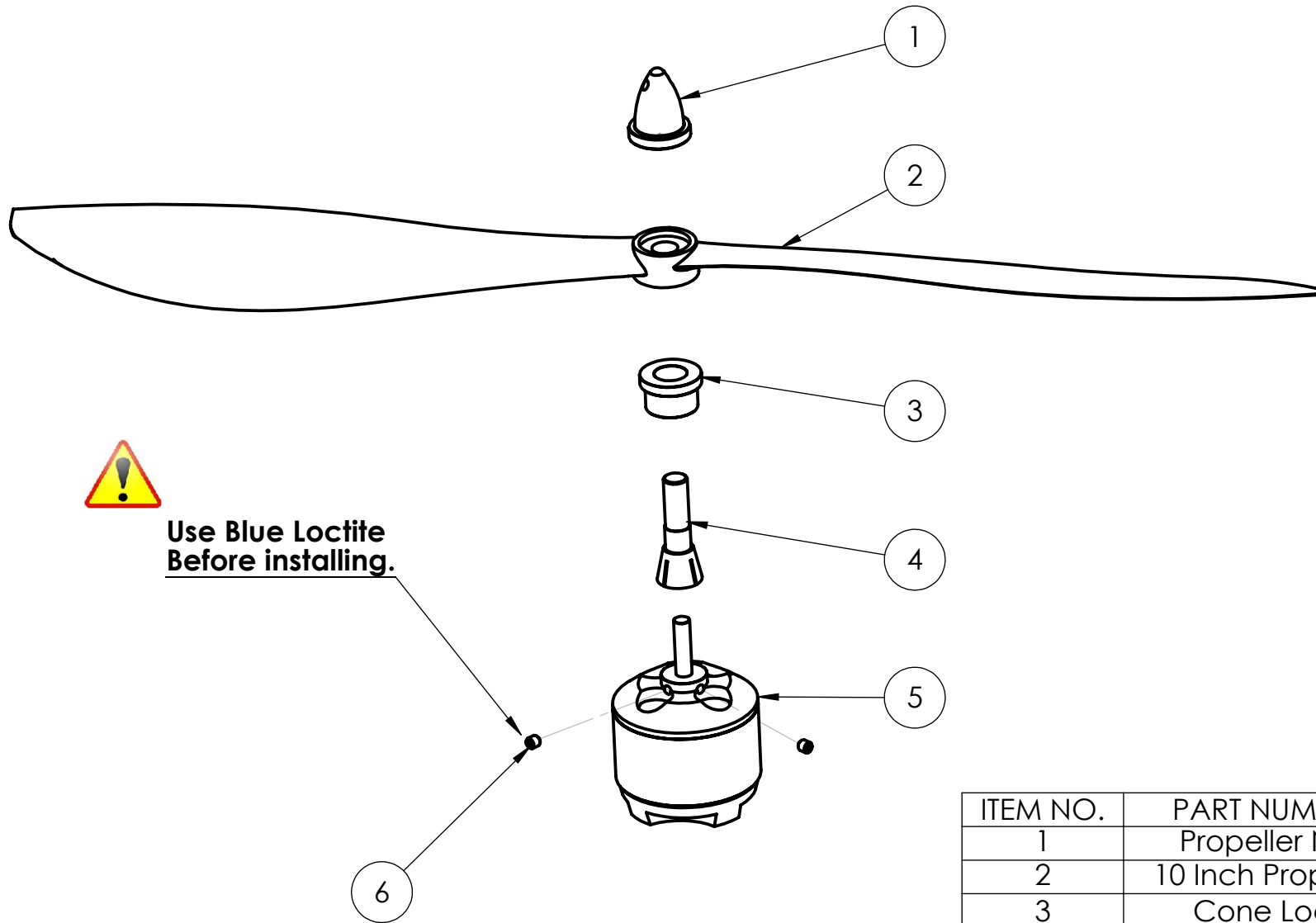

ITEM NO.	PART NUMBER	QTY.
1	Propeller Nut	1
2	10 Inch Propeller	1
3	Cone Lock	1
4	Collet	1
5	Motor 2	1
6	Set Screw	2