

SERPAC 2003, DB9 for A20

Electronic Enclosures

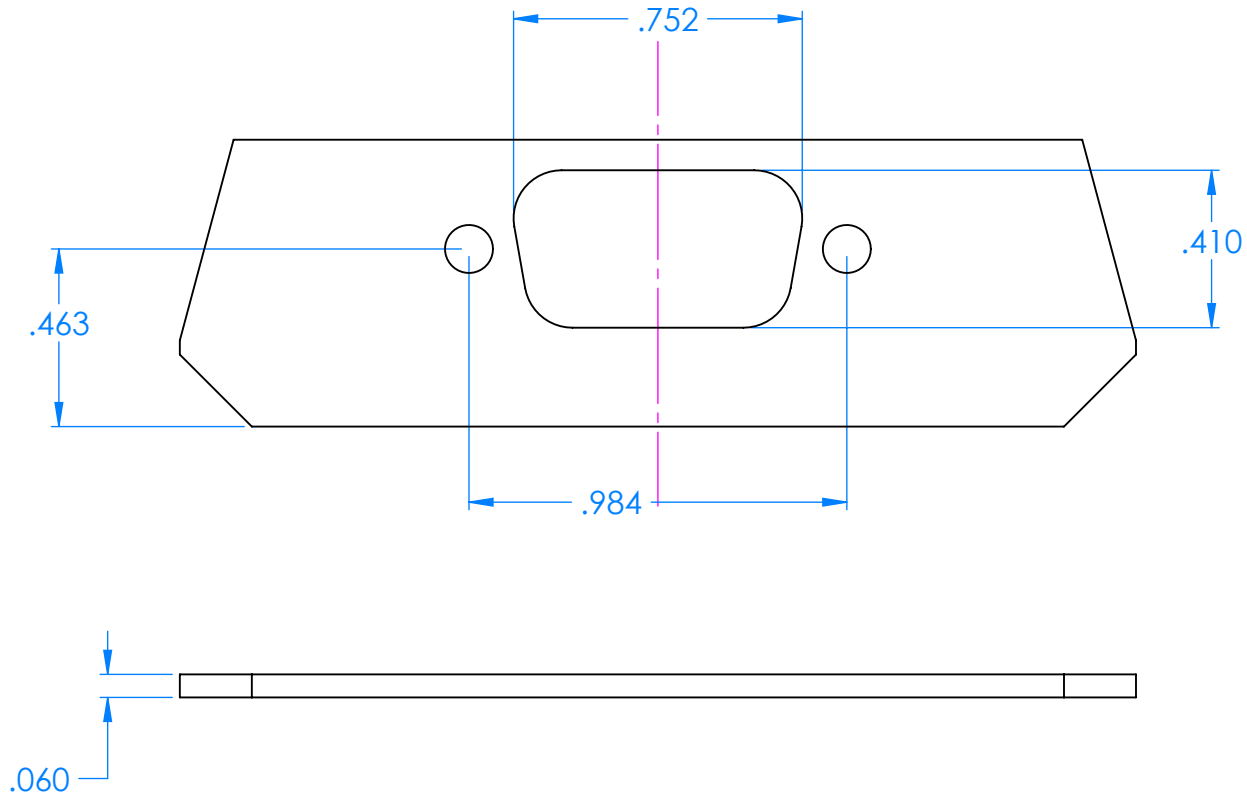

NOTES:

Cutout located to accept a D-sub standard surface mount DB9 connector (male or female) using a .065" thick circuit board.