

FS5700 SERIES PUSHBUTTON SWITCH

ANTI-VANDAL SWITCHES
DETECTOR SWITCHES
DIP SWITCHES
KEYLOCK SWITCHES
NAVIGATION SWITCHES
PUSHBUTTON SWITCHES
ROCKER SWITCHES
ROTARY SWITCHES
SLIDE SWITCHES
SNAP ACTION SWITCHES
TACTILE SWITCHES
TOGGLE SWITCHES
CAP OPTIONS

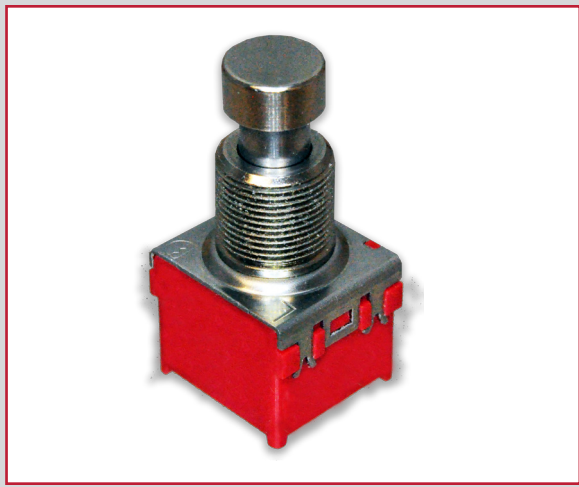

APPLICATIONS / MARKETS



Gaming: Flight Simulation



Home Appliances



Floor Care Appliances



Industrial Controls



Medical / Dental



Foot Switch

RoHS

SPECIFICATIONS

Contact Rating: 1A @ 9VDC
Electrical Life: 30,000 Cycles
Contact Resistance: 50mΩ Initial
Insulation Resistance: 100MΩ @ 500VDC
Dielectric Strength: 1000V RMS
Operating Temperature: -10°C to 70°C
Storage Temperature: -10°C to 70°C
Full Travel: SP & DP: 2.7mm; 3P: 5.0mm
Contact Arrangement: SPDT, DPDT or 3PDT
Actuation Force: Single pole momentary: 1700gf
 Single pole alternate action: 1000gf
 Double pole momentary: 2500gf
 Double pole alternate action: 1600gf
 3 pole alternate action: 3000gf
Panel Thickness: 8mm Max.

FEATURES & BENEFITS

- SPDT, DPDT or 3PDT
- Momentary or alternate action functions
- High actuation force
- PCB mount or panel mount option

PART NUMBER CONFIGURATOR

Series	Circuit	Function	Actuator	Bushing	Terminal	Contact Material	Sealing	Hardware
<input type="text" value="FS5700"/>	<input type="text" value="SP"/> SP - Single Pole <input type="text" value="DP"/> DP - Double Pole <input type="text" value="3P"/> 3P* - 3 Pole	<input type="text" value="L"/> L - Alternate Action <input type="text" value="M"/> M - Momentary	<input type="text" value="T2"/> T2 - 10mm dia.	<input type="text" value="B2"/> B2 - 11.5 high	<input type="text" value="M1"/> M1 - Solder Lug <input type="text" value="M2"/> M2 - PCB Pins	<input type="text" value="Q"/> Q - Silver	<input type="text" value="E"/> E - Epoxy	<input type="text" value="H"/> H** - Hardware

*3P only available in "L" function
 **Hardware only provided with "M1" termination

Specifications subject to change without notice



E-SWITCH®

www.e-switch.com

800.867.2717

1

FS5700 SERIES PUSHBUTTON SWITCH

SINGLE POLE

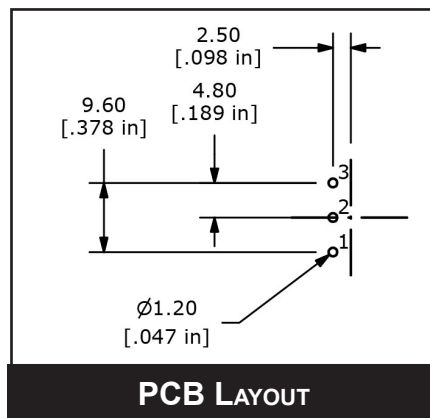
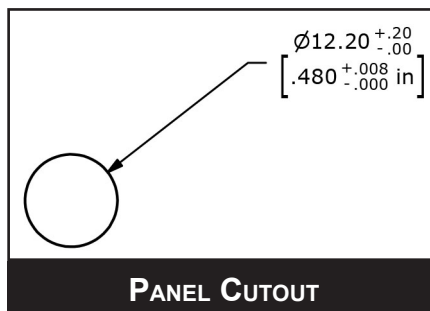
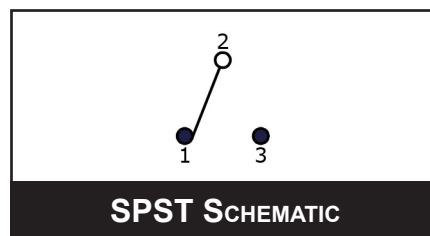
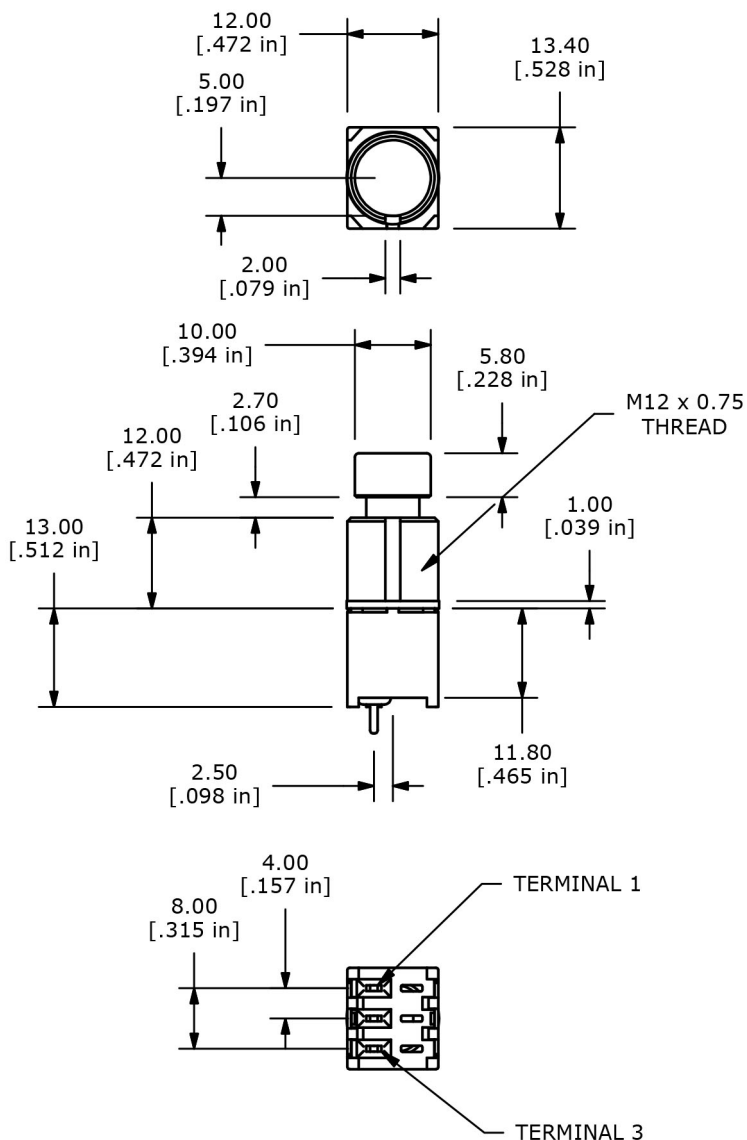

- ANTI-VANDAL SWITCHES
- DETECTOR SWITCHES
- DIP SWITCHES
- KEYLOCK SWITCHES
- NAVIGATION SWITCHES
- PUSHBUTTON SWITCHES**
- ROCKER SWITCHES
- ROTARY SWITCHES
- SLIDE SWITCHES
- SNAP ACTION SWITCHES
- TACTILE SWITCHES
- TOGGLE SWITCHES
- CAP OPTIONS



FS5700 SERIES PUSHBUTTON SWITCH

DOUBLE POLE

- ANTI-VANDAL SWITCHES
- DETECTOR SWITCHES
- DIP SWITCHES
- KEYLOCK SWITCHES
- NAVIGATION SWITCHES
- PUSHBUTTON SWITCHES**
- ROCKER SWITCHES
- ROTARY SWITCHES
- SLIDE SWITCHES
- SNAP ACTION SWITCHES
- TACTILE SWITCHES
- TOGGLE SWITCHES
- CAP OPTIONS

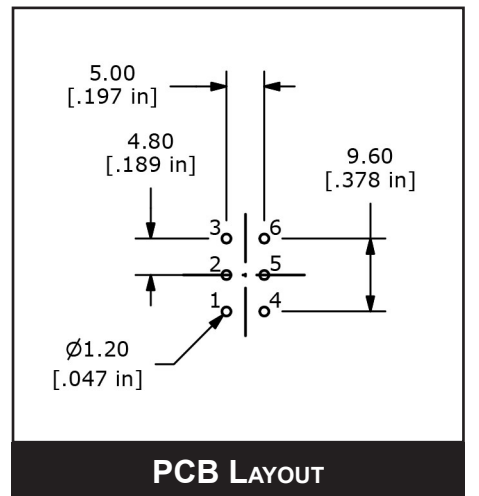
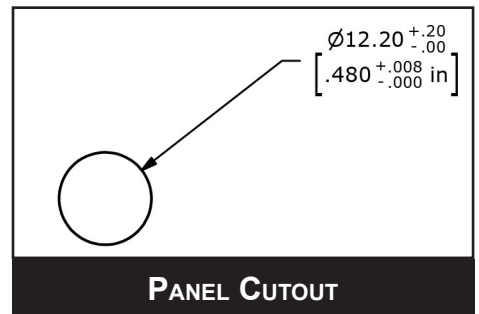
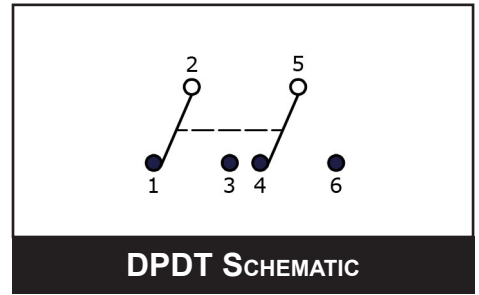
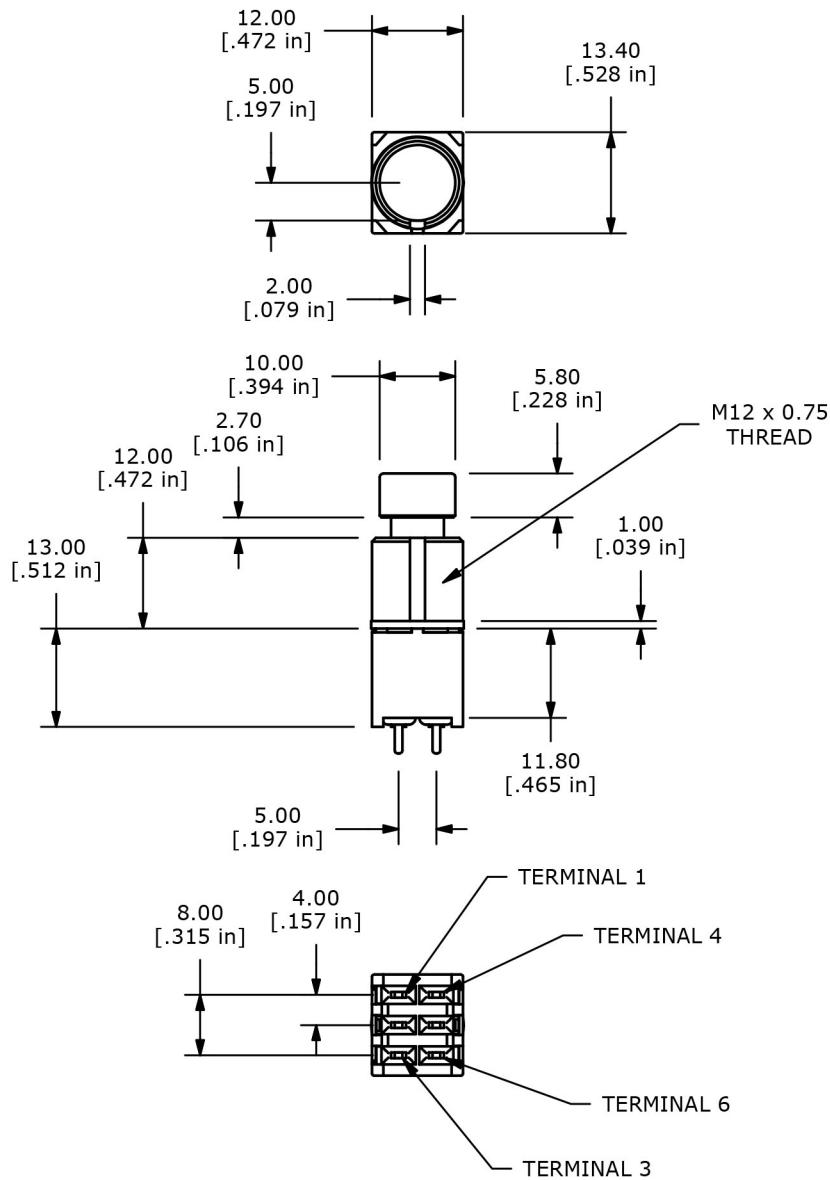

FS5700 SERIES PUSHBUTTON SWITCH

TRIPLE POLE

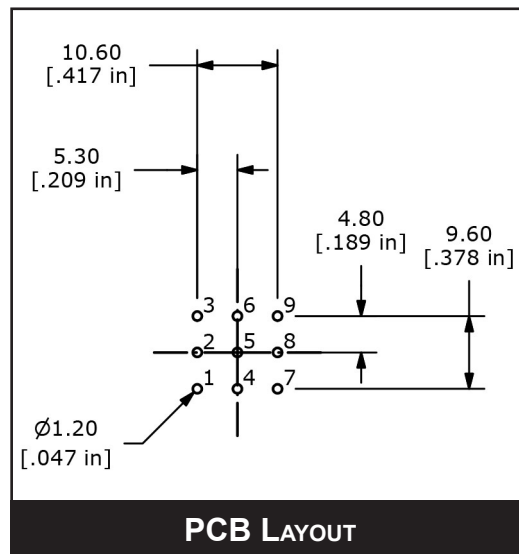
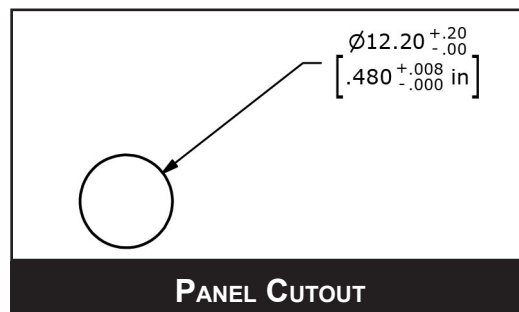
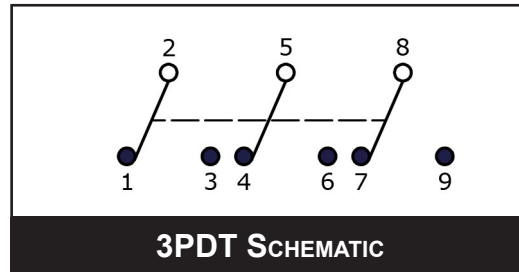
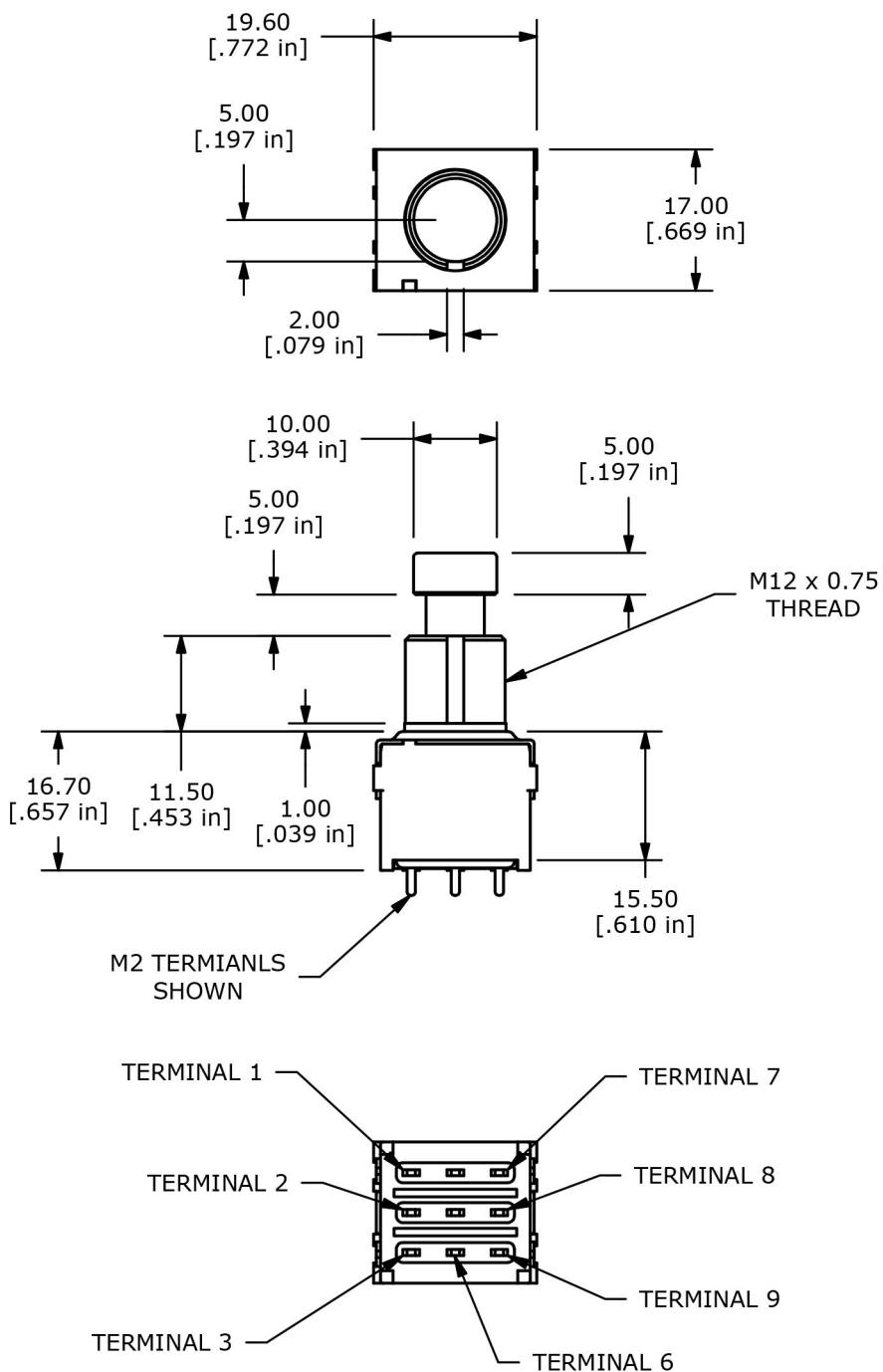

ANTI-VANDAL SWITCHES
 DETECTOR SWITCHES
 DIP SWITCHES
 KEYLOCK SWITCHES
 NAVIGATION SWITCHES
 PUSHBUTTON SWITCHES
 ROTARY SWITCHES
 ROTARY SWITCHES
 SLIDE SWITCHES
 SNAP ACTION SWITCHES
 TACTILE SWITCHES
 TOGGLE SWITCHES
 CAP OPTIONS

TERMINATION

M1 Termination

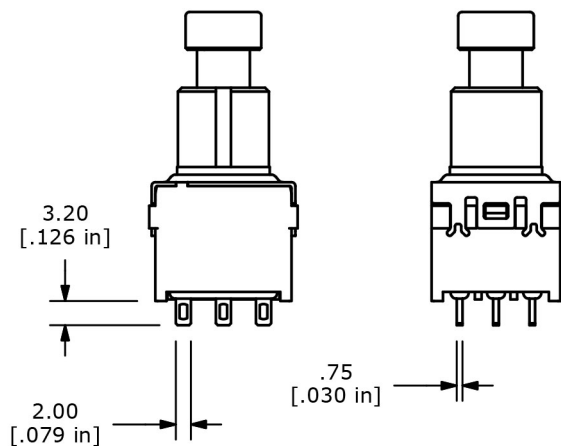

M2 Termination

