

SPEC

| | |
|----------|-----------------------|
| Spec No. | TQ3C-8EAF0-E1DEG38-01 |
| Date | May 27, 2009 |

TYPE : TCG057QVLCA-G00
< 5.7 inch QVGA transmissive color TFT
with LED backlight. >

CONTENTS

1. Application
2. Construction and outline
3. Mechanical specifications
4. Absolute maximum ratings
5. Electrical characteristics
6. Optical characteristics
7. Interface signals
8. Input timing characteristics
9. Backlight characteristics
10. Lot number identification
11. Warranty
12. Precautions for use
13. Reliability test data
14. Outline drawing

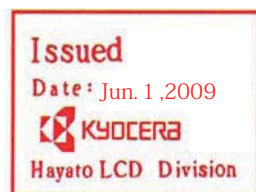

KYOCERA CORPORATION
KAGOSHIMA HAYATO PLANT
LCD DIVISION

This specification is subject to change without notice.
Consult Kyocera before ordering.

| Original Issue Date | Designed by: Engineering dept. | | | Confirmed by: QA dept. | |
|---------------------|--------------------------------|---------------------|---------------------|------------------------|---------------|
| | Prepared | Checked | Approved | Checked | Approved |
| February 19, 2009 | <i>y. Asano</i> | <i>T. Takahashi</i> | <i>Y. MATSUMOTO</i> | <i>J. Sakaguchi</i> | <i>T. Sak</i> |

| | | |
|-----------------------------------|-----------------------------|-----------|
| Spec No. TQ3C-8EAF0-E1DEG38-01 | Part No. TCG057QVLCA-G00 | Page - |
|-----------------------------------|-----------------------------|-----------|

Warning

1. This Kyocera LCD module has been specifically designed for use only in electronic devices and industrial machines in the area of audio control, office automation, industrial control, home appliances, etc. The module should not be used in applications where the highest level of safety and reliability are required and module failure or malfunction of such module results in physical harm or loss of life, as well as enormous damage or loss. Such fields of applications include, without limitation, medical, aerospace, communications infrastructure, atomic energy control. Kyocera expressly disclaims any and all liability resulting in any way to the use of the module in such applications.

2. Customer agrees to indemnify, defend and hold Kyocera harmless from and against any and all actions, claims, damages, liabilities, awards, costs, and expenses, including legal expenses, resulting from or arising out of Customer's use, or sale for use, or Kyocera modules in applications.

Caution

1. Kyocera shall have the right, which Customer hereby acknowledges, to immediately scrap or destroy tooling for Kyocera modules for which no Purchase Orders have been received from the Customer in a two-year period.

| | | |
|-----------------------------------|-----------------------------|-----------|
| Spec No. TQ3C-8EAF0-E1DEG38-01 | Part No. TCG057QVLCA-G00 | Page - |
|-----------------------------------|-----------------------------|-----------|

Revision record

| Date | | Designed by : Engineering dept. | | | Confirmed by : QA dept. | |
|--------------|--------------|---------------------------------|---|---------------------|-------------------------|----------------|
| | | Prepared | Checked | Approved | Checked | Approved |
| May 27, 2009 | | <i>Y. Asano</i> | <i>Y. Johmura</i> | <i>G. Matsumoto</i> | <i>J. Sakaguchi</i> | <i>H. Iida</i> |
| Rev.No. | Date | Page | Descriptions | | | |
| 01 | May 27, 2009 | 1 | 3. Mechanical specifications ~Delete () | | | |
| | | 4 | 6. Optical characteristics ~Change "Chromaticity coordinates" ~Delete () | | | |
| | | 10 | 9. Backlight characteristics ~Change regulations of life time. | | | |
| | | | | | | |

1. Application

This document defines the specification of TCG057QVLCA-G00. (RoHS Compliant)

2. Construction and outline

LCD : Transmissive color dot matrix type TFT
 Backlight system : LED
 Polarizer : Glare treatment
 Additional circuit : Timing controller, Power supply (3.3V input)
 (without constant current circuit for LED Backlight)

3. Mechanical specifications

| Item | Specification | Unit |
|-----------------------|---|------|
| Outline dimensions 1) | 144(W)×(104.8)(H)×13(D) | mm |
| Active area | 115.2(W)×86.4(H) (14.4cm/5.7 inch(Diagonal)) | mm |
| Dot format | 320×(B,G,R)(W)×240(H) | dot |
| Dot pitch | 0.12(W)×0.36(H) | mm |
| Base color 2) | Normally White | - |
| Mass | 210 | g |

1) Projection not included. Please refer to outline for details.

2) Due to the characteristics of the LCD material, the color varies with environmental temperature.

4. Absolute maximum ratings

4-1. Electrical absolute maximum ratings

| Item | Symbol | Min. | Max. | Unit |
|-------------------------|-----------------|------|------|------|
| Supply voltage | V _{DD} | 0 | 4.0 | V |
| Input signal voltage 1) | V _{IN} | -0.3 | 6.0 | V |
| LED forward current 2) | I _F | - | 27 | mA |
| Reversed voltage 2) | V _R | - | 5 | V |

- 1) Input signal : CK, R0~R5, G0~G5, B0~B5, H_{SYNC}, V_{SYNC}, ENAB, R/L, U/D
- 2) For each "AN-CA"

4-2. Environmental absolute maximum ratings

| Item | Symbol | Min. | Max. | Unit |
|--------------------------|------------------|------|------|------|
| Operating temperature 1) | T _{OP} | -20 | 70 | °C |
| Storage temperature 2) | T _{STO} | -30 | 80 | °C |
| Operating humidity 3) | H _{OP} | 10 | 4) | %RH |
| Storage humidity 3) | H _{STO} | 10 | 4) | %RH |
| Vibration | - | 5) | 5) | - |
| Shock | - | 6) | 6) | - |

- 1) Operating temperature means a temperature which operation shall be guaranteed. Since display performance is evaluated at 25°C, another temperature range should be confirmed.
- 2) Temp. = -30°C < 48h , Temp. = 80°C < 168h
Store LCD at normal temperature/humidity. Keep them free from vibration and shock.
An LCD that is kept at a low or a high temperature for a long time can be defective due to other conditions, even if the low or high temperature satisfies the standard.
(Please refer to "Precautions for Use" for details.)

- 3) Non-condensing
- 4) Temp. ≤ 40°C, 85%RH Max.
Temp. > 40°C, Absolute humidity shall be less than 85%RH at 40°C.
- 5)

| | | |
|-----------------|-------------|---|
| Frequency | 10~55 Hz | Acceleration value (0.3~9 m/s ²) |
| Vibration width | 0.15mm | |
| Interval | 10-55-10 Hz | 1 minutes |

2 hours in each direction X, Y, Z (6 hours total)

EIAJ ED-2531

- 6) Acceleration: 490 m/s², Pulse width: 11 ms
3 times in each direction: ±X, ±Y, ±Z
EIAJ ED-2531

5. Electrical characteristics

Temp. = -20~70°C

| Item | Symbol | Condition | Min. | Typ. | Max. | Unit |
|----------------------------------|----------|--------------|-------------|------|-------------|-------|
| Supply voltage 1) | V_{DD} | - | 3.0 | 3.3 | 3.6 | V |
| Current consumption | I_{DD} | 2) | - | 60 | 80 | mA |
| Permissible input ripple voltage | V_{RP} | - | - | - | 100 | mVp-p |
| Input signal voltage 3) | V_{IL} | "Low" level | 0 | - | $0.3V_{DD}$ | V |
| | V_{IH} | "High" level | $0.7V_{DD}$ | - | +5.5 | V |

1) V_{DD} -turn-on conditions

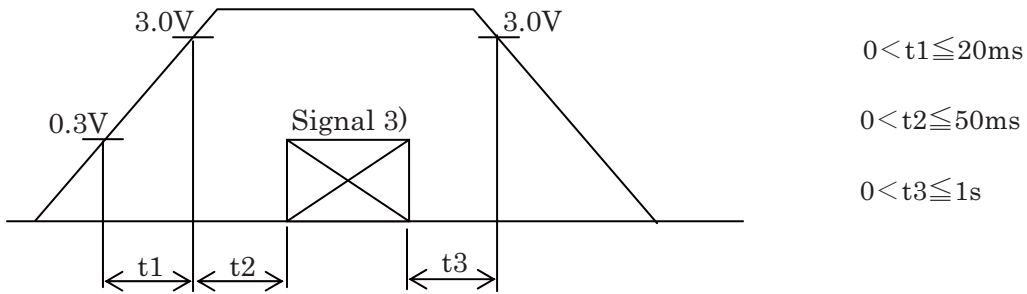

2) Display pattern:

$V_{DD} = 3.3V$, Temp. = 25°C

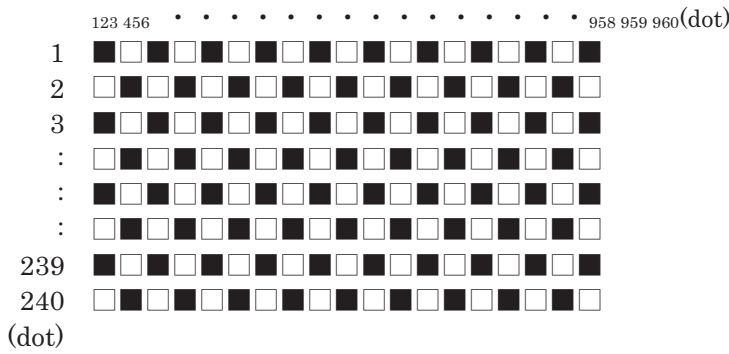

3) Input signal : CK, R0~R5, G0~G5, B0~B5, H_{SYNC}, V_{SYNC}, ENAB, R/L, U/D

6. Optical characteristics

Measuring spot = ϕ 6.0mm, Temp. = 25°C

| Item | Symbol | Condition | Min. | Typ. | Max. | Unit | |
|---|------------------|---------------------------|---------------------------|------|------|-------------------|----|
| Response time | Rise | τ_r | $\theta = \phi = 0^\circ$ | - | 10 | - | ms |
| | Down | τ_d | $\theta = \phi = 0^\circ$ | - | 25 | - | ms |
| Viewing angle range View direction : 12 o'clock (Gray inversion) | θ_{UPPER} | CR \geq 5 | - | 80 | - | deg. | |
| | θ_{LOWER} | | - | 80 | - | | |
| | ϕ_{LEFT} | | - | 80 | - | deg. | |
| | ϕ_{RIGHT} | | - | 80 | - | | |
| Contrast ratio | CR | $\theta = \phi = 0^\circ$ | 300 | 500 | - | - | |
| Brightness | L | IL=25mA/Line | 240 | 350 | - | cd/m ² | |
| Chromaticity coordinates | Red | x | $\theta = \phi = 0^\circ$ | 0.57 | 0.62 | 0.67 | - |
| | | y | | 0.31 | 0.36 | 0.41 | |
| | Green | x | $\theta = \phi = 0^\circ$ | 0.29 | 0.34 | 0.39 | |
| | | y | | 0.55 | 0.60 | 0.65 | |
| | Blue | x | $\theta = \phi = 0^\circ$ | 0.09 | 0.14 | 0.19 | |
| | | y | | 0.05 | 0.10 | 0.15 | |
| | White | x | $\theta = \phi = 0^\circ$ | 0.29 | 0.34 | 0.39 | |
| | | y | | 0.31 | 0.36 | 0.41 | |

6-1. Definition of contrast ratio

$$CR(\text{Contrast ratio}) = \frac{\text{Brightness with all pixels "White"}}{\text{Brightness with all pixels "Black"}}$$

6-2. Definition of response time

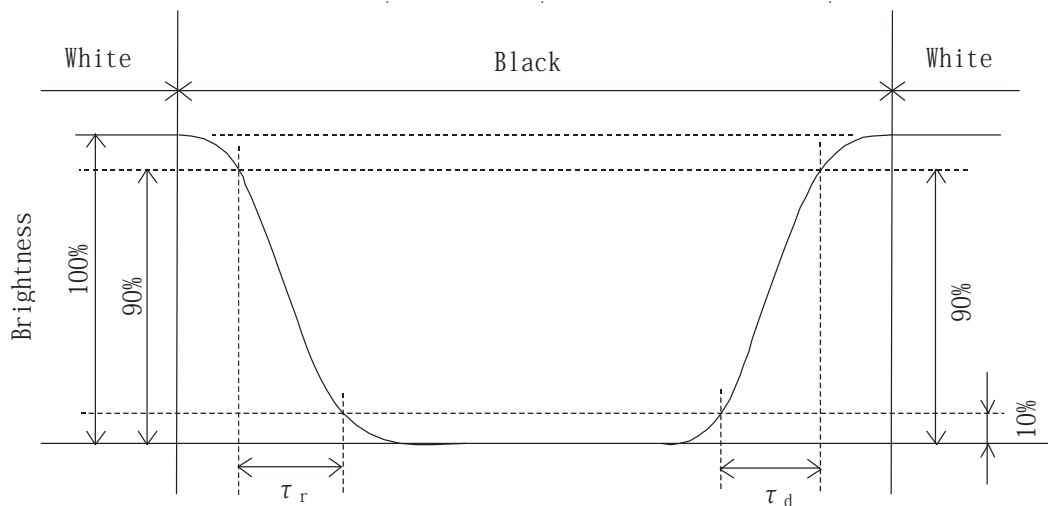

6-3. Definition of viewing angle

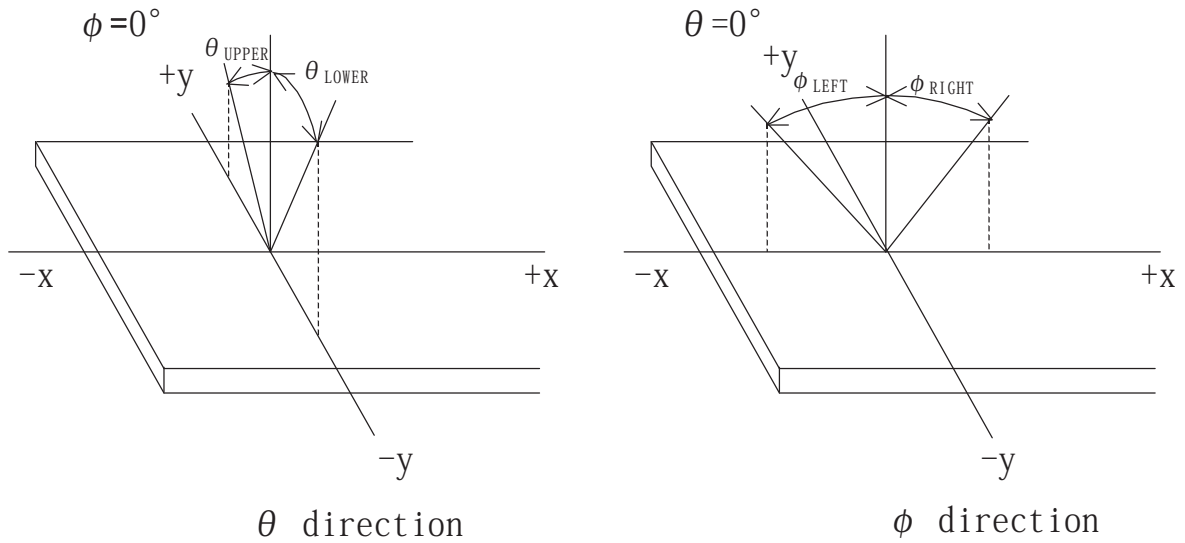

6-4. Brightness measuring points

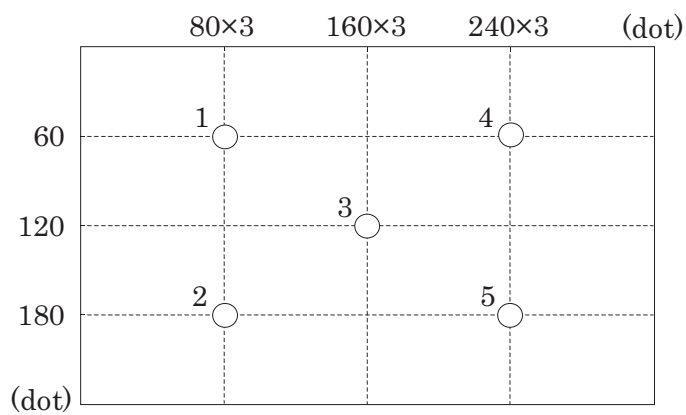

- 1) Rating is defined on the average in the viewing area. (measured point 1~5)
- 2) Measured 30 minutes after the CFL is powered on. (Ambient temp. = 25°C)

7. Interface signals

7-1. LCD

| No. | Symbol | Description | I/O | Note |
|-----|-------------------|---|-----|------|
| 1 | GND | GND | - | |
| 2 | CK | Clock signal for sampling each data signal | I | |
| 3 | H _{SYNC} | Horizontal synchronous signal (negative) | I | |
| 4 | V _{SYNC} | Vertical synchronous signal (negative) | I | |
| 5 | GND | GND | - | |
| 6 | R0 | RED data signal (LSB) | I | |
| 7 | R1 | RED data signal | I | |
| 8 | R2 | RED data signal | I | |
| 9 | R3 | RED data signal | I | |
| 10 | R4 | RED data signal | I | |
| 11 | R5 | RED data signal (MSB) | I | |
| 12 | GND | GND | - | |
| 13 | G0 | GREEN data signal (LSB) | I | |
| 14 | G1 | GREEN data signal | I | |
| 15 | G2 | GREEN data signal | I | |
| 16 | G3 | GREEN data signal | I | |
| 17 | G4 | GREEN data signal | I | |
| 18 | G5 | GREEN data signal (MSB) | I | |
| 19 | GND | GND | - | |
| 20 | B0 | BLUE data signal (LSB) | I | |
| 21 | B1 | BLUE data signal | I | |
| 22 | B2 | BLUE data signal | I | |
| 23 | B3 | BLUE data signal | I | |
| 24 | B4 | BLUE data signal | I | |
| 25 | B5 | BLUE data signal (MSB) | I | |
| 26 | GND | GND | - | |
| 27 | ENAB | Signal to settle the horizontal display position (positive) | I | 1) |
| 28 | V _{DD} | 3.3V power supply | - | |
| 29 | V _{DD} | 3.3V power supply | - | |
| 30 | R/L | Horizontal display mode select signal L : Normal , H : Left / Right reverse mode | I | 2) |
| 31 | U/D | Vertical display mode select signal H : Normal , L : Up / Down reverse mode | I | 2) |
| 32 | NC | No connect | I | |
| 33 | GND | GND | - | |

LCD connector : 08-6210-033-340-800+ (ELCO)
Recommended matching FFC or FPC : 0.5mm pitch

- 1) The horizontal display start timing is settled in accordance with a rising timing of ENAB signal.
In case ENAB is fixed "Low", the horizontal start timing is determined.
Don't keep ENAB "High" during operation.

2)



R/L = L
U/D = H



R/L = H
U/D = H



R/L = L
U/D = L

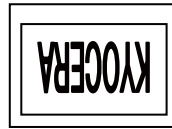

R/L = H
U/D = L

7-2. LED

| No. | Symbol | Description |
|-----|--------|-------------|
| 1 | AN1 | Anode 1 |
| 2 | AN2 | Anode 2 |
| 3 | AN3 | Anode 3 |
| 4 | CA1 | Cathode 1 |
| 5 | CA2 | Cathode 2 |
| 6 | CA3 | Cathode 3 |

LCD side connector : SHLP-06V-S-B (JST)

Recommended matching connector

: SM06B-SHLS-TF (JST)

: SM06B-SHLS-TF(LF)(SN) (JST)···(RoHS Compliant)

8. Input timing characteristics

8-1. Timing characteristics

| Item | | Symbol | Min | Typ | Max | Unit | Note |
|--------------------------------------|-------------|--------|------|------|--------|---------|------|
| Clock | Frequency | 1/Tc | — | 6.3 | 7.0 | MHz | |
| | Duty ratio | Tch/Tc | 40 | 50 | 60 | % | |
| Data | Set up time | Tds | 5 | — | — | ns | |
| | Hold time | Tdh | 10 | — | — | ns | |
| Horizontal sync. signal | Cycle | TH | 50.0 | 63.6 | — | μs | |
| | | | 360 | 400 | 450 | clock | |
| | Pulse width | THp | 2 | 96 | 200 | clock | |
| Vertical sync. signal | Cycle | TV | 251 | 262 | 280 | line | |
| | Pulse width | TVp | 2 | — | 34 | line | |
| Horizontal display period | | THd | 320 | | | clock | |
| Hsync, -Clock phase difference | | THc | 10 | — | Tc-10 | ns | |
| Hsync-Vsync. phase difference | | TVh | Tc | — | TH-THp | ns | |
| Vertical sync. signal start position | | TVs | 7 | | | line | |
| Vertical display period | | TVd | 240 | | | line | |

- 1) In case of lower frequency, the deterioration of the display quality, flicker etc., may occur.

8-2. Horizontal display position

| Item | | Symbol | Min | Typ | Max | Unit | Note |
|--|-------------|--------|-----|-----|--------|-------|------|
| Enable signal | Set up time | Tes | 5 | — | Tc-10 | ns | |
| | Pulse width | Tep | 2 | 320 | TH-10 | clock | |
| H _{SYNC} – Enable signal phase difference | | The | 2 | — | TH-340 | clock | |

- 1) When ENAB is fixed at "Low", the display starts from the data of C52(clock) as shown in 8-5.
- 2) The horizontal display position is determined by ENAB signal.

8-3. Vertical display position

- 1) The vertical display position (TVs) is 7th line.
- 2) ENAB signal is independent of vertical display position.

8-4. Input Data Signals and Display position on the screen

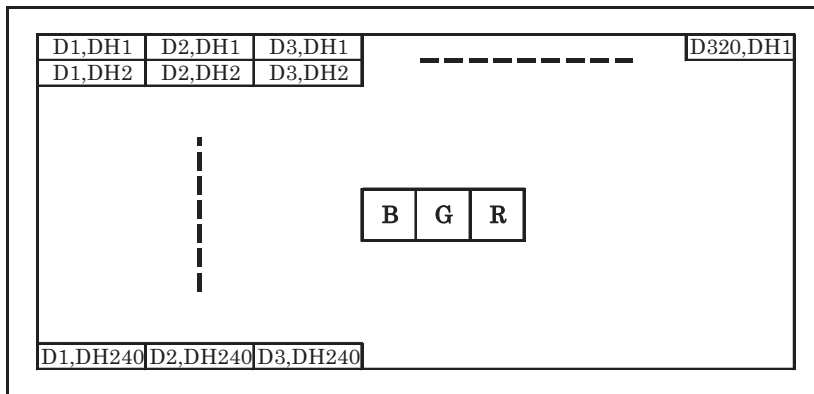

8-5. Input timing characteristics

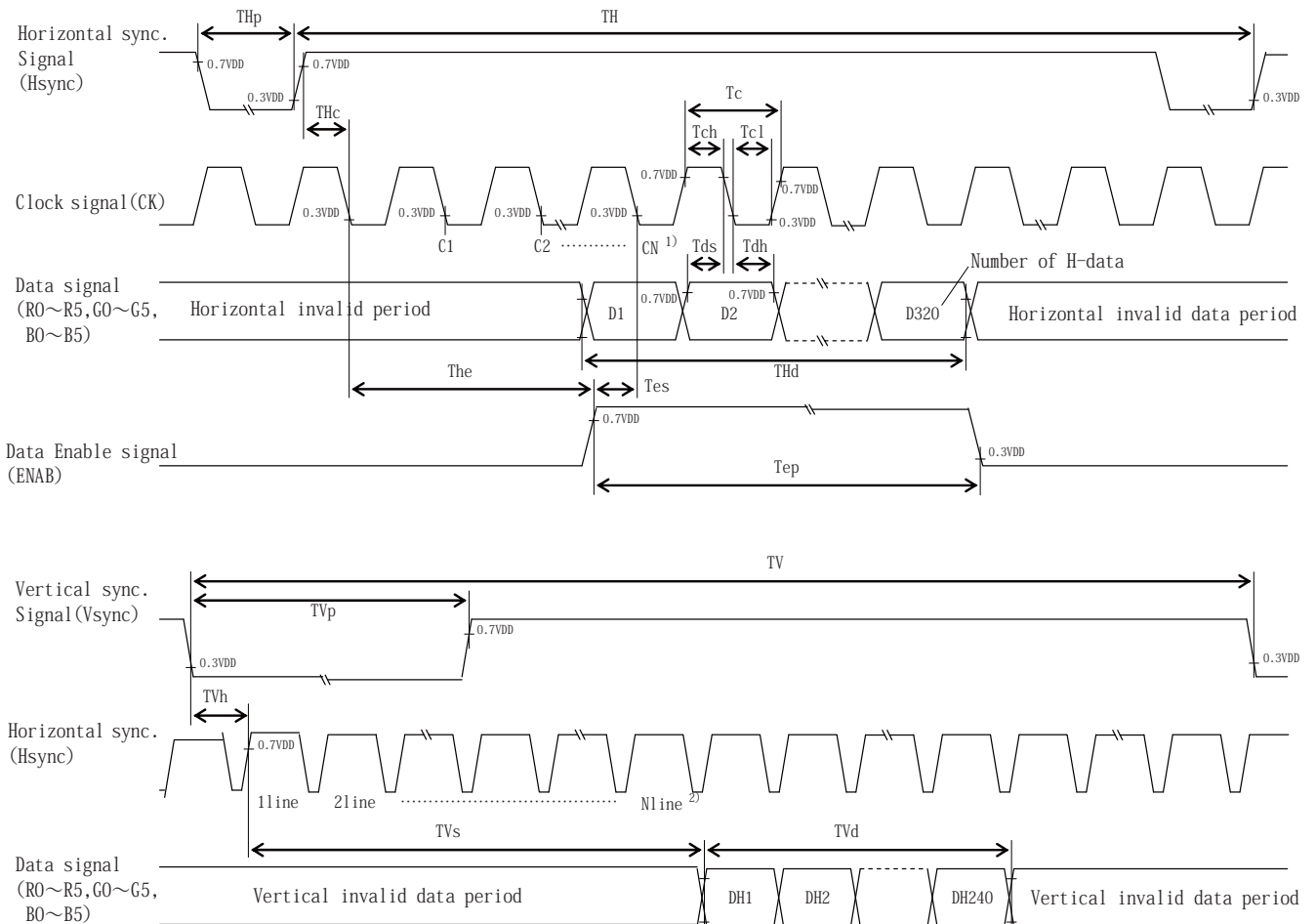

- 1) When ENAB is fixed at "Low", the display starts from the data of C52(Clock).
- 2) The vertical display position(TVs) is fixed at 7th line.

9. Backlight characteristics

Temp.=25°C

| Item | Symbol | Min. | Typ. | Max. | Unit | Note |
|----------------------------|--------|------|--------|------|------|-------------------|
| Forward current 1) | IF | - | 25 | - | mA | Ta=-20~70°C |
| Forward voltage 1) | VF | - | 24.5 | 27.3 | V | IF=25mA, Ta=-20°C |
| | | - | 23.1 | 25.9 | V | IF=25mA, Ta=25°C |
| | | - | 22.1 | 24.9 | V | IF=25mA, Ta=70°C |
| Operating life time 2), 3) | T | - | 50,000 | - | h | IF=25mA, Ta=25°C |

- 1) For each "AN-CA"
- 2) When brightness decrease 50% of minimum brightness.
- 3) Life time is estimated data.(Condition : IF=25mA, Ta=25°C in chamber).
- 4) An input current below 8.0mA may reduce the brightness uniformity of the LED backlight.
This is because the amount of light from each LED chip is different. Therefore, please evaluate carefully before finalizing the input current.

10. Lot number identification

The lot number shall be indicated on the back of the backlight case of each LCD.

TCG057QVLCA-G00 - □□ - □□ - □ MADE IN □□□□□
 ↓ ↓ ↓ ↓ ↓
 1 2 3 4 5

No1. - No5. above indicate
 1. Year code
 2. Month code
 3. Date
 4. Version Number
 5. Country of origin (Japan or China)

| | | | | | | |
|------|------|------|------|------|------|------|
| Year | 2009 | 2010 | 2011 | 2012 | 2013 | 2014 |
| Code | 9 | 0 | 1 | 2 | 3 | 4 |

| | | | | | | |
|-------|------|------|------|------|-----|------|
| Month | Jan. | Feb. | Mar. | Apr. | May | Jun. |
| Code | 1 | 2 | 3 | 4 | 5 | 6 |

| | | | | | | |
|-------|------|------|------|------|------|------|
| Month | Jul. | Aug. | Sep. | Oct. | Nov. | Dec. |
| Code | 7 | 8 | 9 | X | Y | Z |

11. Warranty

11-1. Incoming inspection

Please inspect the LCD within one month after your receipt.

11-2. Production warranty

Kyocera warrants its LCD's for a period of 12 months from the ship date. Kyocera shall, by mutual agreement, replace or re-work defective LCD's that are shown to be Kyocera's responsibility.

12. Precautions for use

12-1. Installation of the LCD

- 1) The LCD has a grounding hole. Please ground the LCD to prevent noise and to stabilize its performance as circumstances demand.

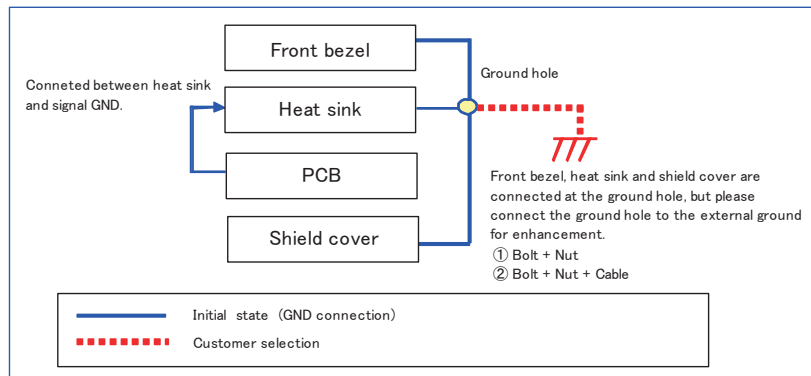

- 2) A transparent protection plate shall be added to protect the LCD and its polarizer
- 3) The LCD shall be installed so that there is no pressure on the LSI chips.
- 4) The LCD shall be installed flat, without twisting or bending.
- 5) Please refer to the following our recommendable value of Clamp-down torque when installing.
Clamp-down torque : $0.32 \pm 0.03 \text{N} \cdot \text{m}$
Please set up 'SPEED-LOW', 'SOFT START-SLOW' when using electric driver.
Recommendable screw JIS tapping screw two types nominal dia.3.0mm installing boss hole depth $3.5 \pm 0.5 \text{mm}$
Please be careful not to use high torque which may damage LCD in installation.
- 6) A transparent protection sheet is attached to the polarizer. Please remove the protection film slowly before use, paying attention to static electricity.

12-2. Static electricity

- 1) Since CMOS ICs are mounted directly onto the LCD glass, protection from static electricity is required.
- 2) Workers should use body grounding. Operator should wear ground straps.

12-3. LCD operation

- 1) The LCD shall be operated within the limits specified. Operation at values outside of these limits may shorten life, and/or harm display images.

12-4. Storage

- 1) The LCD shall be stored within the temperature and humidity limits specified.
Store in a dark area, and protect the LCD from direct sunlight or fluorescent light.
- 2) Always store the LCD so that it is free from external pressure onto it.

12-5. Usage

- 1) **DO NOT** store in a high humidity environment for extended periods. Polarizer degradation bubbles, and/or peeling off of the polarizer may result.
- 2) The front polarizer is easily scratched or damaged. Prevent touching it with any hard material, and from being pushed or rubbed.
- 3) The LCD screen may be cleaned by wiping the screen surface with a soft cloth or cotton pad using a little Ethanol.
- 4) Water may cause damage or discoloration of the polarizer. Clean condensation or moisture from any source immediately.
- 5) Always keep the LCD free from condensation during testing. Condensation may permanently spot or stain the polarizer.
- 6) Do not pull the LED lead wires and do not bend the root of the wires. Housing should be designed to protect LED lead wires from external stress.
- 7) Do not disassemble LCD because it will result in damage.
- 8) This Kyocera LCD has been specifically designed for use in general electronic devices, but not for use in a special environment such as usage in an active gas. Hence, when the LCD is supposed to be used in a special environment, evaluate the LCD thoroughly beforehand and do not expose the LCD to chemicals such as an active gas.
- 9) Please do not use solid-base image pattern for long hours because a temporary afterimage may appear. We recommend using screen saver etc. in cases where a solid-base image pattern must be used.
- 10) Liquid crystal may leak when the LCD is broken. Be careful not to let the fluid go into your eyes and mouth. In the case the fluid touches your body; rinse it off right away with water and soap.

13. Reliability test data

| Test item | Test condition | Test time | Judgement |
|--------------------------------|--------------------------------------|-----------|--|
| High temp. atmosphere | 80°C | 240h | Display function : No defect Display quality : No defect Current consumption : No defect |
| Low temp. atmosphere | -30°C | 240h | Display function : No defect Display quality : No defect Current consumption : No defect |
| High temp. humidity atmosphere | 40°C 90% RH | 240h | Display function : No defect Display quality : No defect Current consumption : No defect |
| Temp. cycle | -30°C 0.5h R.T. 0.5h 80°C 0.5h | 10cycles | Display function : No defect Display quality : No defect Current consumption : No defect |
| High temp. operation | 70°C | 500h | Display function : No defect Display quality : No defect Current consumption : No defect |

- 1) Each test item uses a test LCD only once. The tested LCD is not used in any other tests.
- 2) The LCD is tested in circumstances in which there is no condensation.
- 3) The reliability test is not an out-going inspection.
- 4) The result of the reliability test is for your reference purpose only.
The reliability test is conducted only to examine the LCD's capability.

| | |
|----------|-----------------------|
| Spec No. | TQ3C-8EAF0-E2DEG38-00 |
| Date | February 19, 2009 |

KYOCERA INSPECTION STANDARD

TYPE : TCG057QVLCA-G00

KYOCERA CORPORATION
KAGOSHIMA HAYATO PLANT
LCD DIVISION

| Original Issue Date | Designed by : Engineering dept. | | | Confirmed by : QA dept. | |
|---------------------|---------------------------------|-----------------|---------------------|-------------------------|---------------|
| | Prepared | Checked | Approved | Checked | Approved |
| February 19, 2009 | <i>Y. Asano</i> | <i>Y. Johno</i> | <i>Y. Matsumoto</i> | <i>J. Sakaguchi</i> | <i>T. Ito</i> |

Spec No.
TQ3C-8EAF0-E2DEG38-00

Part No.
TCG057QVLCA-G00

Page
-

Revision record

| Date | | Designed by : Engineering dept. | | | Confirmed by : QA dept. | |
|---------|------|---------------------------------|--------------|----------|-------------------------|----------|
| | | Prepared | Checked | Approved | Checked | Approved |
| | | | | | | |
| Rev.No. | Date | Page | Descriptions | | | |
| | | | | | | |

Visuals specification

1) Note

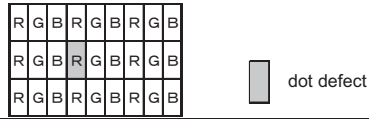
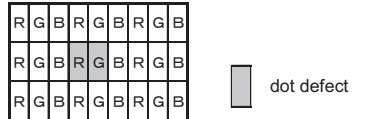
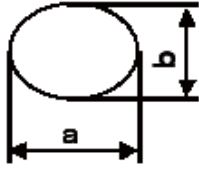
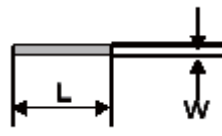
| | | Note |
|-------------------------------|---|---|
| General | | <p>1. Customer identified anomalies not defined within this inspection standard shall be reviewed by Kyocera, and an additional standard shall be determined by mutual consent.</p> <p>2. This inspection standard about the image quality shall be applied to any defect within the active area and shall not be applicable to outside of the area.</p> <p>3. Inspection conditions</p> <p>Luminance : 500 Lux min.</p> <p>Inspection distance : 300 mm.</p> <p>Temperature : 25 ± 5°C</p> <p>Direction : Directly above</p> |
| Definition of inspection item | Dot defect | <p>Bright dot defect</p> <p>The dot is constantly “on” when power applied to the LCD, even when all “Black” data sent to the screen. Inspection tool: 5% Transparency neutral density filter. Count dot: If the dot is visible through the filter. Don't count dot: If the dot is not visible through the filter.</p>  |
| | | <p>Black dot defect</p> <p>The dot is constantly “off” when power applied to the LCD, even when all “White” data sent to the screen.</p> |
| | | <p>Adjacent dot</p> <p>Adjacent dot defect is defined as two or more bright dot defects or black dot defects.</p>  |
| | External inspection | <p>Bubble, Scratch, Foreign particle (Polarizer, Cell, Backlight)</p> <p>Visible operating (all pixels “Black” or “White”) and non operating.</p> |
| | | <p>Appearance inspection</p> <p>Does not satisfy the value at the spec.</p> |
| | Others | <p>LED wires</p> <p>Damaged to the LED wires, connector, pin, functional failure or appearance failure.</p> |
| Definition of size | <p>Definition of circle size</p>  <p>$d = (a + b) / 2$</p> <p>Definition of linear size</p>  | |

2) Standard

| Classification | | Inspection item | Judgement standard | | | | | | | | | | | | | | | | |
|--|--|--|--|-----------------------|-------------------|-------------------|-------------------|--------------------|--------------------|---------------------|--------------------|--------------------|--------------------|-----------|-----------|-----------|-----------|---|-------------------------------|
| Defect (in LCD glass) | Dot defect | Bright dot defect | Acceptable number : 4 Bright dot spacing : 5 mm or more | | | | | | | | | | | | | | | | |
| | | Black dot defect | Acceptable number : 5 Black dot spacing : 5 mm or more | | | | | | | | | | | | | | | | |
| | | 2 dot join | Bright dot defect | Acceptable number : 2 | | | | | | | | | | | | | | | |
| | | | Black dot defect | Acceptable number : 3 | | | | | | | | | | | | | | | |
| | | 3 or more dots join | Acceptable number : 0 | | | | | | | | | | | | | | | | |
| | | Total dot defects | Acceptable number : 5 Max | | | | | | | | | | | | | | | | |
| | Others | White dot, Dark dot (Circle) | <table border="1"> <thead> <tr> <th>Size (mm)</th> <th>Acceptable number</th> </tr> </thead> <tbody> <tr> <td>$d \leq 0.2$</td> <td>(Neglected)</td> </tr> <tr> <td>$0.2 < d \leq 0.4$</td> <td>5</td> </tr> <tr> <td>$0.4 < d \leq 0.5$</td> <td>3</td> </tr> <tr> <td>$0.5 < d$</td> <td>0</td> </tr> </tbody> </table> | | | Size (mm) | Acceptable number | $d \leq 0.2$ | (Neglected) | $0.2 < d \leq 0.4$ | 5 | $0.4 < d \leq 0.5$ | 3 | $0.5 < d$ | 0 | | | | |
| Size (mm) | Acceptable number | | | | | | | | | | | | | | | | | | |
| $d \leq 0.2$ | (Neglected) | | | | | | | | | | | | | | | | | | |
| $0.2 < d \leq 0.4$ | 5 | | | | | | | | | | | | | | | | | | |
| $0.4 < d \leq 0.5$ | 3 | | | | | | | | | | | | | | | | | | |
| $0.5 < d$ | 0 | | | | | | | | | | | | | | | | | | |
| External inspection (Defect on Polarizer or between Polarizer and LCD glass) | Polarizer (Scratch) | <table border="1"> <thead> <tr> <th>Width (mm)</th> <th>Length (mm)</th> <th>Acceptable number</th> </tr> </thead> <tbody> <tr> <td>$W \leq 0.1$</td> <td>—</td> <td>(Neglected)</td> </tr> <tr> <td rowspan="2">$0.1 < W \leq 0.3$</td> <td>$L \leq 5.0$</td> <td>(Neglected)</td> </tr> <tr> <td>$5.0 < L$</td> <td>0</td> </tr> <tr> <td>$0.3 < W$</td> <td>—</td> <td>0</td> </tr> </tbody> </table> | | | Width (mm) | Length (mm) | Acceptable number | $W \leq 0.1$ | — | (Neglected) | $0.1 < W \leq 0.3$ | $L \leq 5.0$ | (Neglected) | $5.0 < L$ | 0 | $0.3 < W$ | — | 0 | |
| | | Width (mm) | Length (mm) | Acceptable number | | | | | | | | | | | | | | | |
| | | $W \leq 0.1$ | — | (Neglected) | | | | | | | | | | | | | | | |
| | | $0.1 < W \leq 0.3$ | $L \leq 5.0$ | (Neglected) | | | | | | | | | | | | | | | |
| | $5.0 < L$ | | 0 | | | | | | | | | | | | | | | | |
| | $0.3 < W$ | — | 0 | | | | | | | | | | | | | | | | |
| | Polarizer (Bubble) | <table border="1"> <thead> <tr> <th>Size (mm)</th> <th>Acceptable number</th> </tr> </thead> <tbody> <tr> <td>$d \leq 0.2$</td> <td>(Neglected)</td> </tr> <tr> <td>$0.2 < d \leq 0.3$</td> <td>5</td> </tr> <tr> <td>$0.3 < d \leq 0.5$</td> <td>3</td> </tr> <tr> <td>$0.5 < d$</td> <td>0</td> </tr> </tbody> </table> | | | Size (mm) | Acceptable number | $d \leq 0.2$ | (Neglected) | $0.2 < d \leq 0.3$ | 5 | $0.3 < d \leq 0.5$ | 3 | $0.5 < d$ | 0 | | | | | |
| | | Size (mm) | Acceptable number | | | | | | | | | | | | | | | | |
| | | $d \leq 0.2$ | (Neglected) | | | | | | | | | | | | | | | | |
| | | $0.2 < d \leq 0.3$ | 5 | | | | | | | | | | | | | | | | |
| $0.3 < d \leq 0.5$ | 3 | | | | | | | | | | | | | | | | | | |
| $0.5 < d$ | 0 | | | | | | | | | | | | | | | | | | |
| Foreign particle (Circular shape) | <table border="1"> <thead> <tr> <th>Size (mm)</th> <th>Acceptable number</th> </tr> </thead> <tbody> <tr> <td>$d \leq 0.2$</td> <td>(Neglected)</td> </tr> <tr> <td>$0.2 < d \leq 0.4$</td> <td>5</td> </tr> <tr> <td>$0.4 < d \leq 0.5$</td> <td>3</td> </tr> <tr> <td>$0.5 < d$</td> <td>0</td> </tr> </tbody> </table> | | | Size (mm) | Acceptable number | $d \leq 0.2$ | (Neglected) | $0.2 < d \leq 0.4$ | 5 | $0.4 < d \leq 0.5$ | 3 | $0.5 < d$ | 0 | | | | | | |
| | Size (mm) | Acceptable number | | | | | | | | | | | | | | | | | |
| | $d \leq 0.2$ | (Neglected) | | | | | | | | | | | | | | | | | |
| | $0.2 < d \leq 0.4$ | 5 | | | | | | | | | | | | | | | | | |
| $0.4 < d \leq 0.5$ | 3 | | | | | | | | | | | | | | | | | | |
| $0.5 < d$ | 0 | | | | | | | | | | | | | | | | | | |
| Foreign particle (Linear shape) Scratch | <table border="1"> <thead> <tr> <th>Width (mm)</th> <th>Length (mm)</th> <th>Acceptable number</th> </tr> </thead> <tbody> <tr> <td>$W \leq 0.03$</td> <td>—</td> <td>(Neglected)</td> </tr> <tr> <td rowspan="3">$0.03 < W \leq 0.1$</td> <td>$L \leq 2.0$</td> <td>(Neglected)</td> </tr> <tr> <td>$2.0 < L \leq 4.0$</td> <td>3</td> </tr> <tr> <td>$4.0 < L$</td> <td>0</td> </tr> <tr> <td>$0.1 < W$</td> <td>—</td> <td>(According to circular shape)</td> </tr> </tbody> </table> | | | Width (mm) | Length (mm) | Acceptable number | $W \leq 0.03$ | — | (Neglected) | $0.03 < W \leq 0.1$ | $L \leq 2.0$ | (Neglected) | $2.0 < L \leq 4.0$ | 3 | $4.0 < L$ | 0 | $0.1 < W$ | — | (According to circular shape) |
| | Width (mm) | Length (mm) | Acceptable number | | | | | | | | | | | | | | | | |
| | $W \leq 0.03$ | — | (Neglected) | | | | | | | | | | | | | | | | |
| | $0.03 < W \leq 0.1$ | $L \leq 2.0$ | (Neglected) | | | | | | | | | | | | | | | | |
| | | $2.0 < L \leq 4.0$ | 3 | | | | | | | | | | | | | | | | |
| $4.0 < L$ | | 0 | | | | | | | | | | | | | | | | | |
| $0.1 < W$ | — | (According to circular shape) | | | | | | | | | | | | | | | | | |