

DETAILS

Product Number	CP12941_LARISA-M-CLIP16
Family	Larisa
Type	Assembly
Color	black
Diameter	9,9 + 9,9 mm
Height	7,5 mm
Style	square
Optic Material	PMMA
Holder Material	
Fastening	clips
Status	production ready
ROHS Compliant	Yes
Date Updated	3/02/2017



OPTICAL PROPERTIES

LED	Viewing	Light	Efficiency	cd/lm	Connector
	Angle	Beam			
XP-G	36 deg	Medium	88 %	1.900	-
XB-D	30 deg	Medium	84 %	2.300	-
XP-E	sim: 23	Medium	sim: 94 %	-	-
XQ-E	25 deg	Medium	86 %	3.000	-
XQ-E HI	19 deg	Medium	79 %	3.600	-
H35C0 (LEMWA33)	37 deg	Medium	87 %	1.840	-
H35B0 (LEMWA32)	31 deg	Medium	89 %	2.400	-
LUXEON Rebel	26 deg	Medium	88 %	3.000	-
LUXEON Rebel ES	35 deg	Medium	87 %	1.900	-
LUXEON A	37 deg	Medium	86 %	1.700	-
LUXEON Z	19 deg	Medium	84 %	5.000	-
LUXEON Z ES	24 deg	Medium	88 %	3.300	-
LUXEON C	27 deg	Medium	85 %	2.910	-
NCSxx19A	27 deg	Medium	84 %	2.500	-
NVSxx19A	34 deg	Medium	84 %	1.900	-
Oslon Square EC	31 deg	Medium	83 %	2.000	-
Oslon SSL 150	30 deg	Medium	88 %	2.600	-
Duris S5 (2 chip)	34 deg	Medium	80 %	1.900	-
Oslon SSL 80	25 deg	Medium	82 %	2.910	-

Relative intensity of CP12941_LARISA-M-CLIP16_(XQ-E_HI)

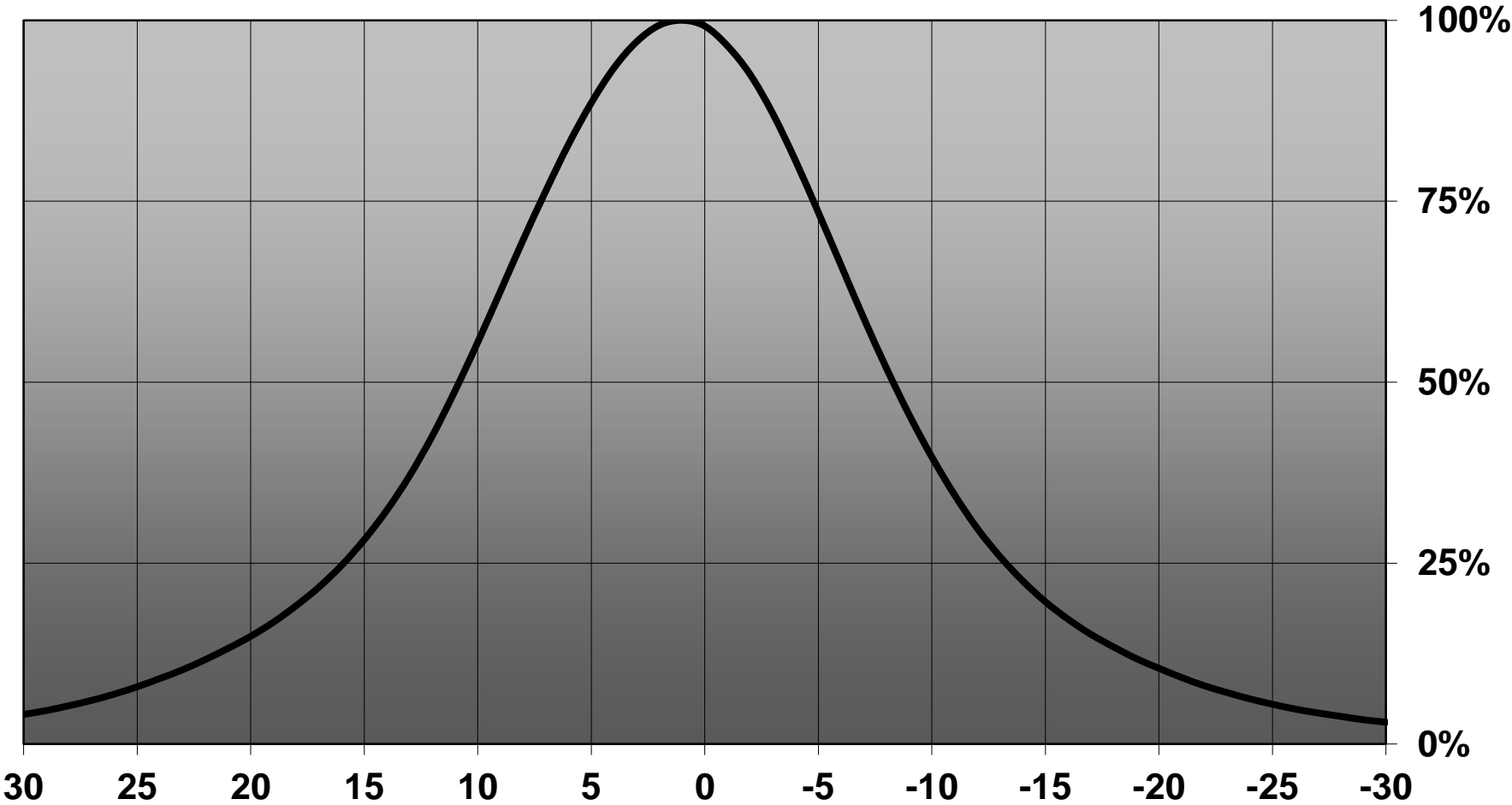

Relative intensity of CP12941_LARISA-M-CLIP16_(Luxeon Z)

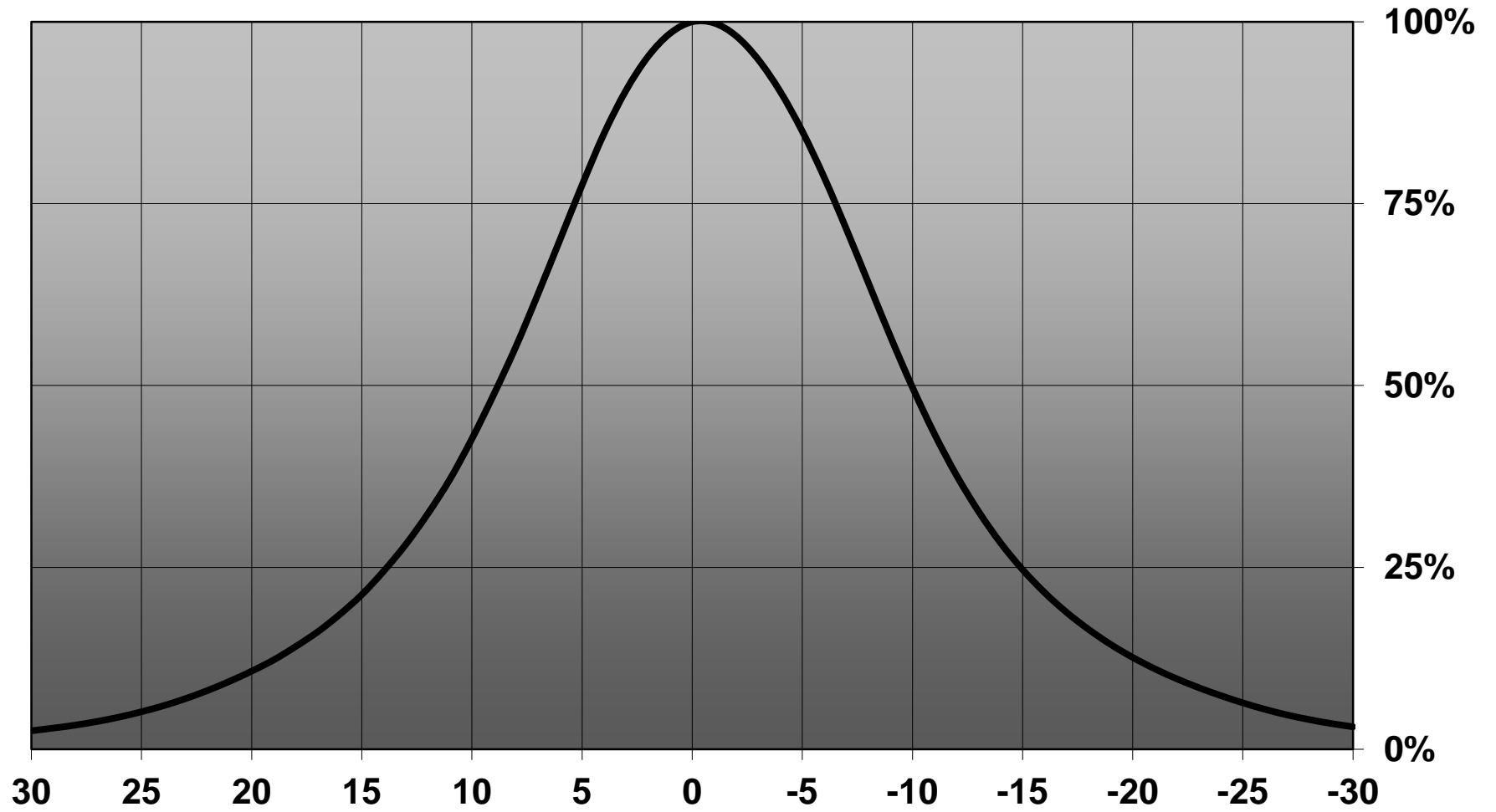

Relative intensity of CP12941_LARISA-M-CLIP16_(SSL80)

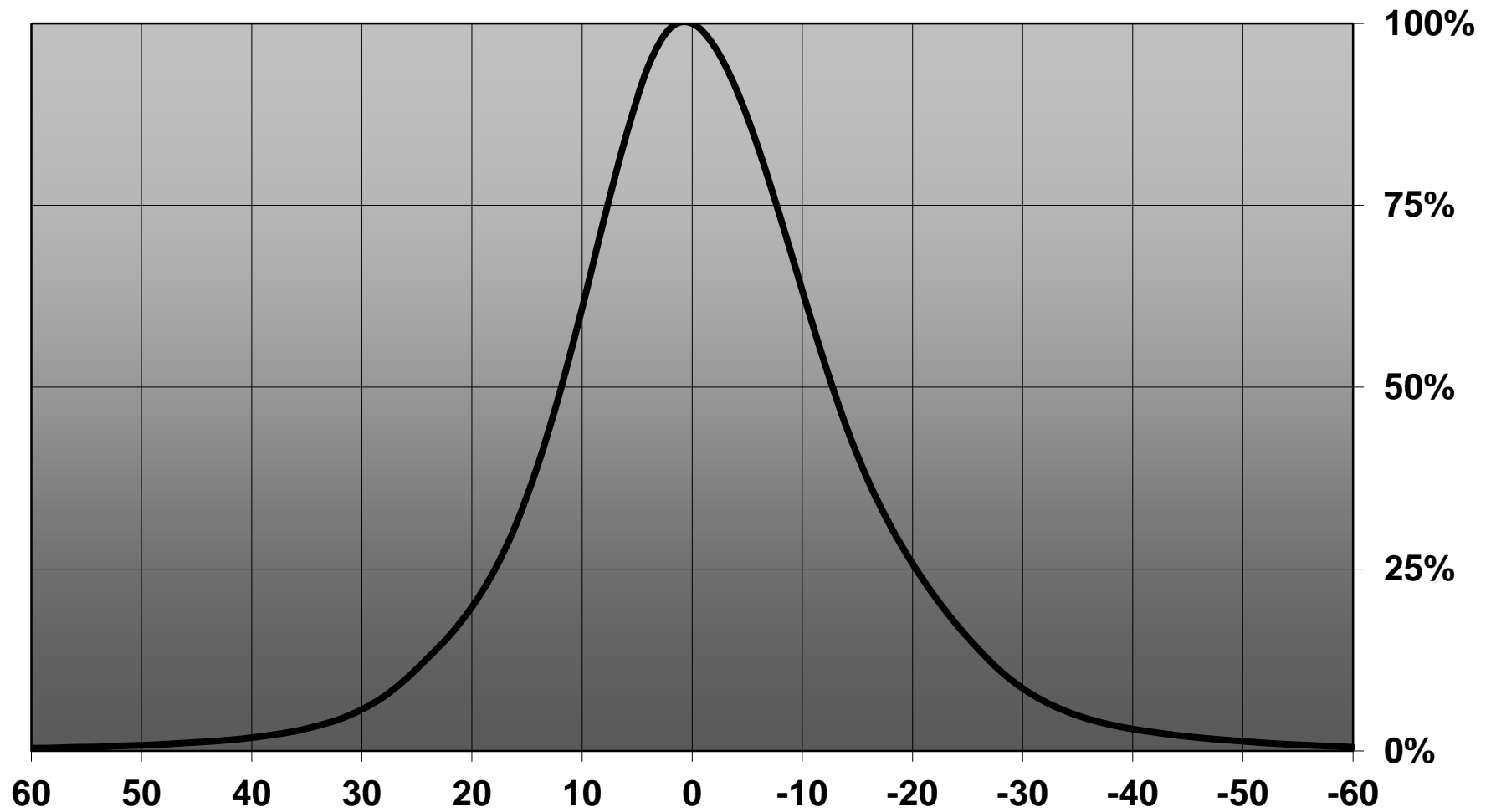

Designed for the following pin hole dimensions:
 Hole diameter 1.95mm
 Hole distance 8.6mm
 PCB thickness 1.6mm

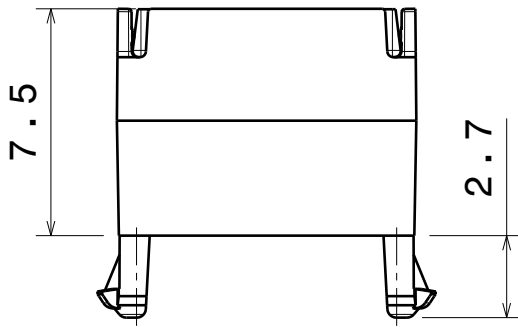

Front view

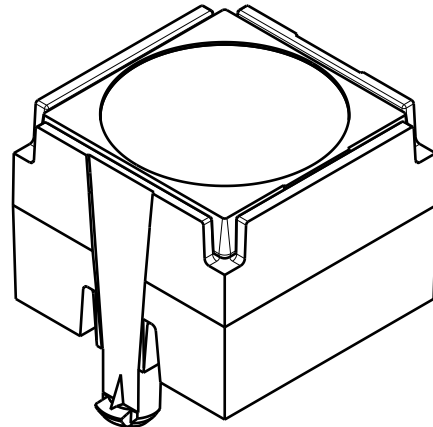

Isometric view
 Scale: 4:1

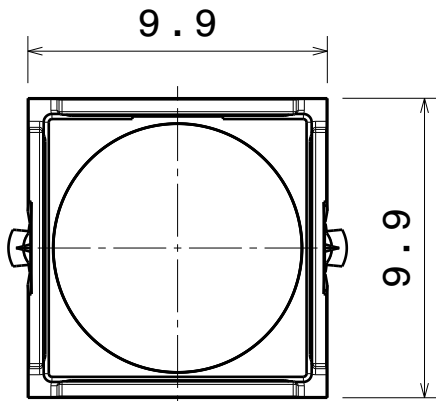

Top view

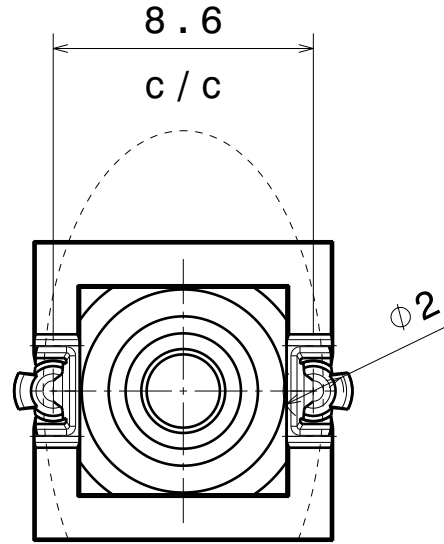

Bottom view

Oval beam direction

INDEX	PART NO	DESCRIPTION	MATERIAL	COLOUR
1	-	LARISA lens	PMMA	
2	C12908	LARISA-HOLDER-CLIP16	PC	black

Tolerances if not otherwise shown
 According to DIN ISO 2768-1
 Linear measures:
 Up to 30mm class M, otherwise class C.
 According to DIN ISO 2768-2
 Form and position: class L



Ledil Oy
 Salorankatu 10
 FIN 24240 SALO
 Finland

THIRD ANGLE PROJECTION:

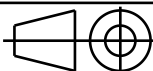

DRAWING TITLE

LARISA-CLIP16 series

This drawing is the property of LEDiL Oy. It may not be reproduced, copied or communicated without a written agreement with LEDiL Oy.

SIZE PART NUMBER

A4

-

SCALE 4:1 WEIGHT 0,6 g SHEET 1/1

Luminaire: LEDiL Oy LARISA-M_XP-G_(CLIP8&CLIP16) Eff.87.8%
Lamps: 1 x XP-G (62.2075lm@250mA)

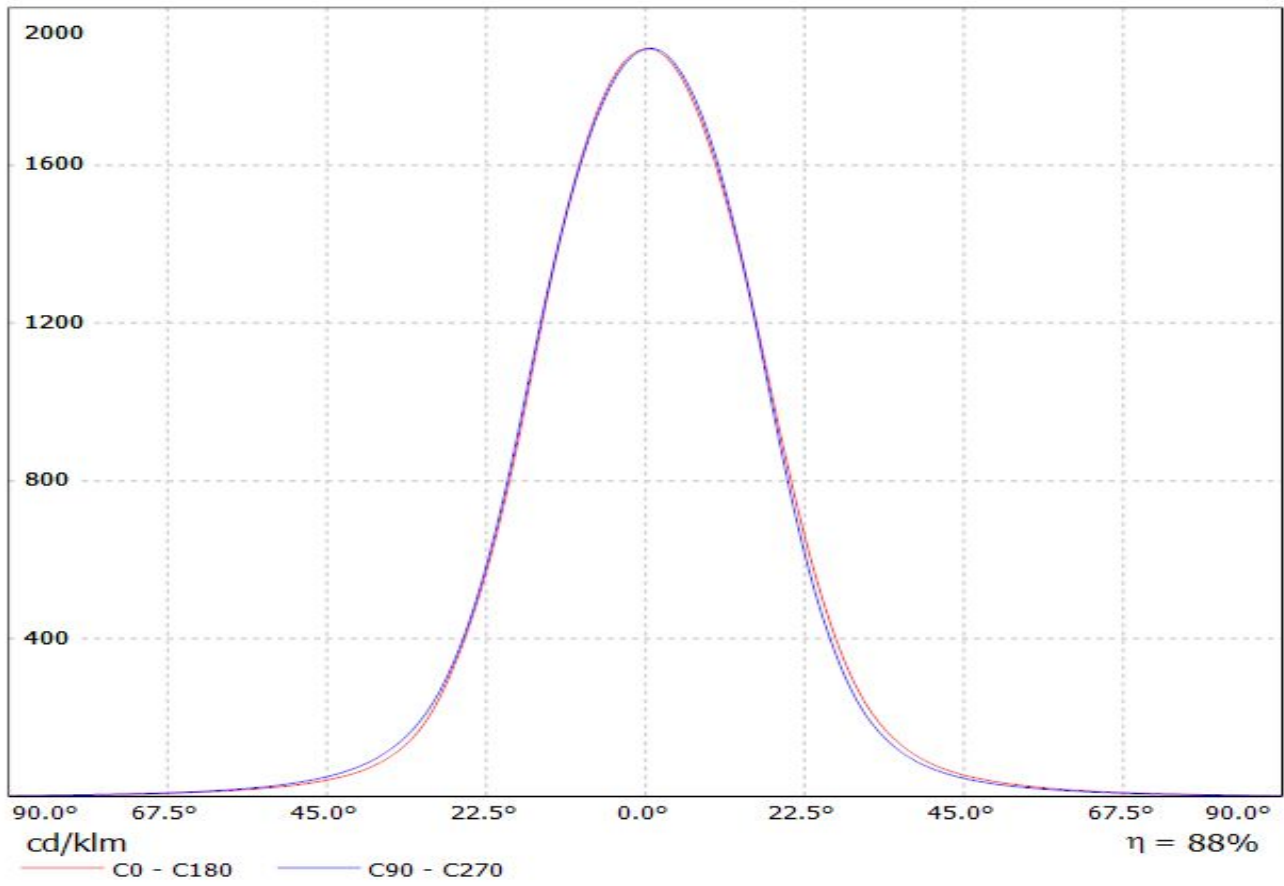

Valaisin: LEDiL Oy LARISA-M_XB-D_(CLIP8&CLIP16) Eff.84.0%
Lamput: 1 x XB-D (91.7428lm@250mA)

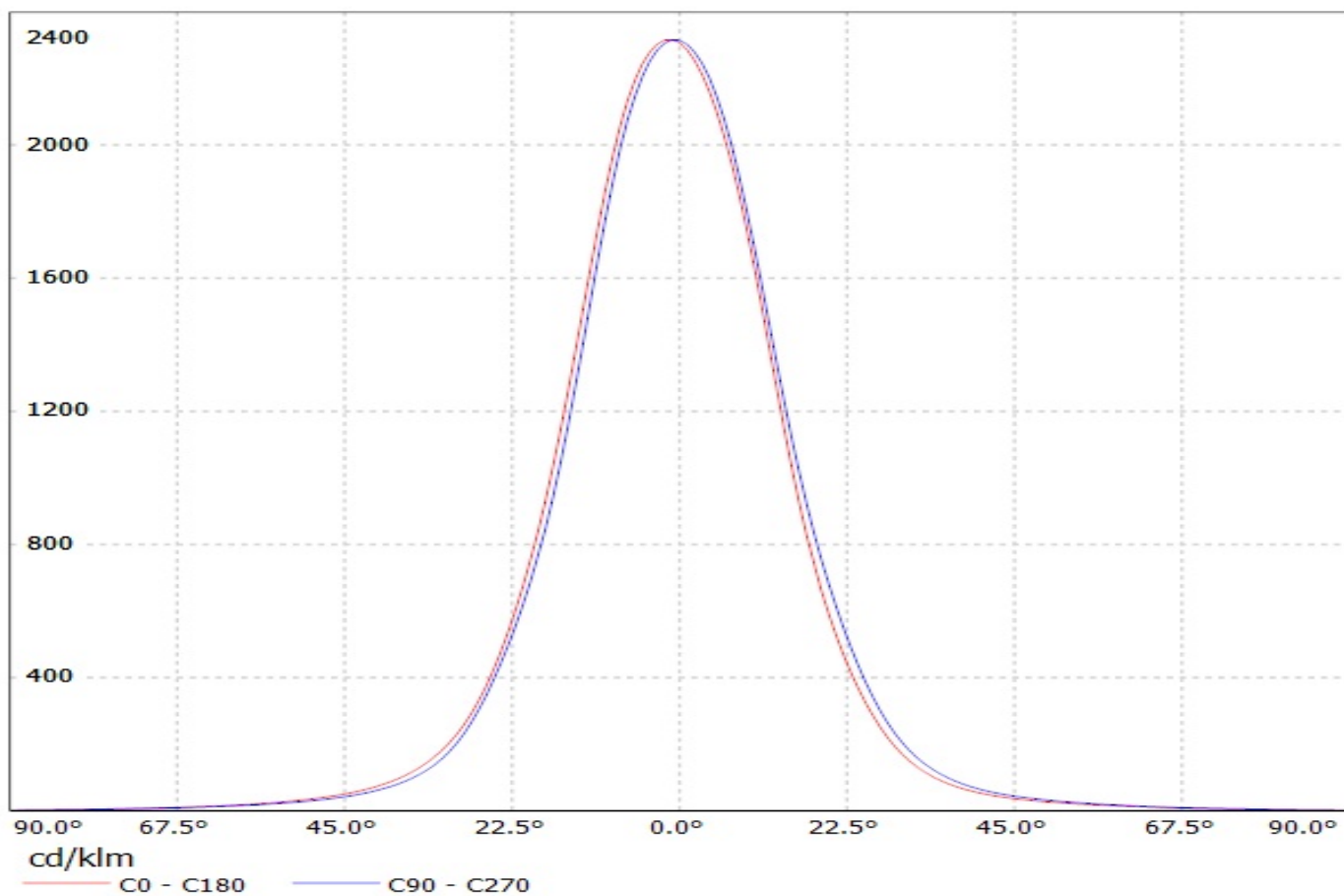

Luminaire: LEDiL Oy CP12941_LARISA-M-CLIP16_(XQ-E)

Lamps: 1 x Cree_XQ-E_(XQEAWT-0-7B1-Q40-0H-00001_81.2847lm@250mA_P=0.764419W_I=250mA

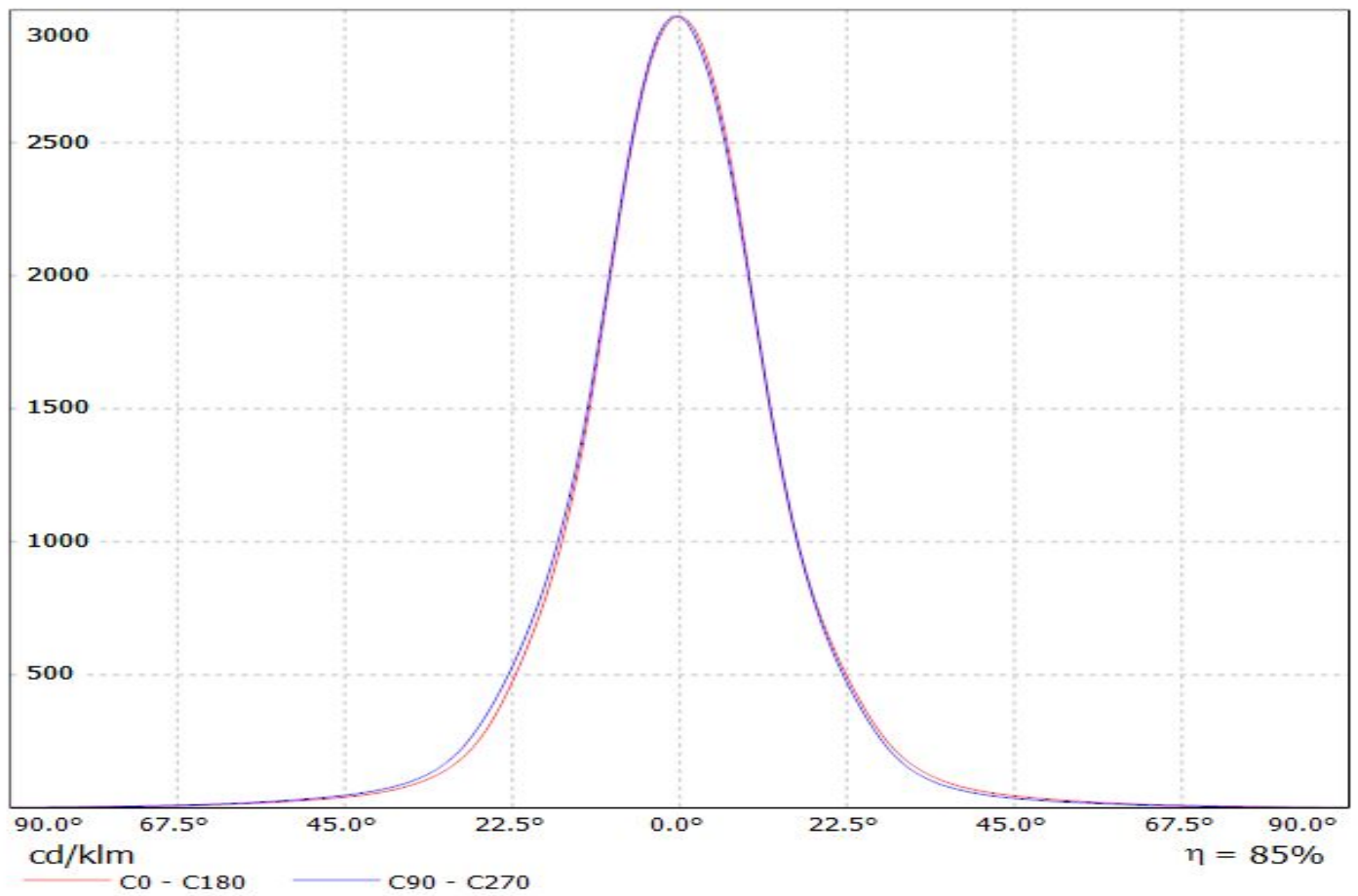

Luminaire: LEDiL Oy CP12941_LARISA-M-CLIP16_(3535_Ceramic) Eff.86.4%
Lamps: 1 x LG 3535 Ceramic (95lm@250mA)

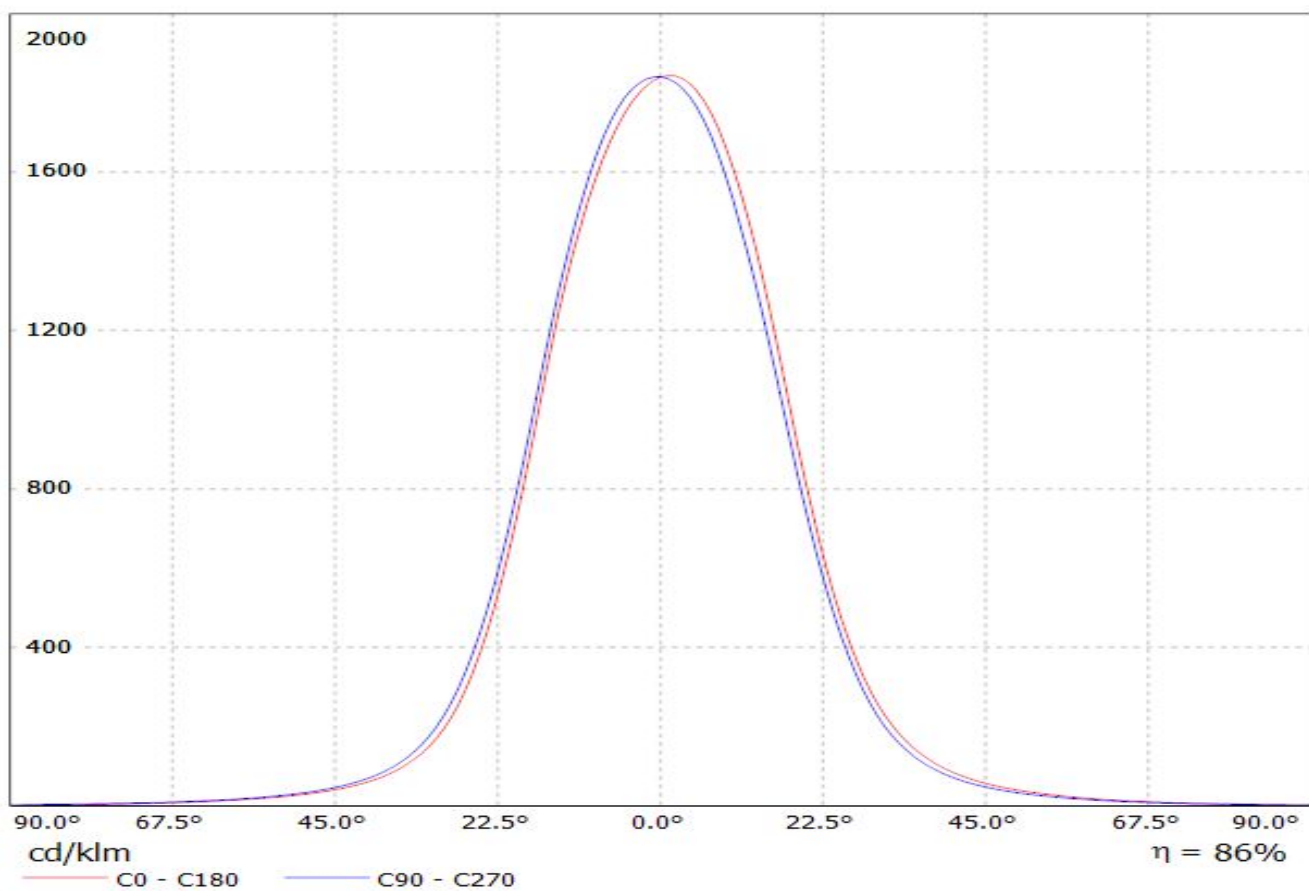

**LEDiL Oy CP12940_LARISA-M-CLIP8/CP12941_LARISA-M-CLIP16_
(LG3535_2W) Eff.89.1% / LDC (Linear)**

Luminaire: LEDiL Oy CP12940_LARISA-M-CLIP8/CP12941_LARISA-M-CLIP16_(LG3535_2W) Eff.89.1%
Lamps: 1 x LG3535_2W (97.3629lm@250mA)

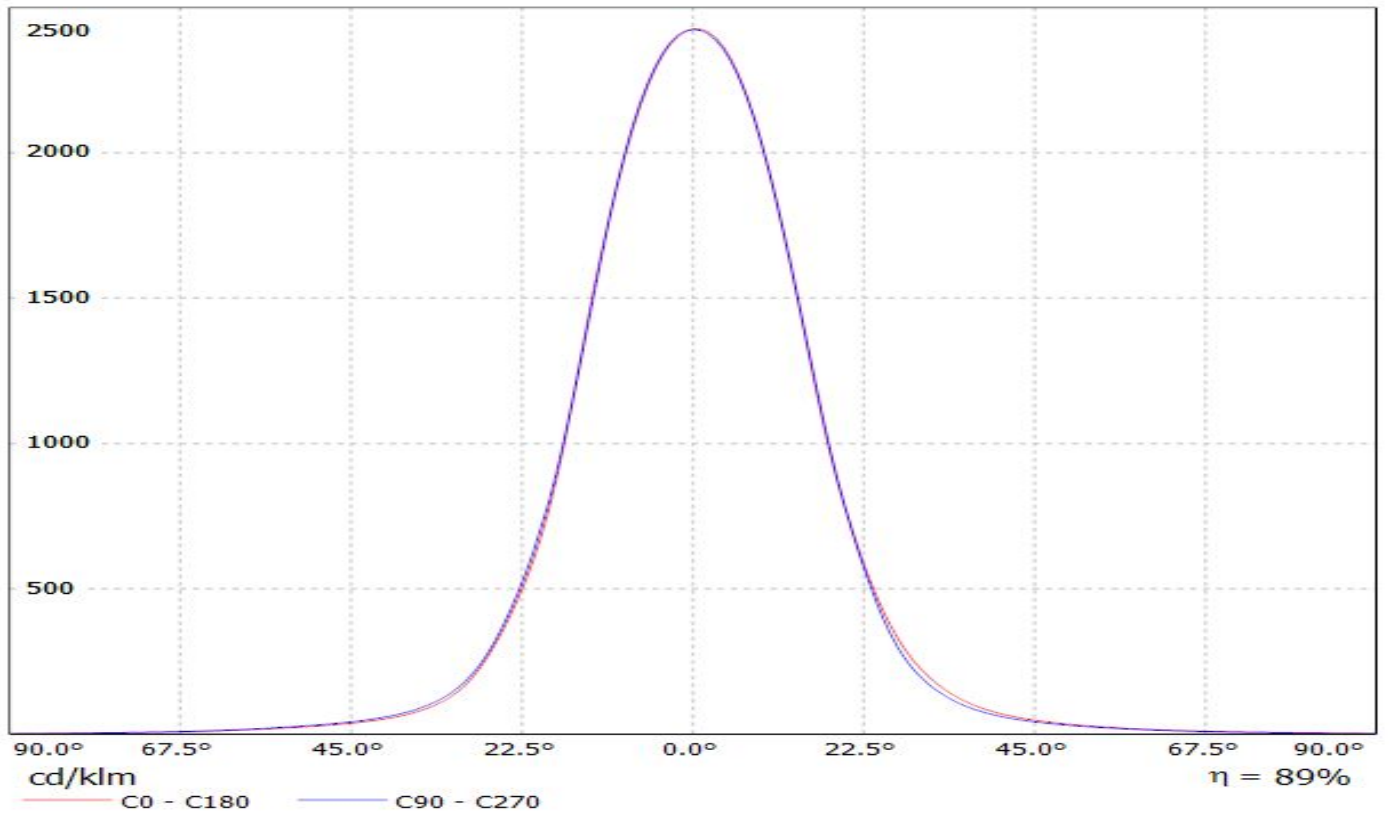

Luminaire: LEDiL Oy LARISA-M_Rebel_(CLIP8&CLIP16) Eff.88.0%
Lamps: 1 x Rebel (80.8775lm@250mA)

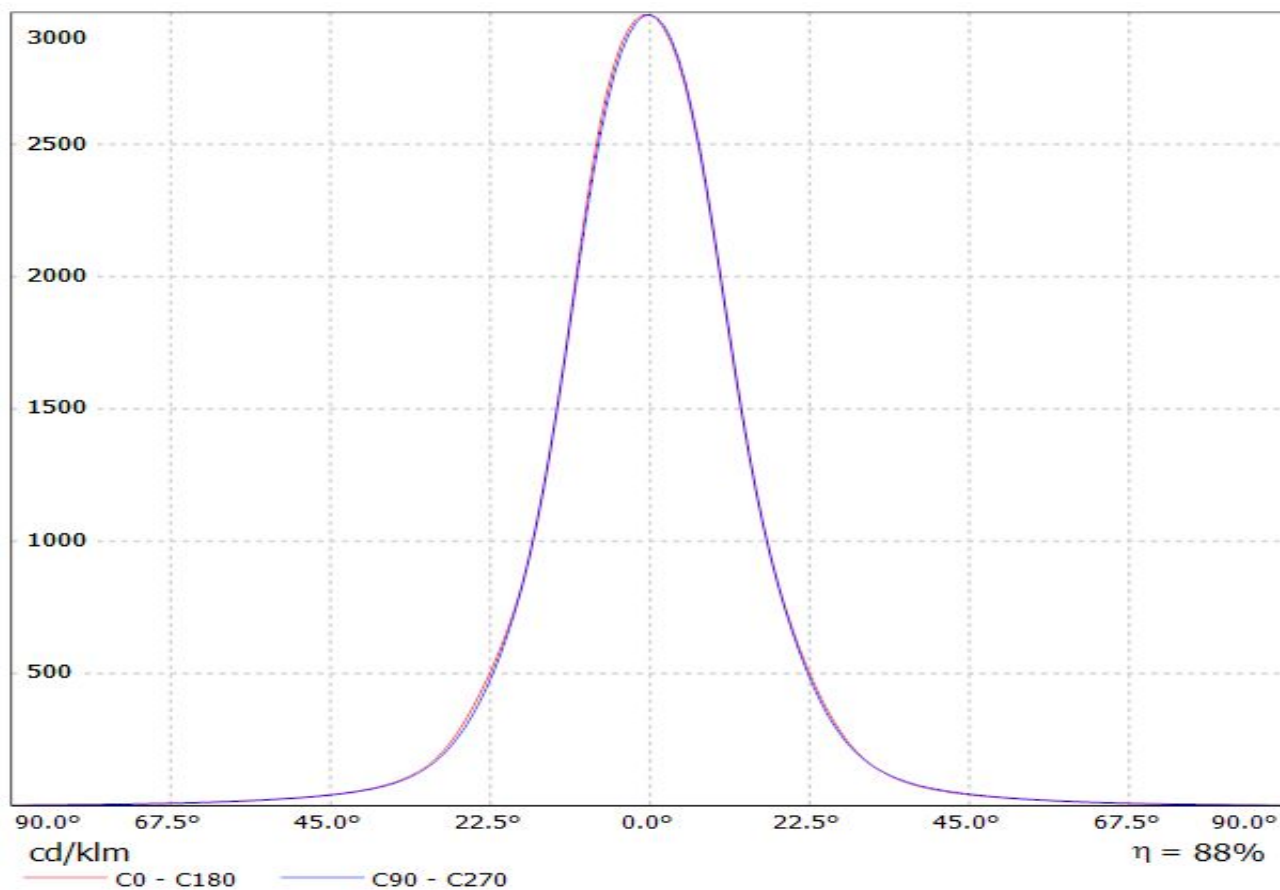

Luminaire: LEDiL Oy LARISA-M_Rebel-ES_(CLIP8&CLIP16) Eff.87.0%
Lamps: 1 x Rebel ES (89.842lm@250mA)

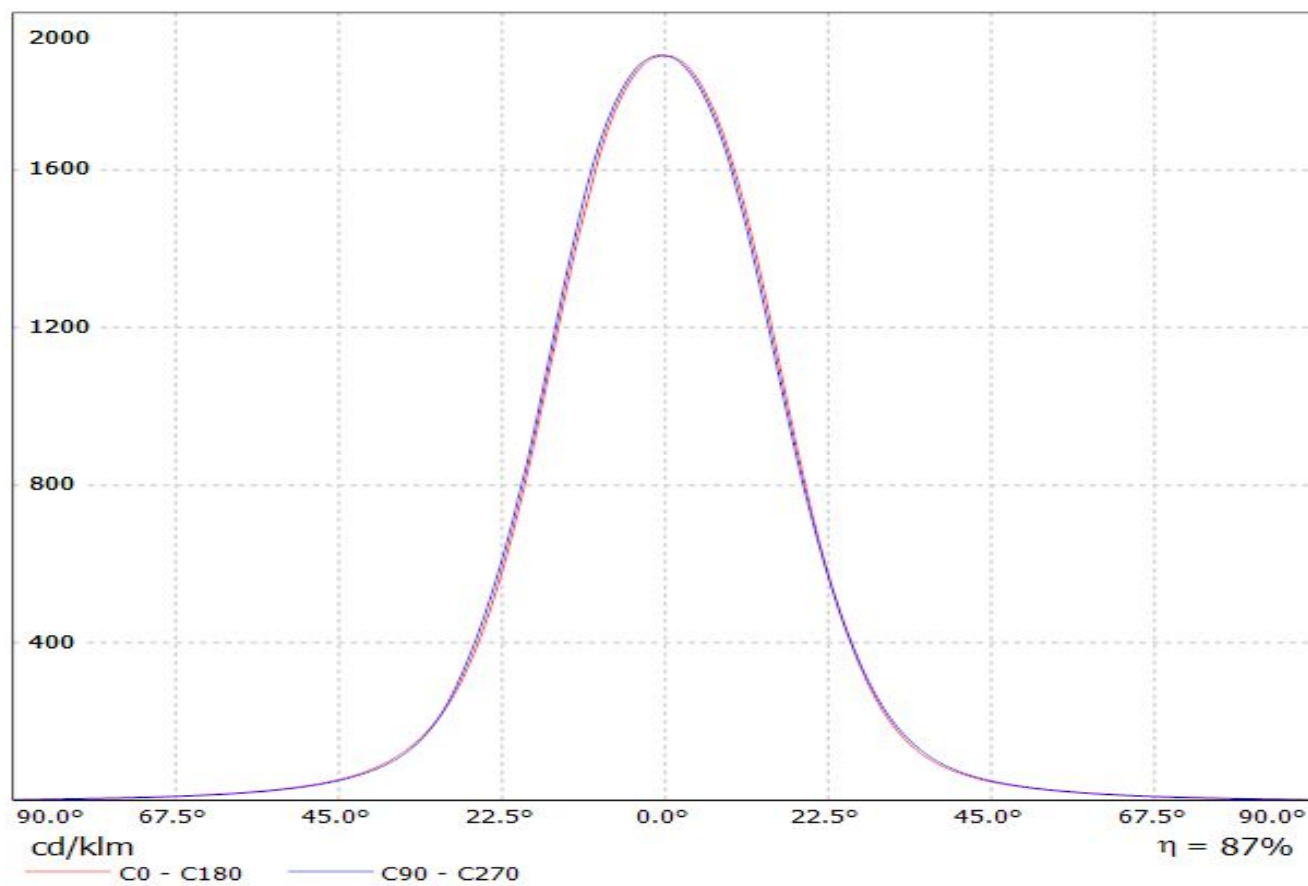

Luminaire: LEDiL Oy LARISA-M_Luxeon_A_(CLIP8&CLIP16) Eff.85.8%
Lamps: 1 x Luxeon A (66.8723lm@250mA)

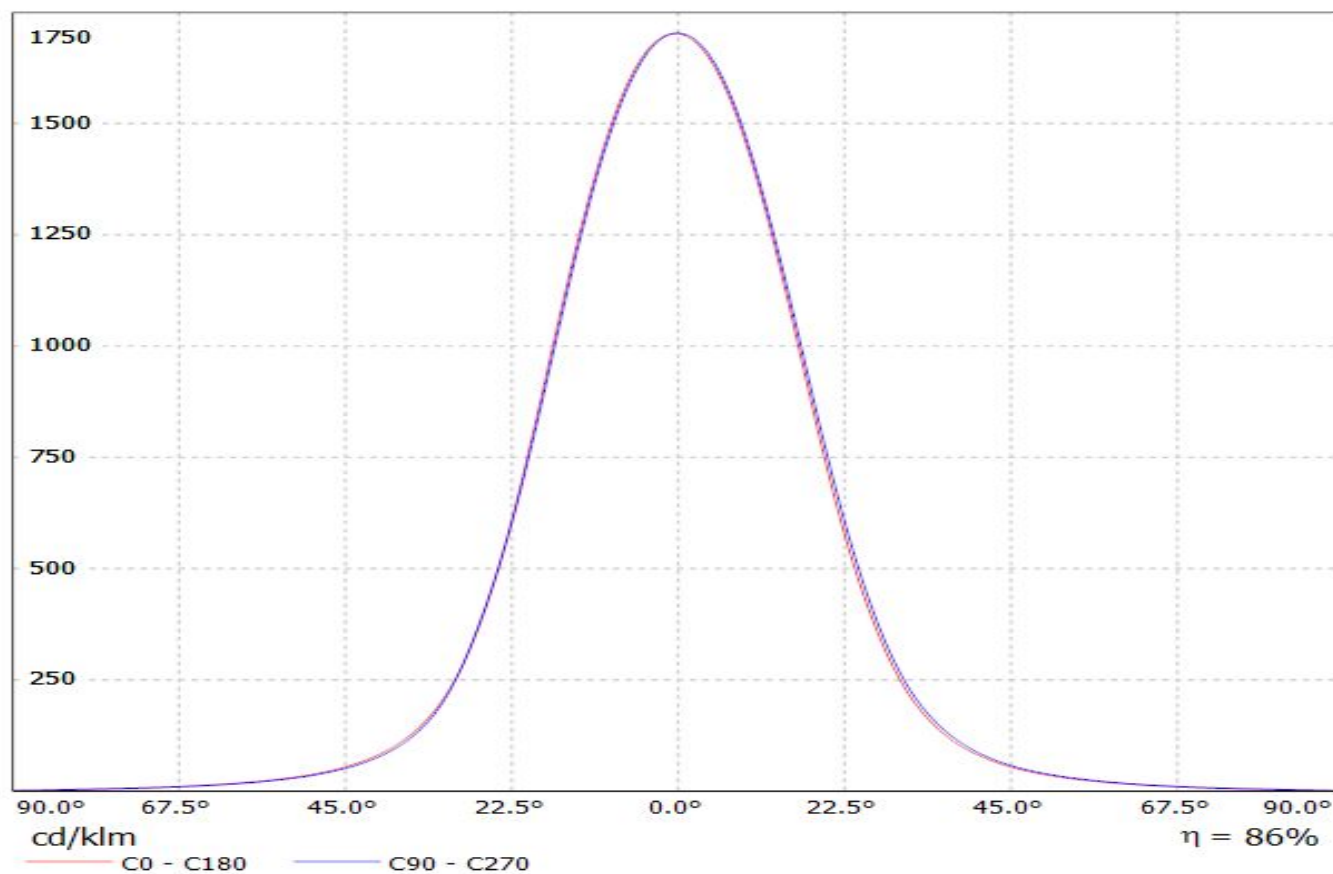

Luminaire: LEDiL Oy CP12941_LARISA-M-CLIP16_(Luxeon_Z_ES)

Lamps: 1 x Philips_Lumileds_Luxeon_Z_ES_(LX22-2790)_51.1518lm@250mA_P=0.73718W_I=249.9mA

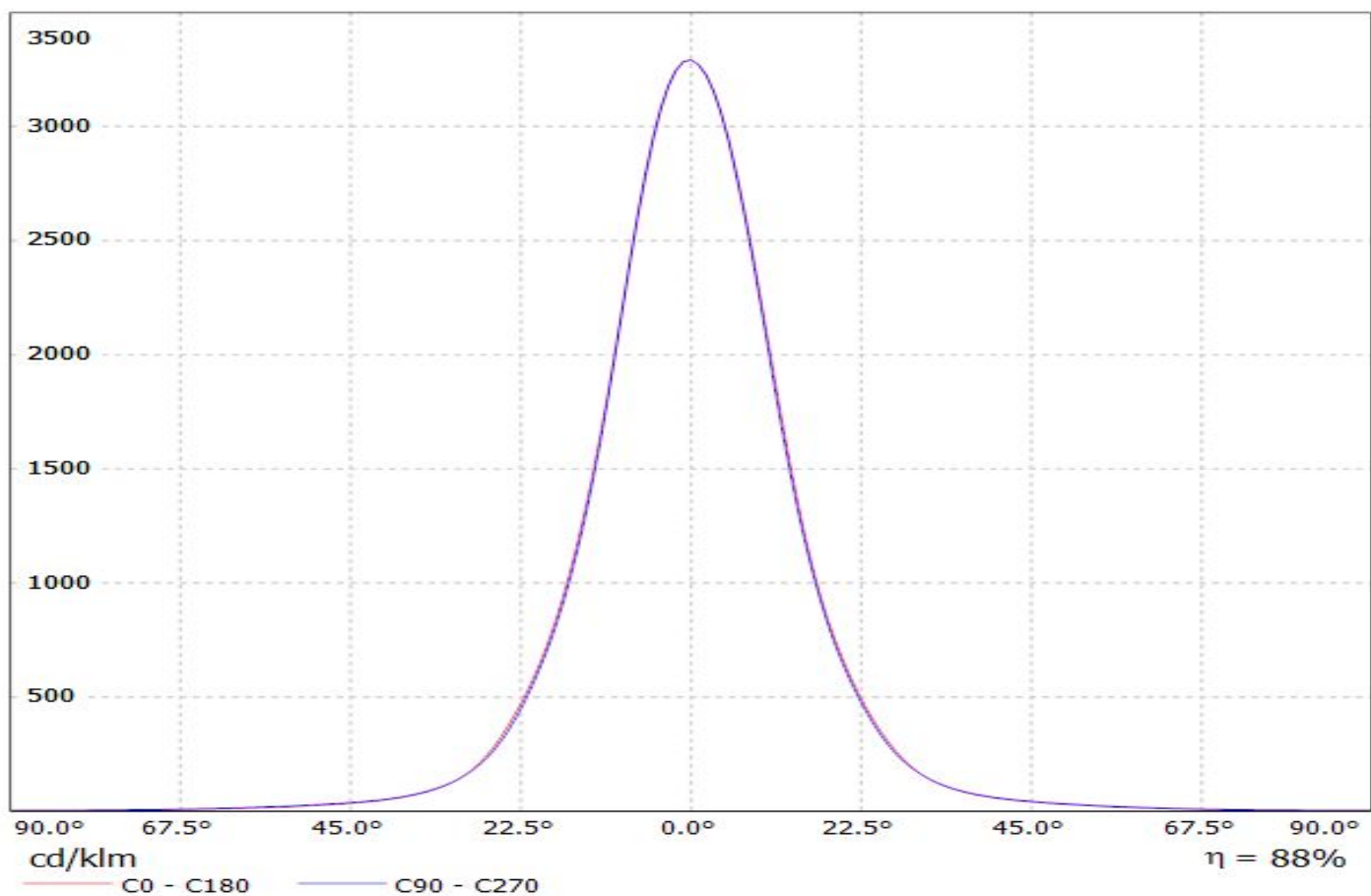

Luminaire: LEDiL Oy CP12941_LARISA-M-CLIP16_(Luxeon_C_WHITE)
Lamps: 1 x Luxeon_C_WHITE_84.9929lm@250mA_P=0.7402W_I=0.250A

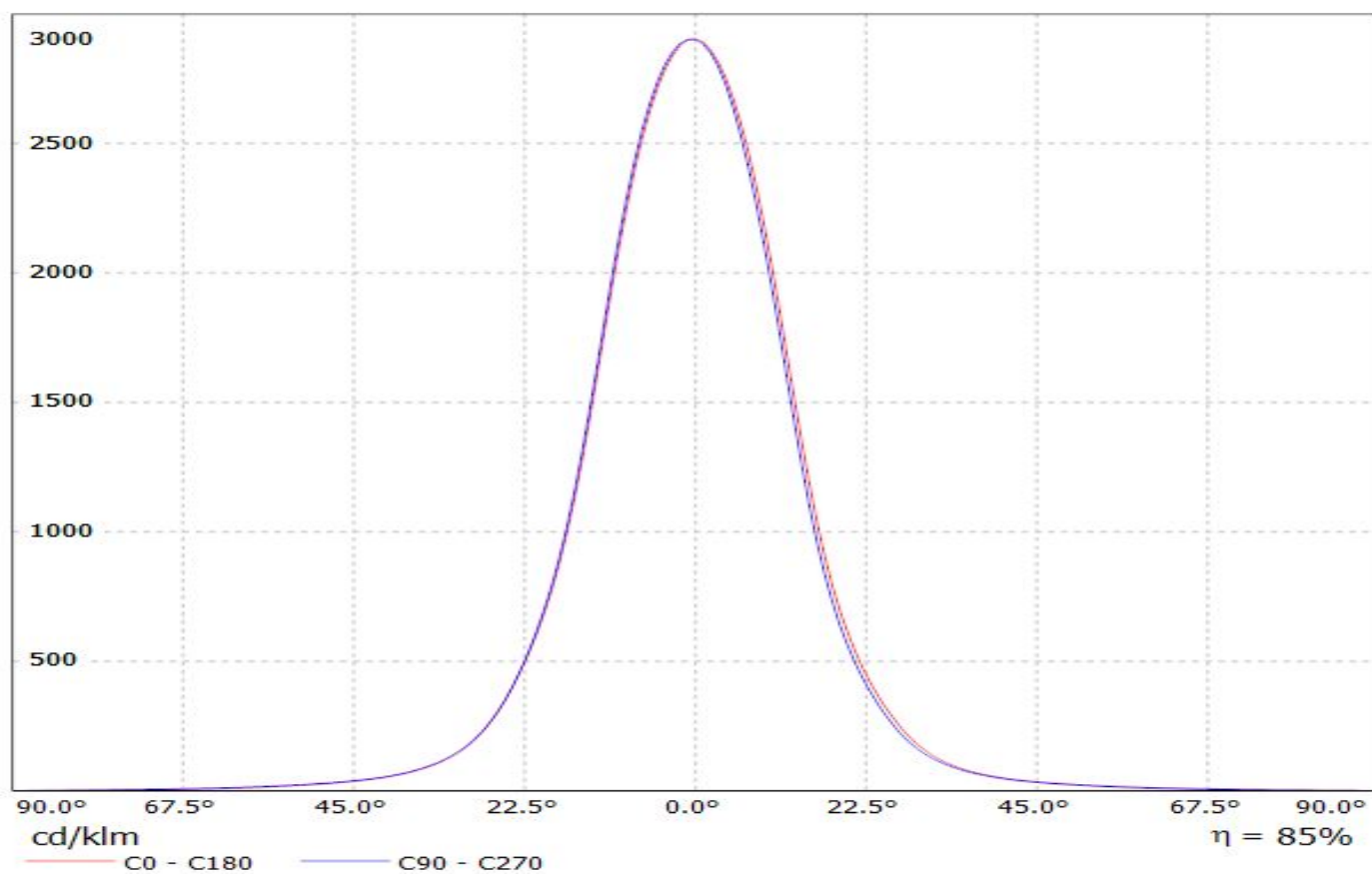

Luminaire: LEDiL Oy LARISA-RS_Luxeon_A_(CLIP8&16) Eff.89.0%
Lamps: 1 x Luxeon A (66.8723lm@250mA)

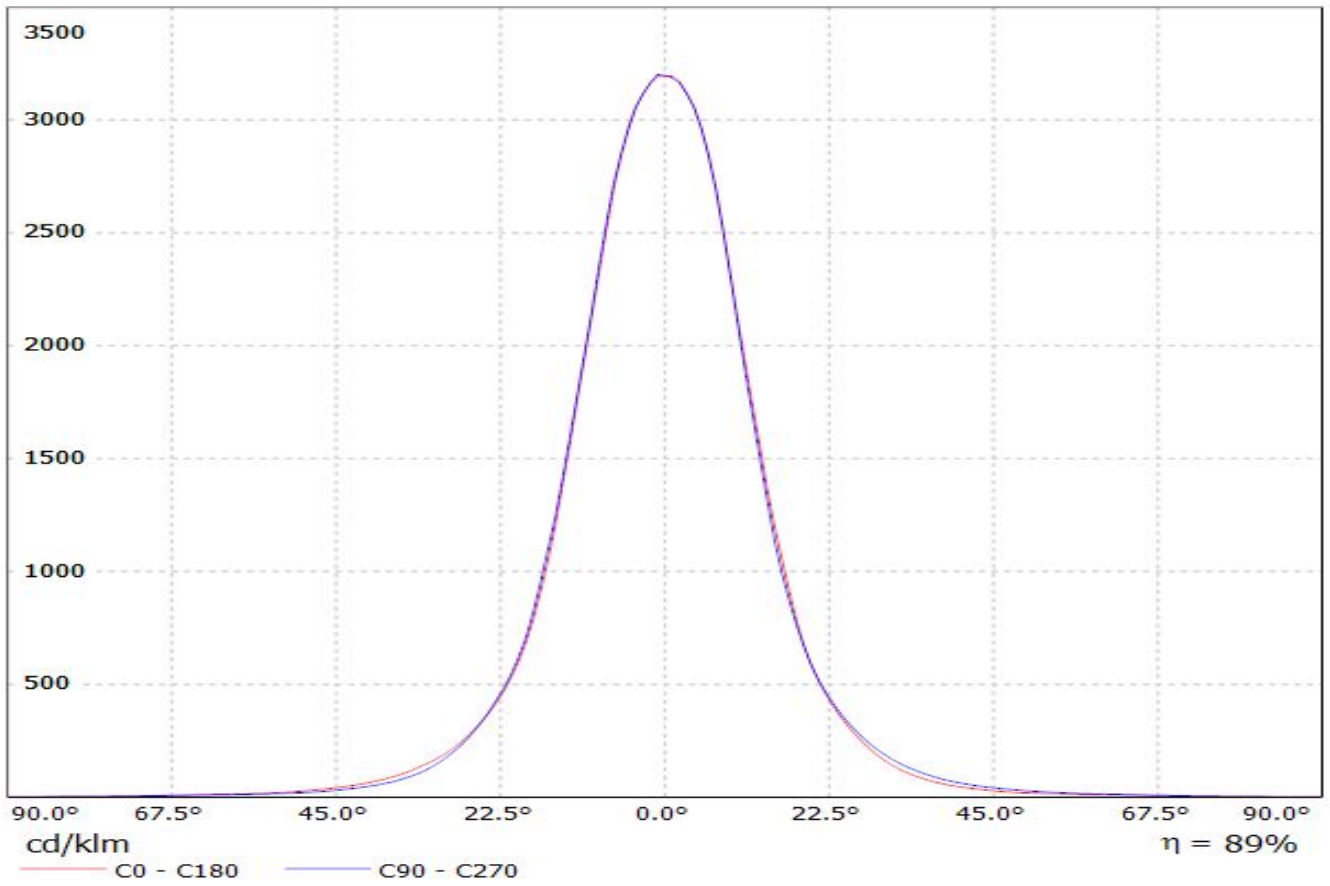

Luminaire: LEDiL Oy LARISA-M_NV519_(CLIP8&CLIP16) Eff.83.5%
Lamps: 1 x NV519 (97.9644lm@250mA)

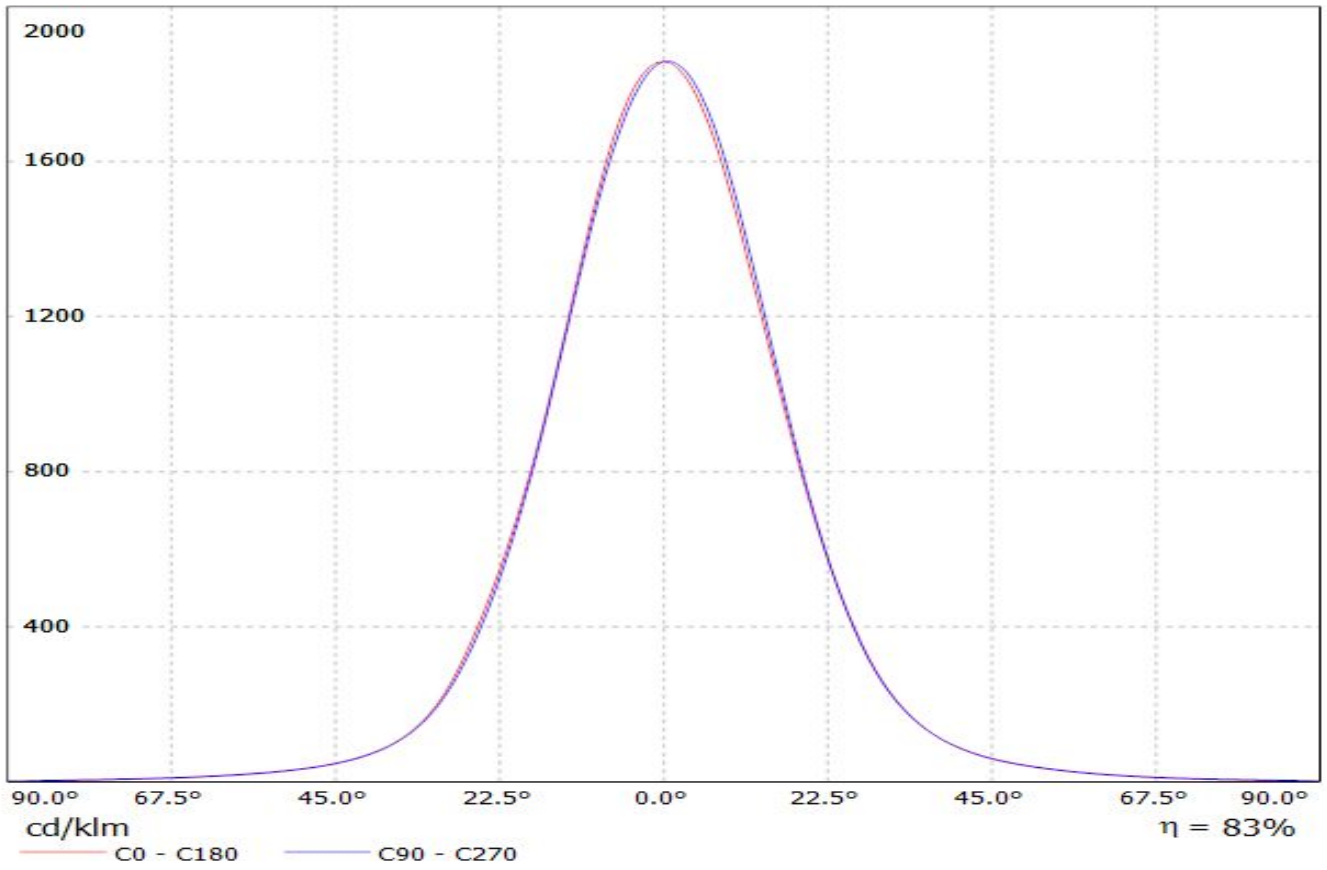

Luminaire: LEDiL Oy LARISA-M_SQ-EC_(CLIP8&CLIP16) Eff.82.8%
Lamps: 1 x SQ-EC (64.5379lm@250mA)

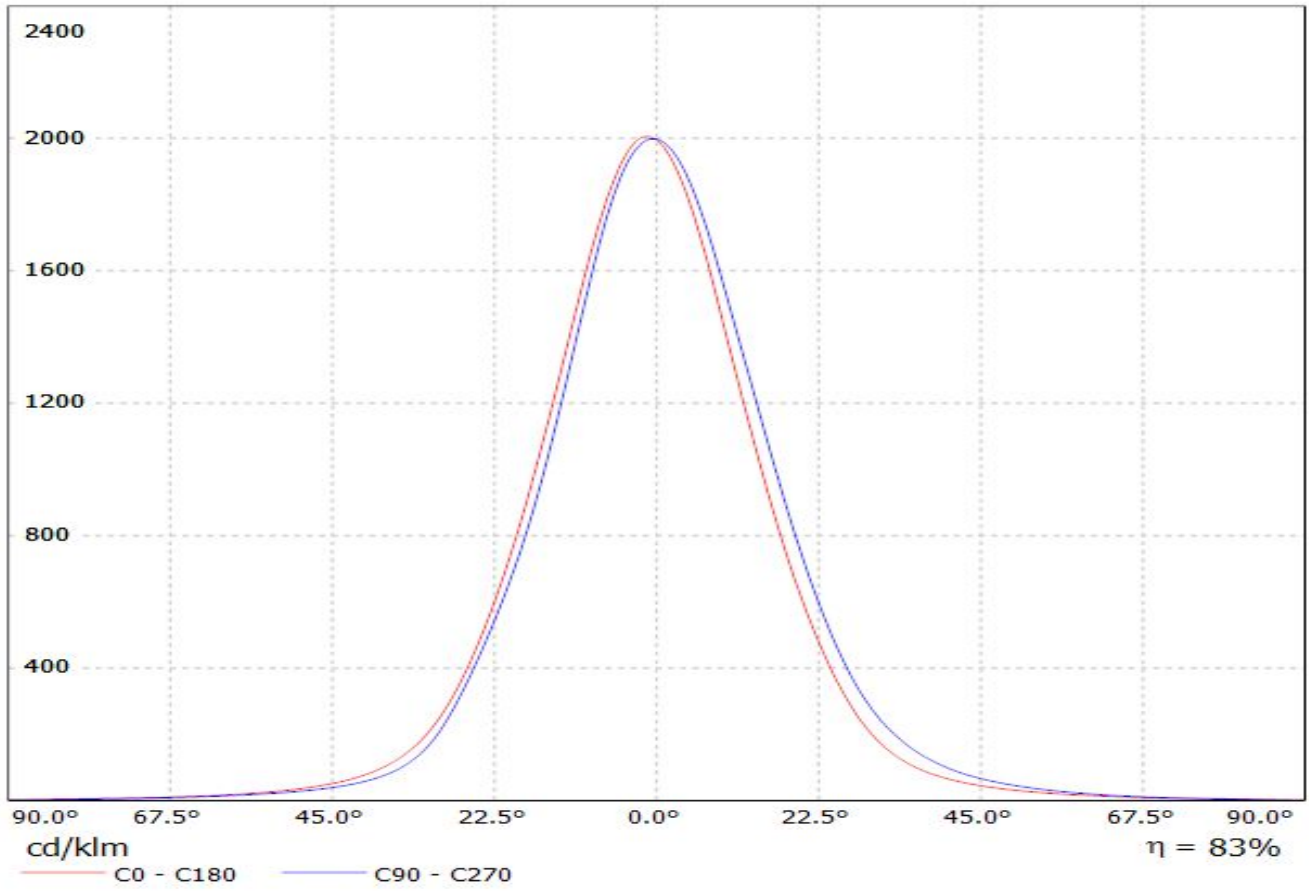

Luminaire: LEDiL Oy LARISA-M_SSL150_(CLIP8&CLIP16) Eff.87.7%
Lamps: 1 x SSL150 (71.2649lm@250mA)

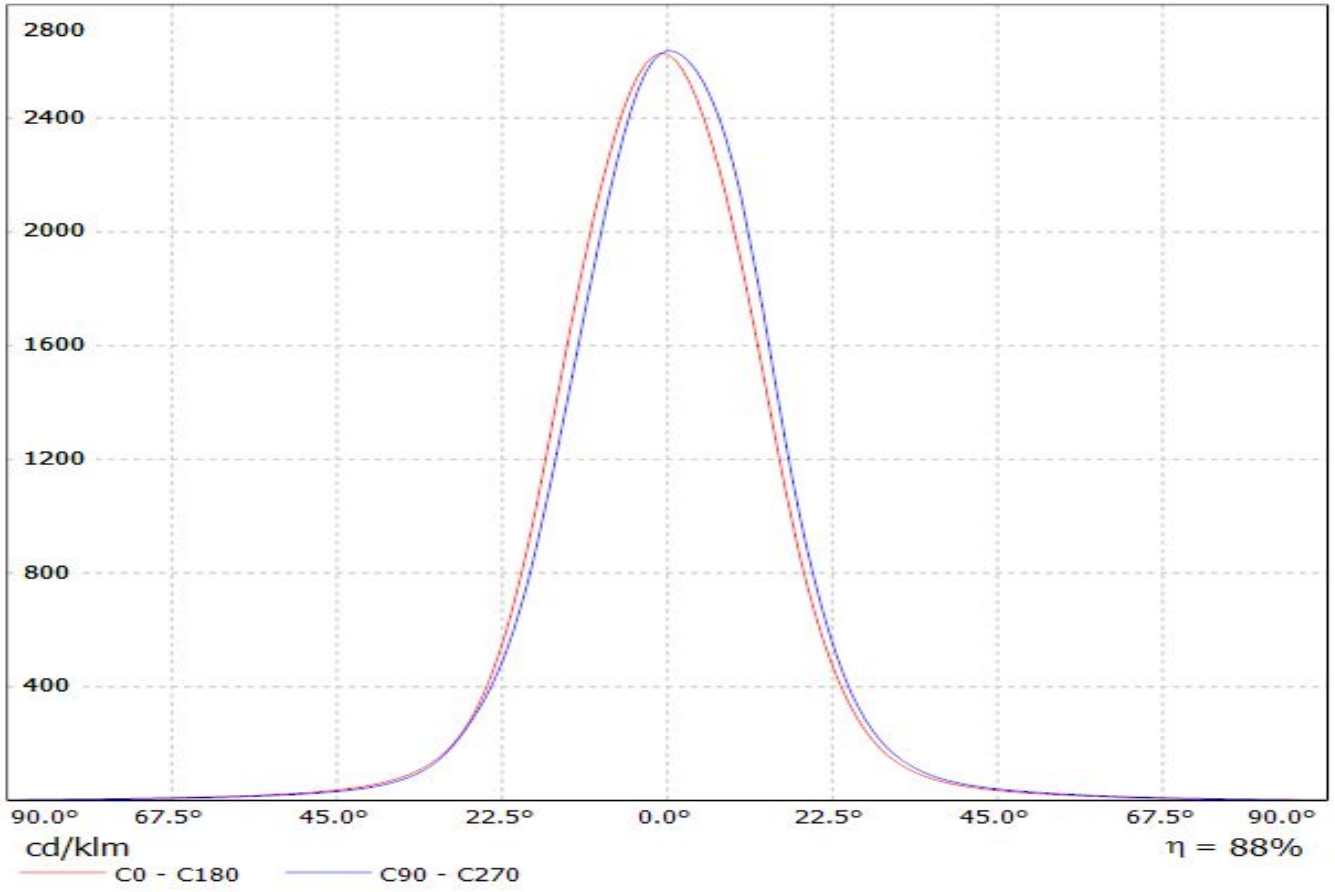

Luminaire: LEDil Oy CP12941_LARISA-M-CLIP16_(Duris_S5) Efficiency=80%
Lamps: 1 x Osram Duris S5 (QW PSLPS1.EC) 102lm @ 150mA CCT=6300K P=1.0W I=150mA

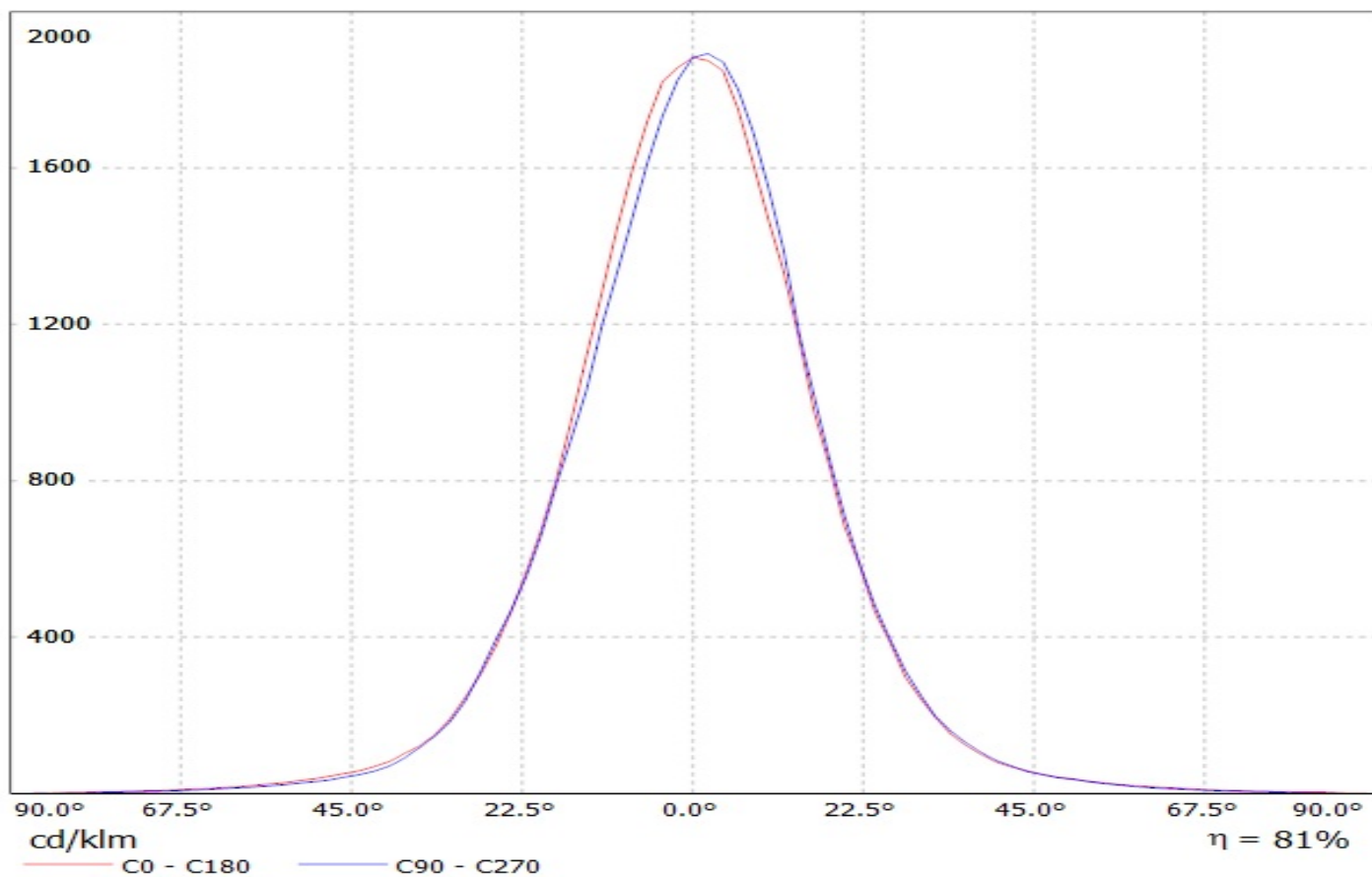

Luminaire: LEDiL Oy LARISA-M_XP-G_(CLIP8&CLIP16) Eff.87.8%
Lamps: 1 x XP-G (62.2075lm@250mA)

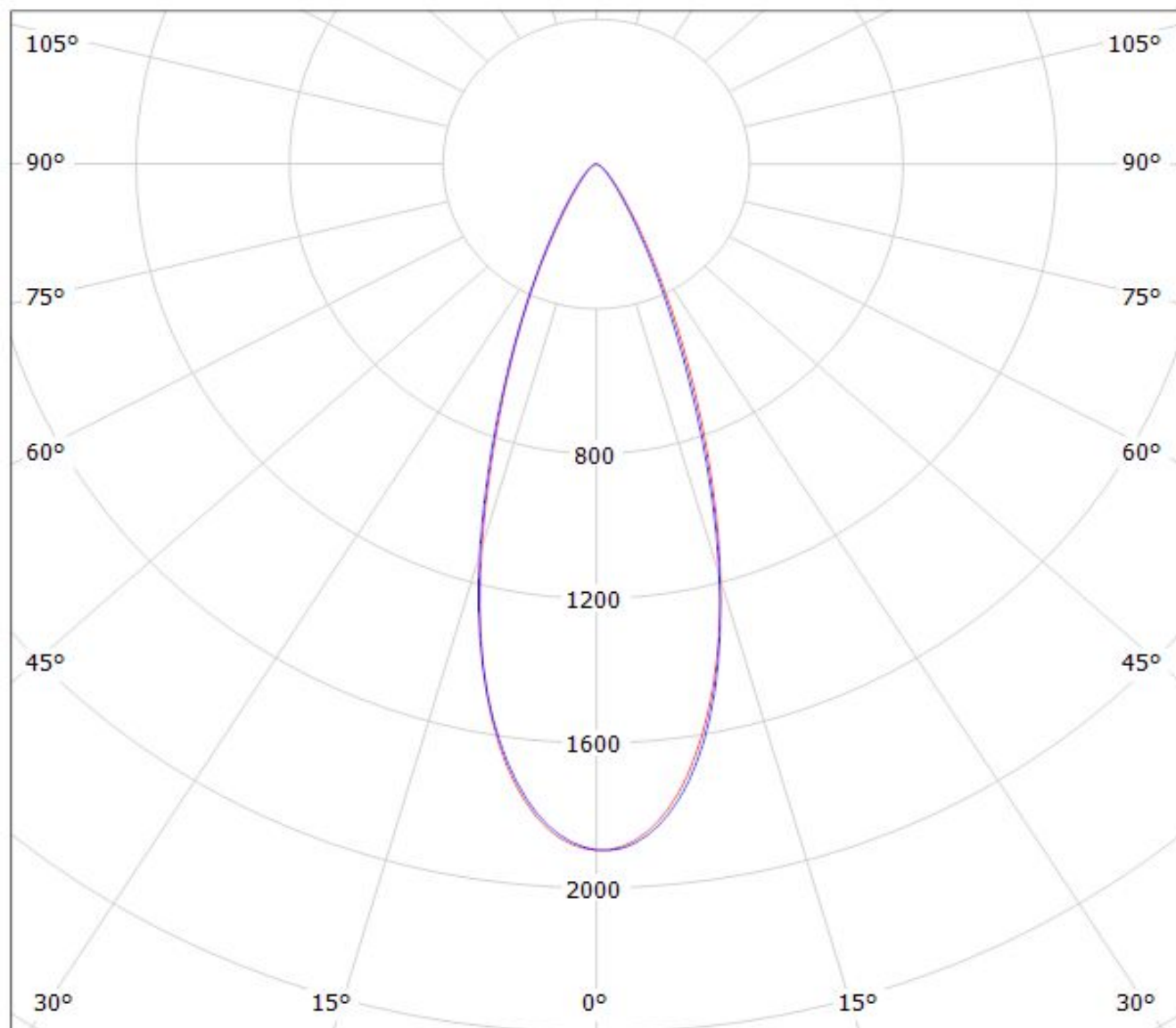

cd/klm

$\eta = 88\%$

— C0 - C180 — C90 - C270

Valaisin: LEDiL Oy LARISA-M_XB-D_(CLIP8&CLIP16) Eff.84.0%
Lamput: 1 x XB-D (91.7428lm@250mA)

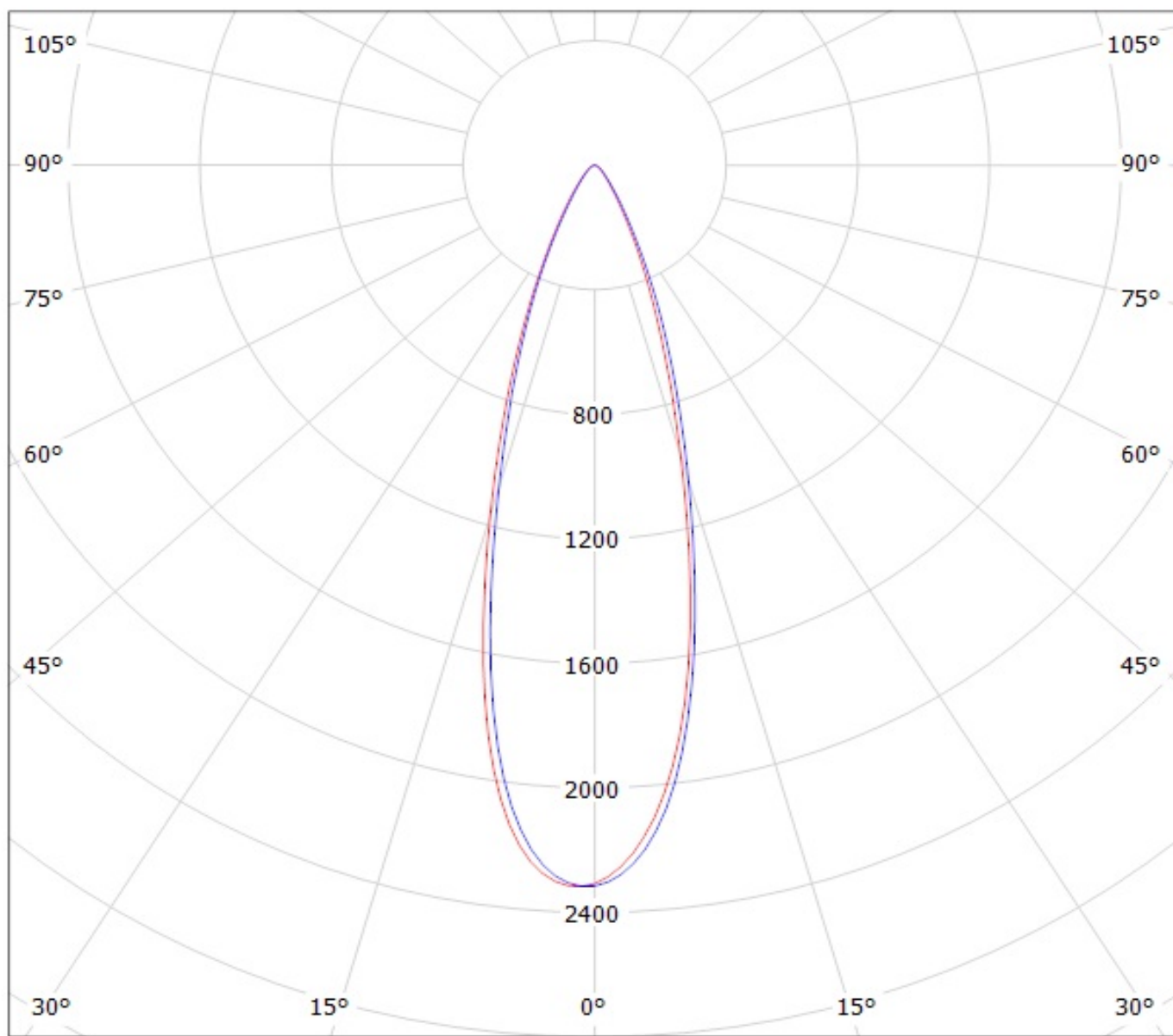

cd/klm

— C0 - C180

— C90 - C270

Luminaire: LEDiL Oy CP12941_LARISA-M-CLIP16_(XQ-E)

Lamps: 1 x Cree_XQ-E_(XQEAWT-0-7B1-Q40-0H-00001_81.2847lm@250mA_P=0.764419W_I=250mA)

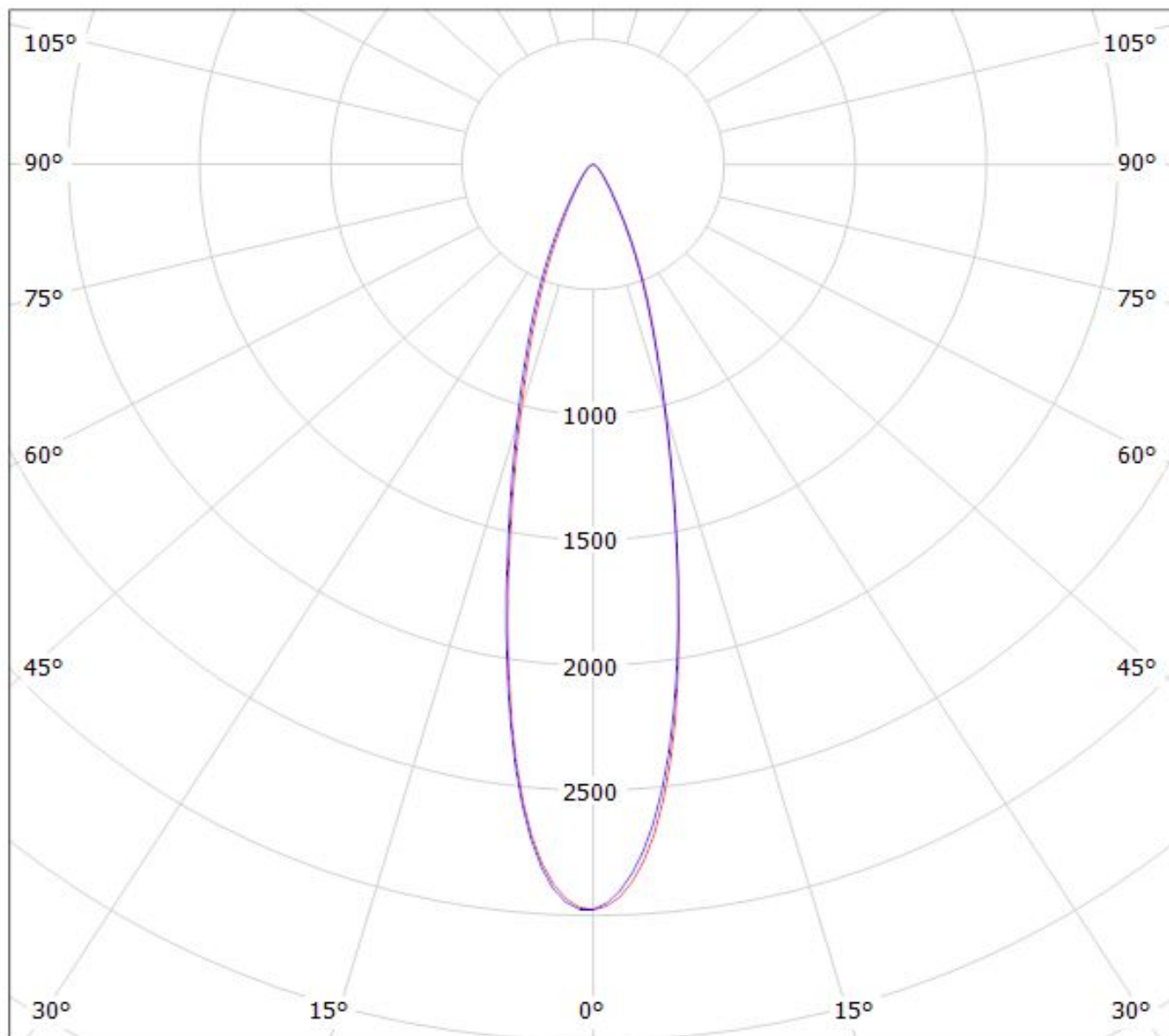

cd/klm

$\eta = 85\%$

— C0 - C180

— C90 - C270

Luminaire: LEDiL Oy CP12941_LARISA-M-CLIP16_(3535_Ceramic) Eff.86.4%
Lamps: 1 x LG 3535 Ceramic (95lm@250mA)

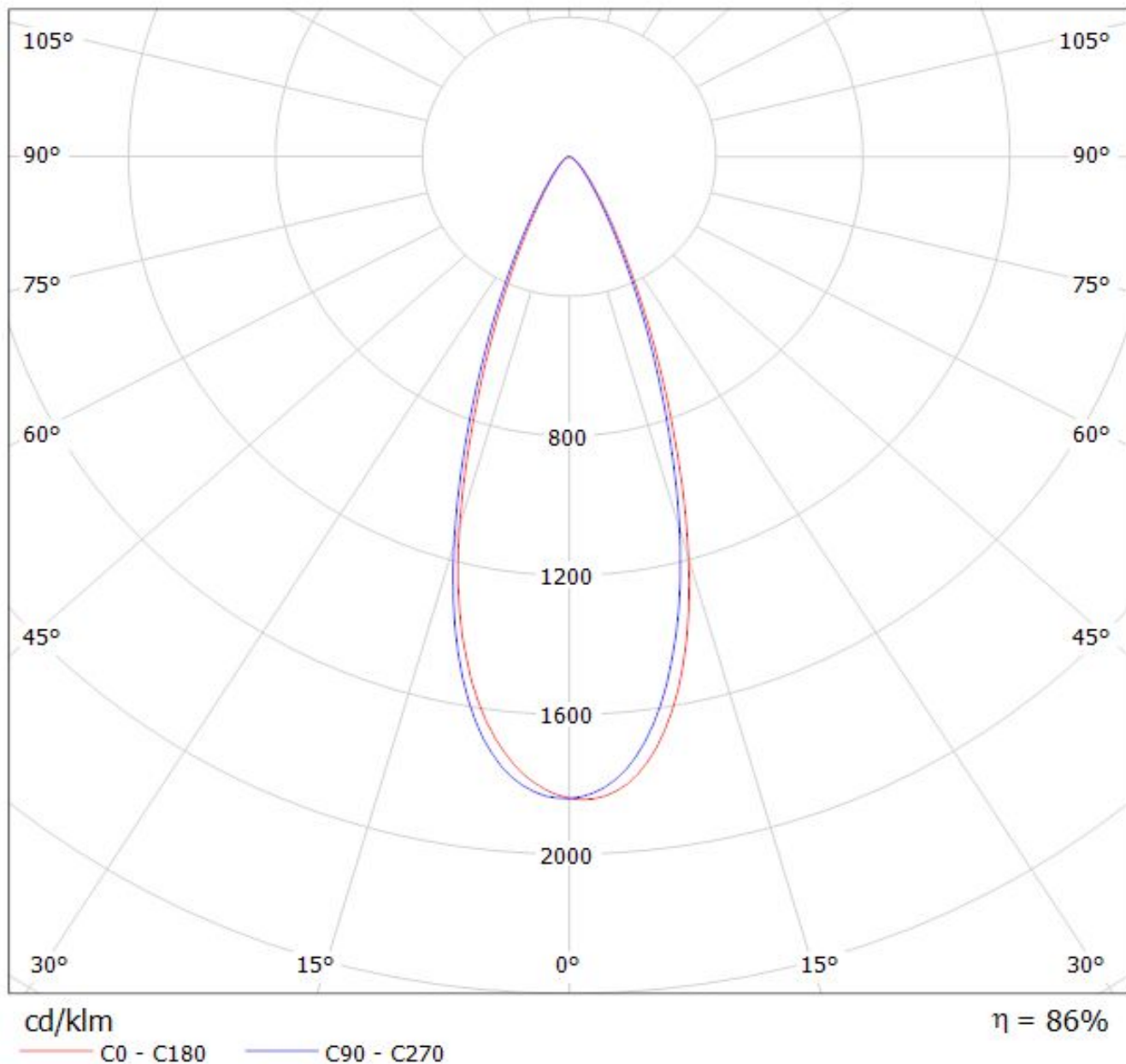

LEDiL Oy CP12940_LARISA-M-CLIP8/CP12941_LARISA-M-CLIP16_ (LG3535_2W) Eff.89.1% / LDC (Polar)

Luminaire: LEDiL Oy CP12940_LARISA-M-CLIP8/CP12941_LARISA-M-CLIP16_(LG3535_2W) Eff.89.1%
Lamps: 1 x LG3535_2W (97.3629lm@250mA)

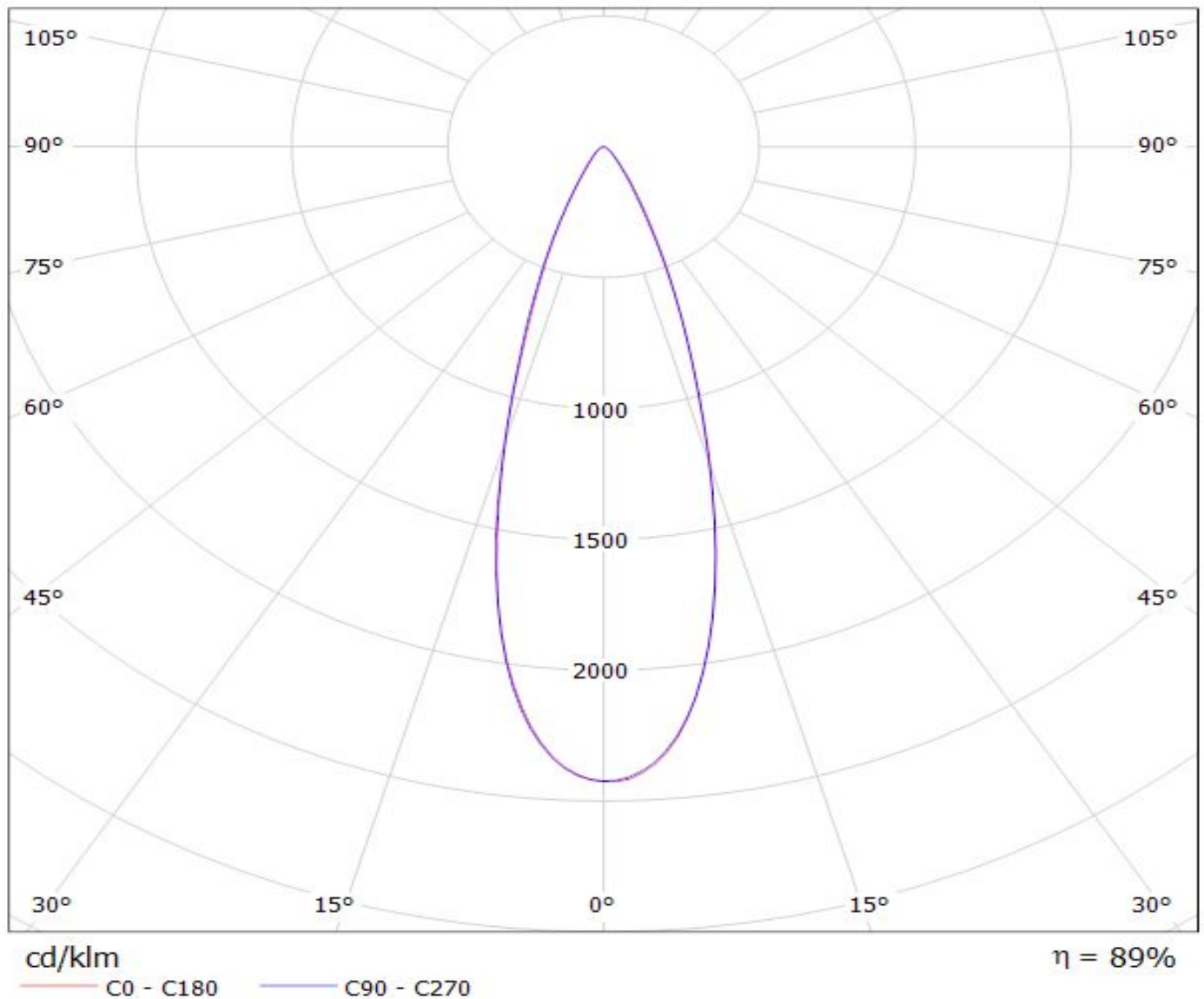

Luminaire: LEDiL Oy LARISA-M_Rebel_(CLIP8&CLIP16) Eff.88.0%
Lamps: 1 x Rebel (80.8775lm@250mA)

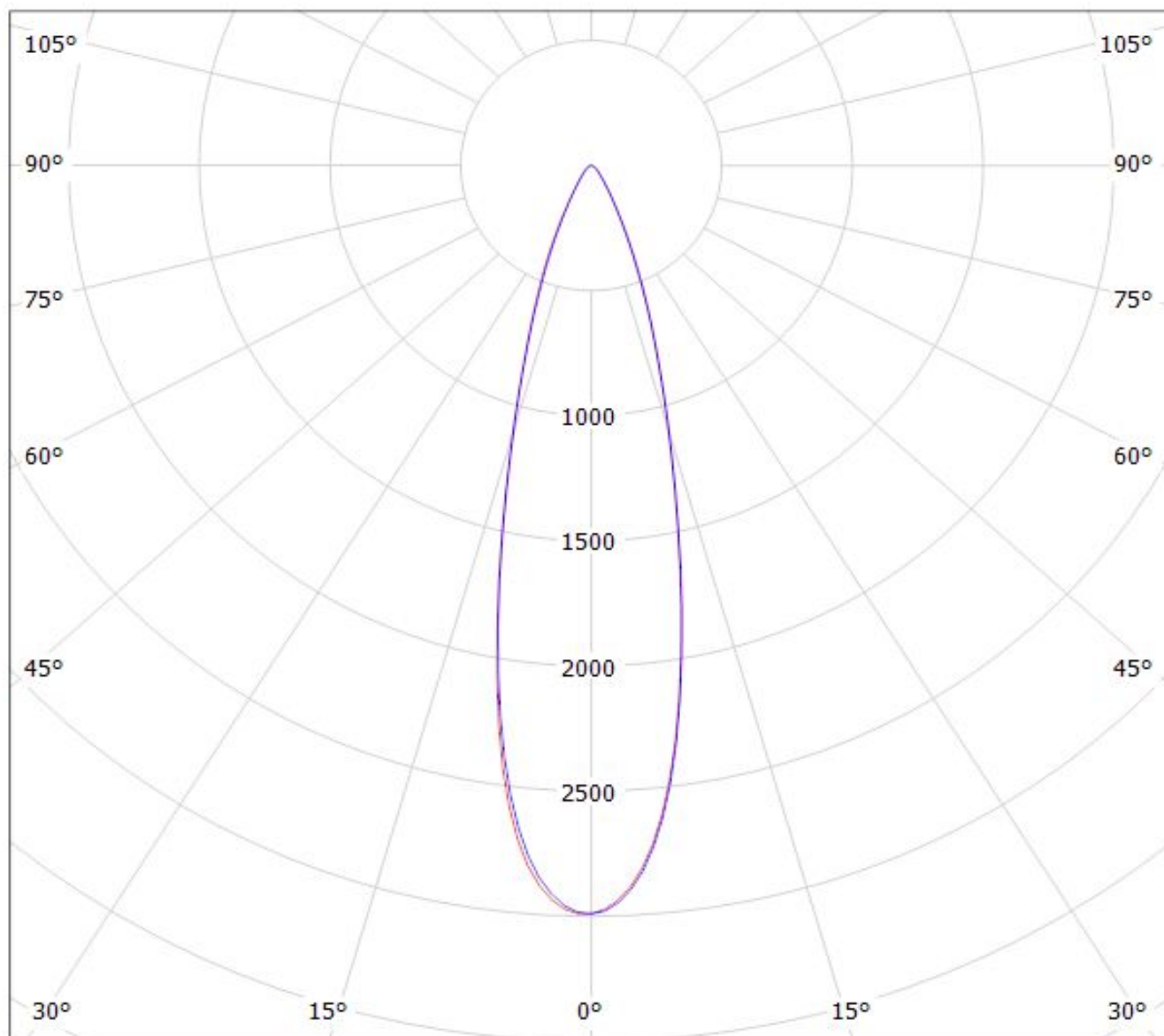

cd/klm

— C0 - C180

— C90 - C270

$\eta = 88\%$

Luminaire: LEDiL Oy LARISA-M_Rebel-ES_(CLIP8&CLIP16) Eff.87.0%
Lamps: 1 x Rebel ES (89.842lm@250mA)

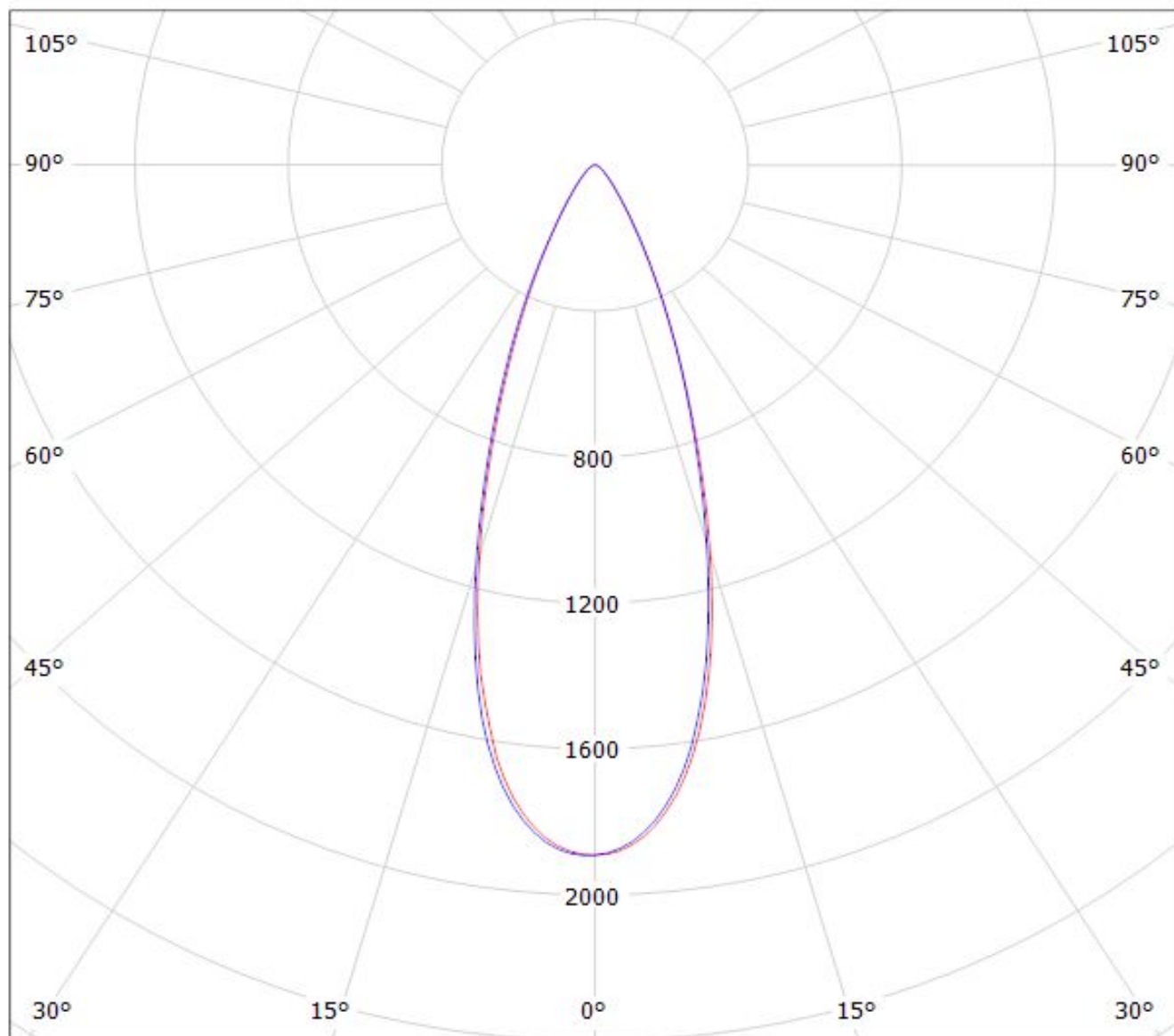

cd/klm
— C0 - C180 — C90 - C270

$\eta = 87\%$

Luminaire: LEDiL Oy LARISA-M_Luxeon_A_(CLIP8&CLIP16) Eff.85.8%
Lamps: 1 x Luxeon A (66.8723lm@250mA)

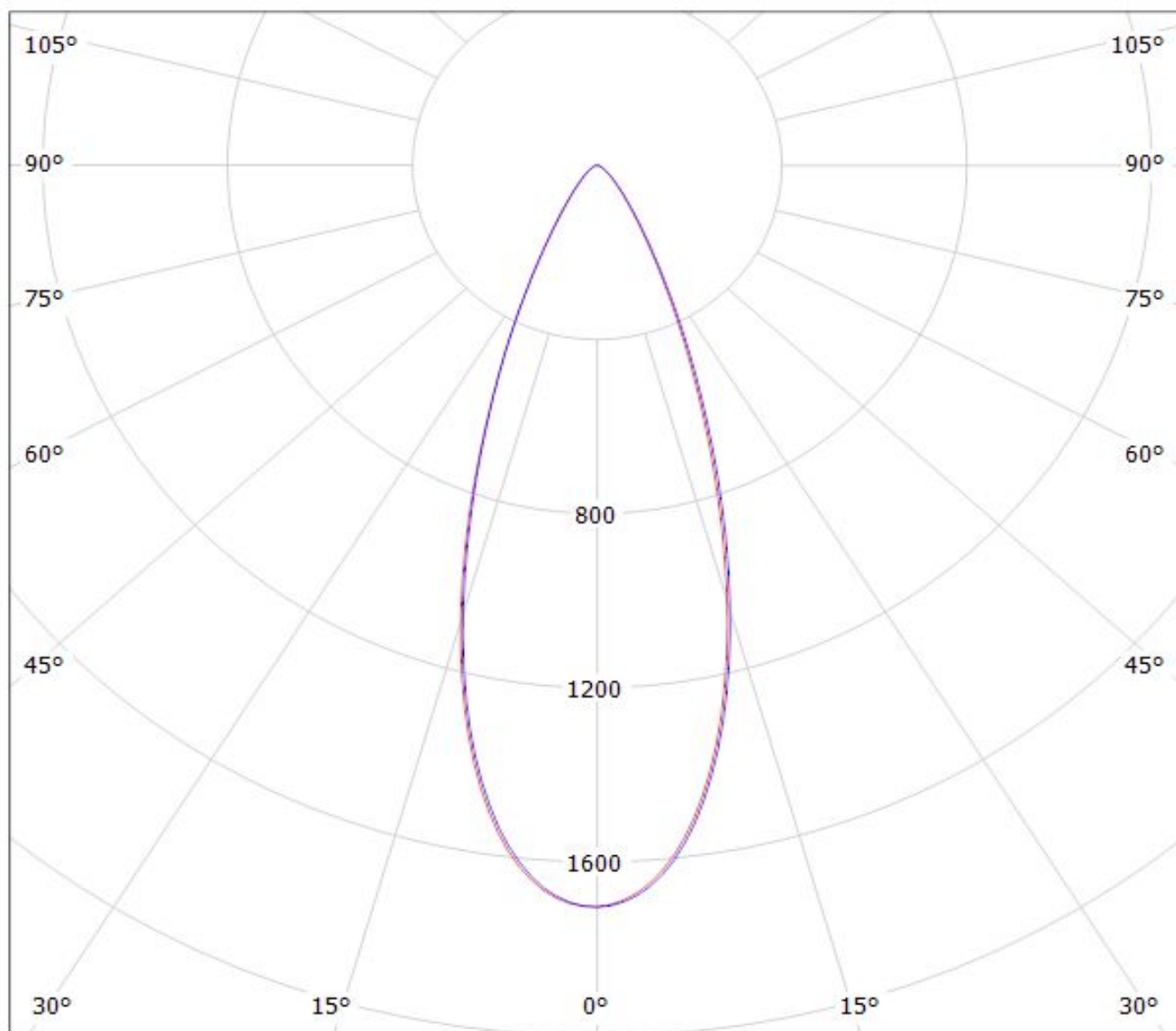

cd/klm

$\eta = 86\%$

— C0 - C180 — C90 - C270

Luminaire: LEDiL Oy CP12941_LARISA-M-CLIP16_(Luxeon_Z_ES)

Lamps: 1 x Philips_Lumileds_Luxeon_Z_ES_(LXZ2-2790)_51.1518lm@250mA_P=0.73718W_I=249.9mA

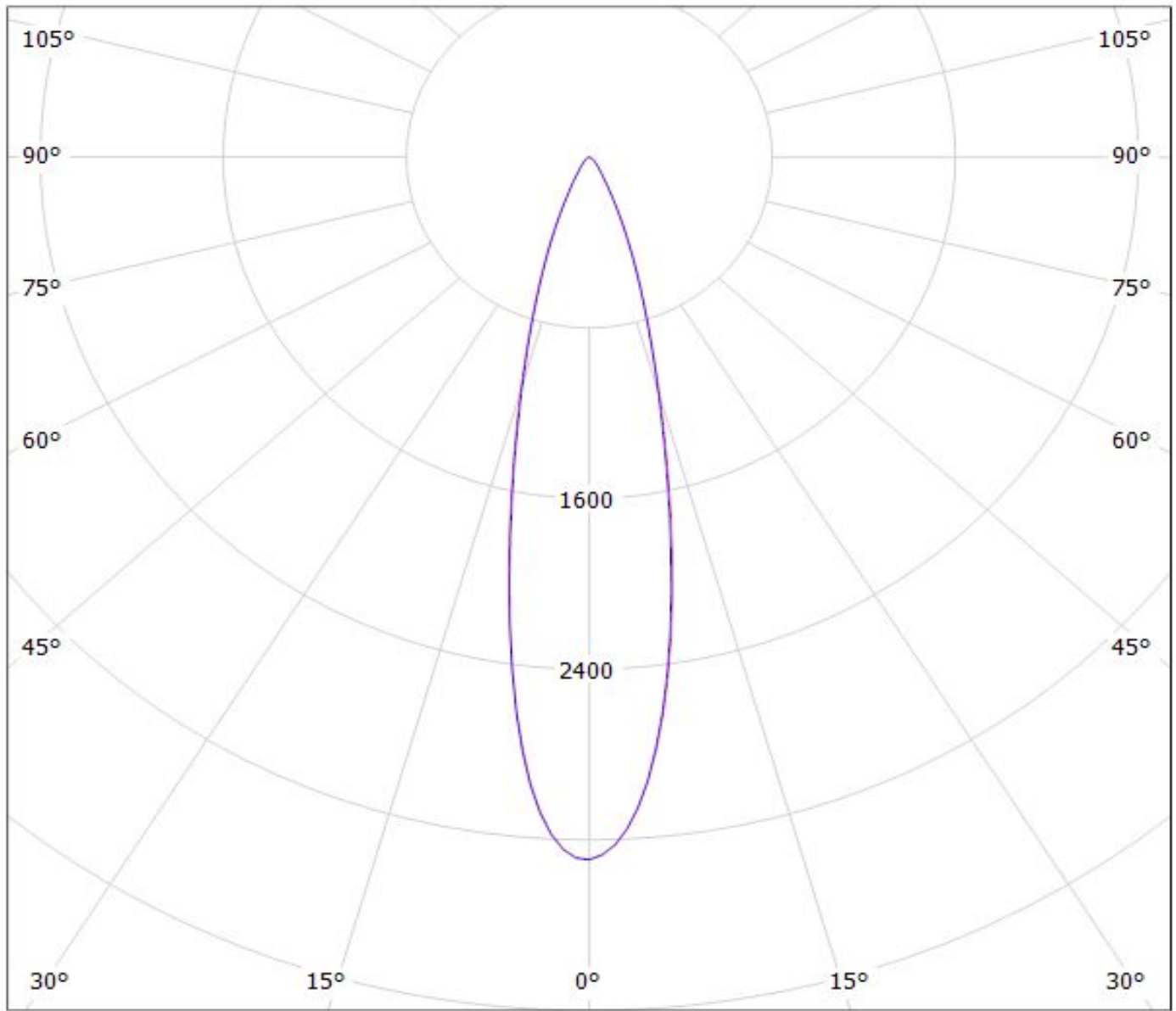

cd/klm

$\eta = 88\%$

— C0 - C180

— C90 - C270

Luminaire: LEDiL Oy CP12941_LARISA-M-CLIP16_(Luxeon_C_WHITE)
Lamps: 1 x Luxeon_C_WHITE_84.9929lm@250mA_P=0.7402W_I=0.250A

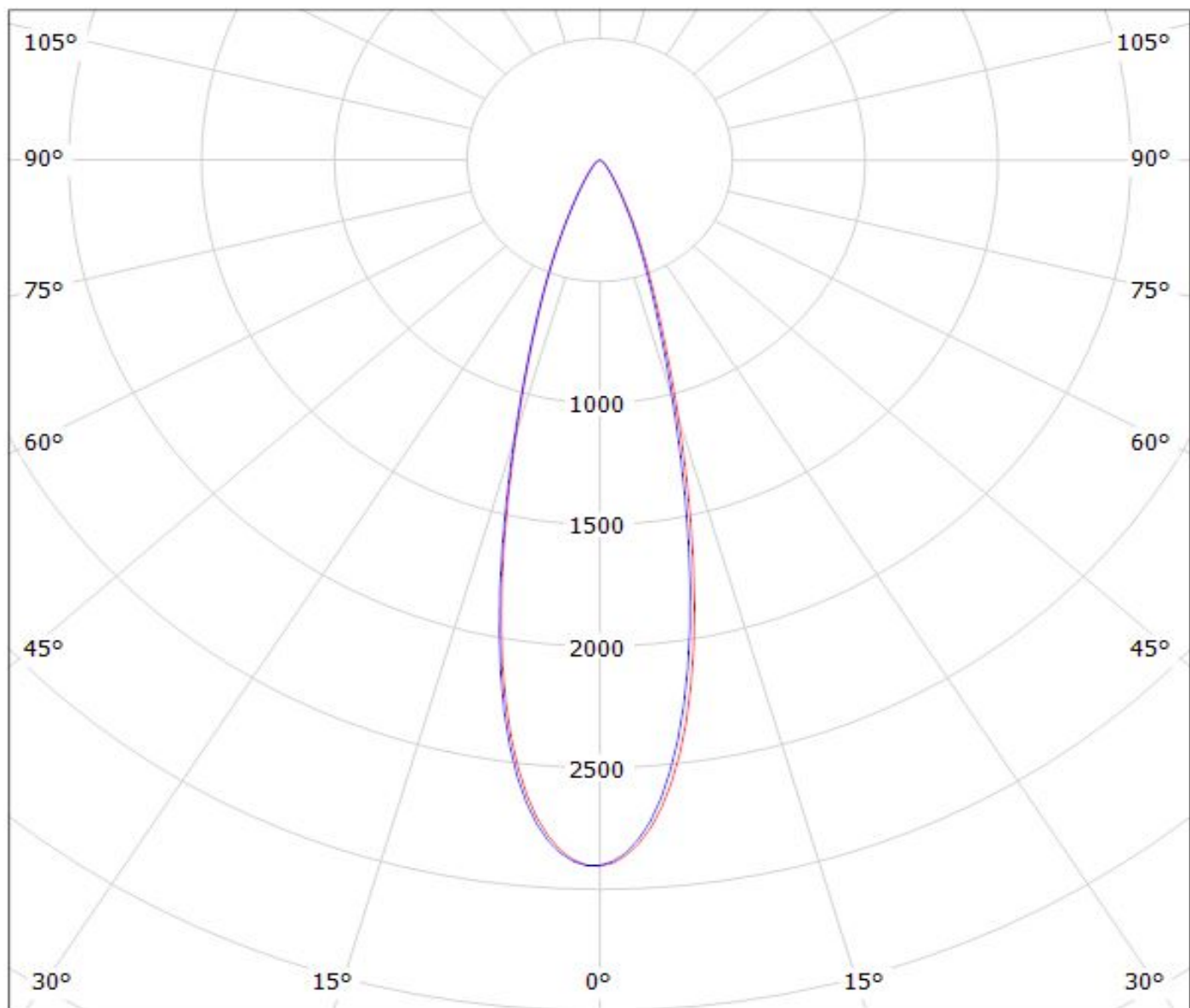

cd/klm

— C0 - C180 — C90 - C270

$\eta = 85\%$

Luminaire: LEDiL Oy LARISA-RS_Luxeon_A_(CLIP8&16) Eff.89.0%
Lamps: 1 x Luxeon A (66.8723lm@250mA)

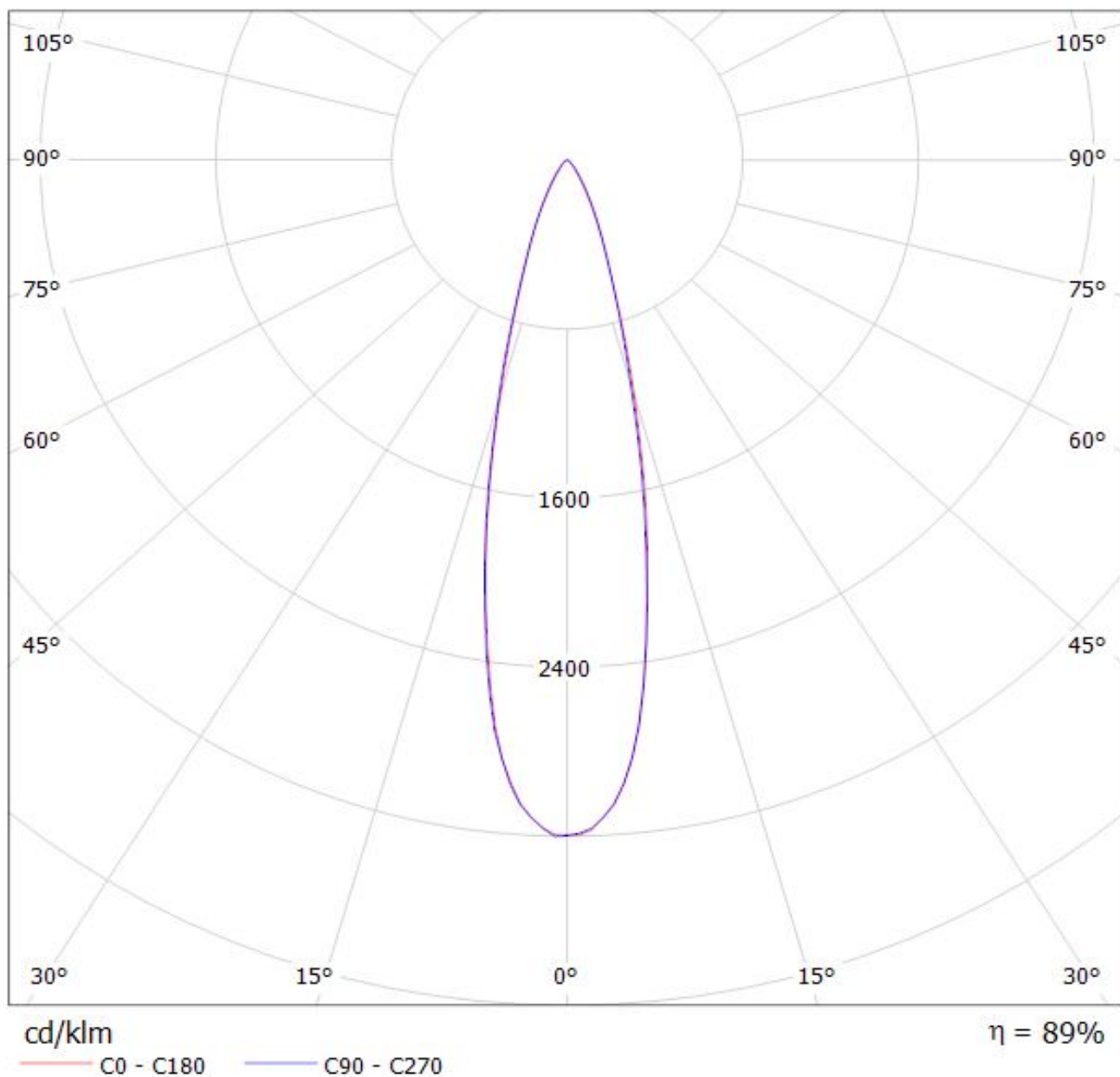

Luminaire: LEDiL Oy LARISA-M_NV519_(CLIP8&CLIP16) Eff.83.5%
Lamps: 1 x NV519 (97.9644lm@250mA)

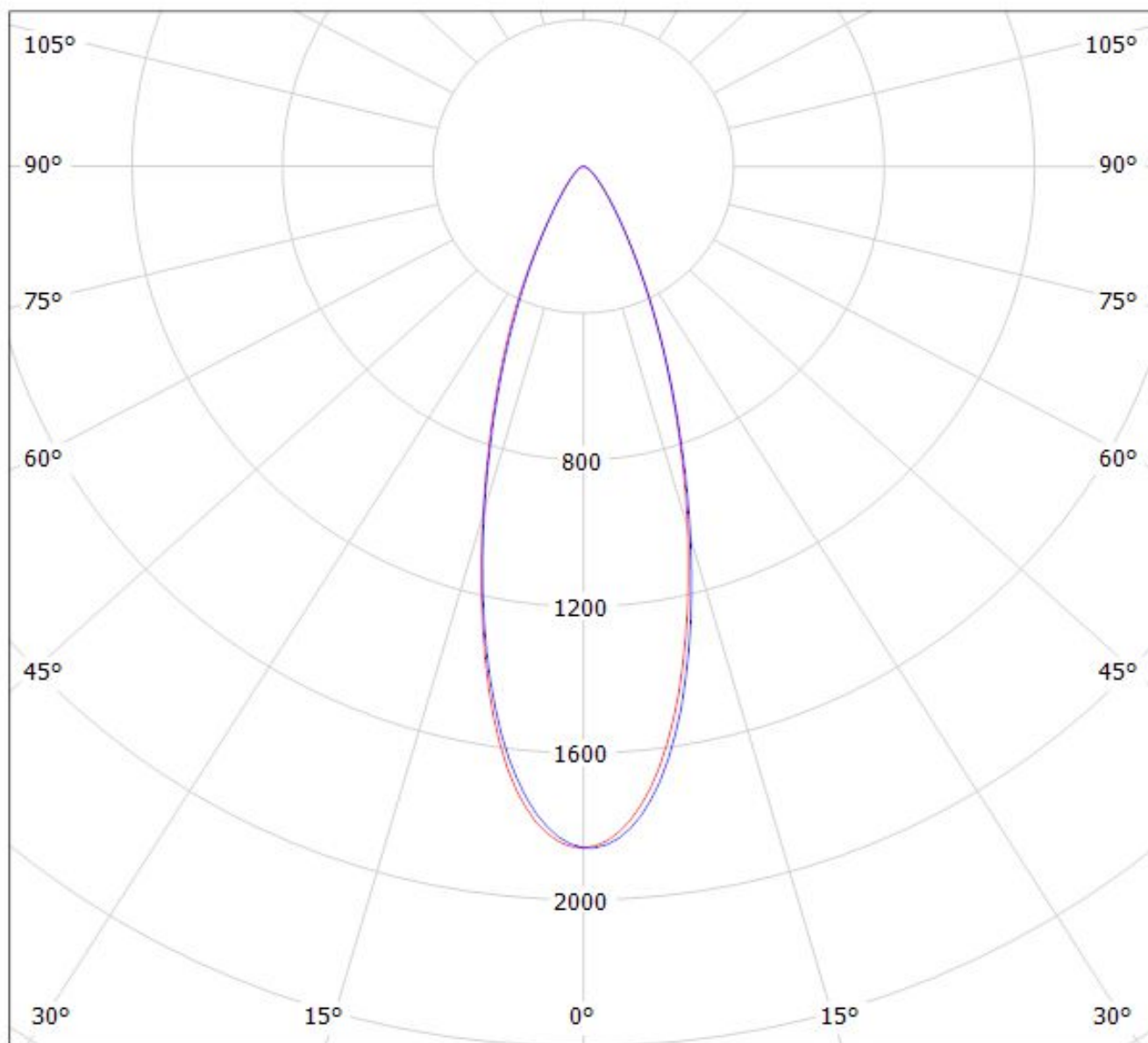

cd/klm

— C0 - C180

— C90 - C270

$\eta = 83\%$

Luminaire: LEDiL Oy LARISA-M_SQ-EC_(CLIP8&CLIP16) Eff.82.8%
Lamps: 1 x SQ-EC (64.5379lm@250mA)

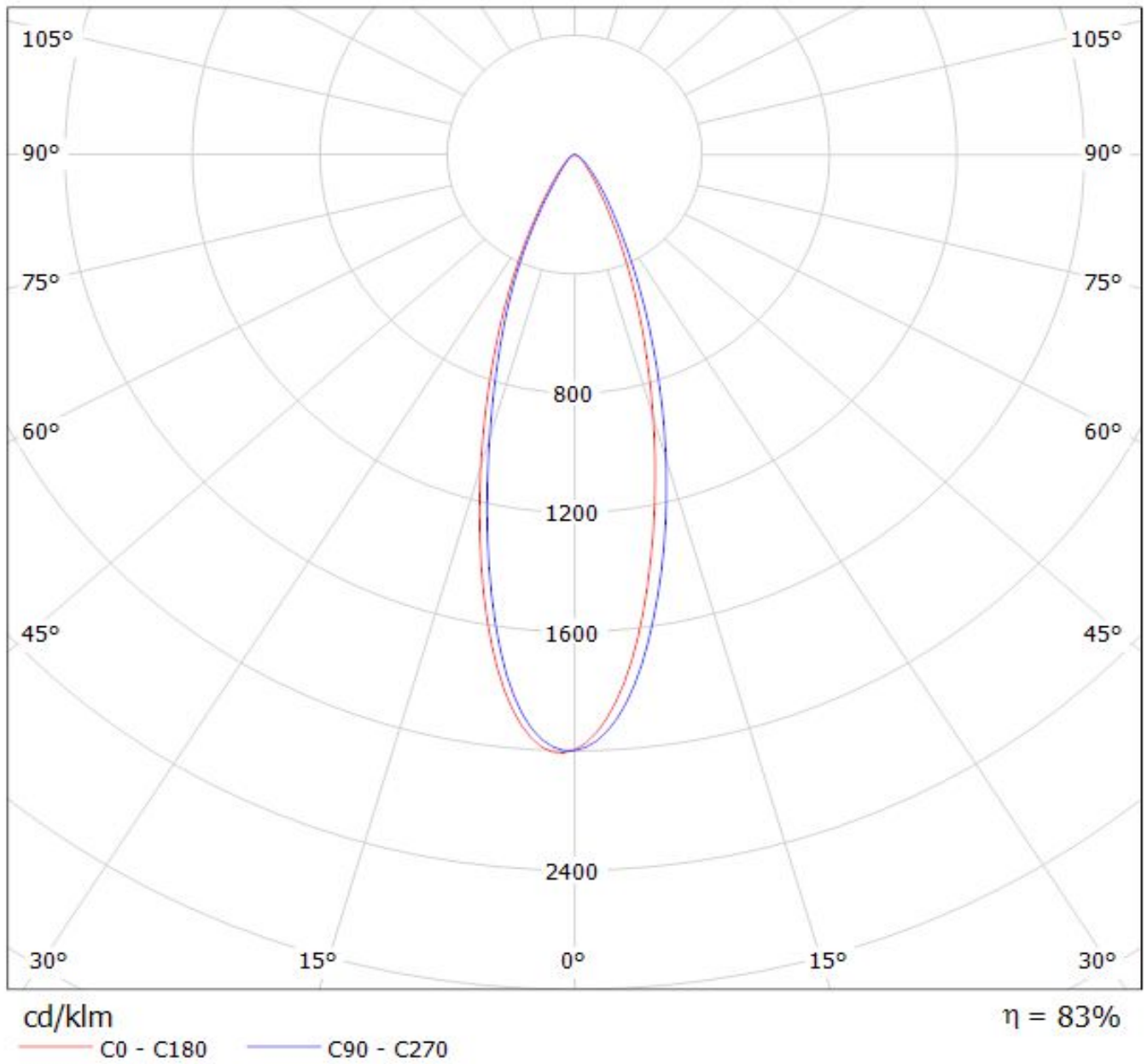

Luminaire: LEDiL Oy LARISA-M_SSL150_(CLIP8&CLIP16) Eff.87.7%
Lamps: 1 x SSL150 (71.2649lm@250mA)

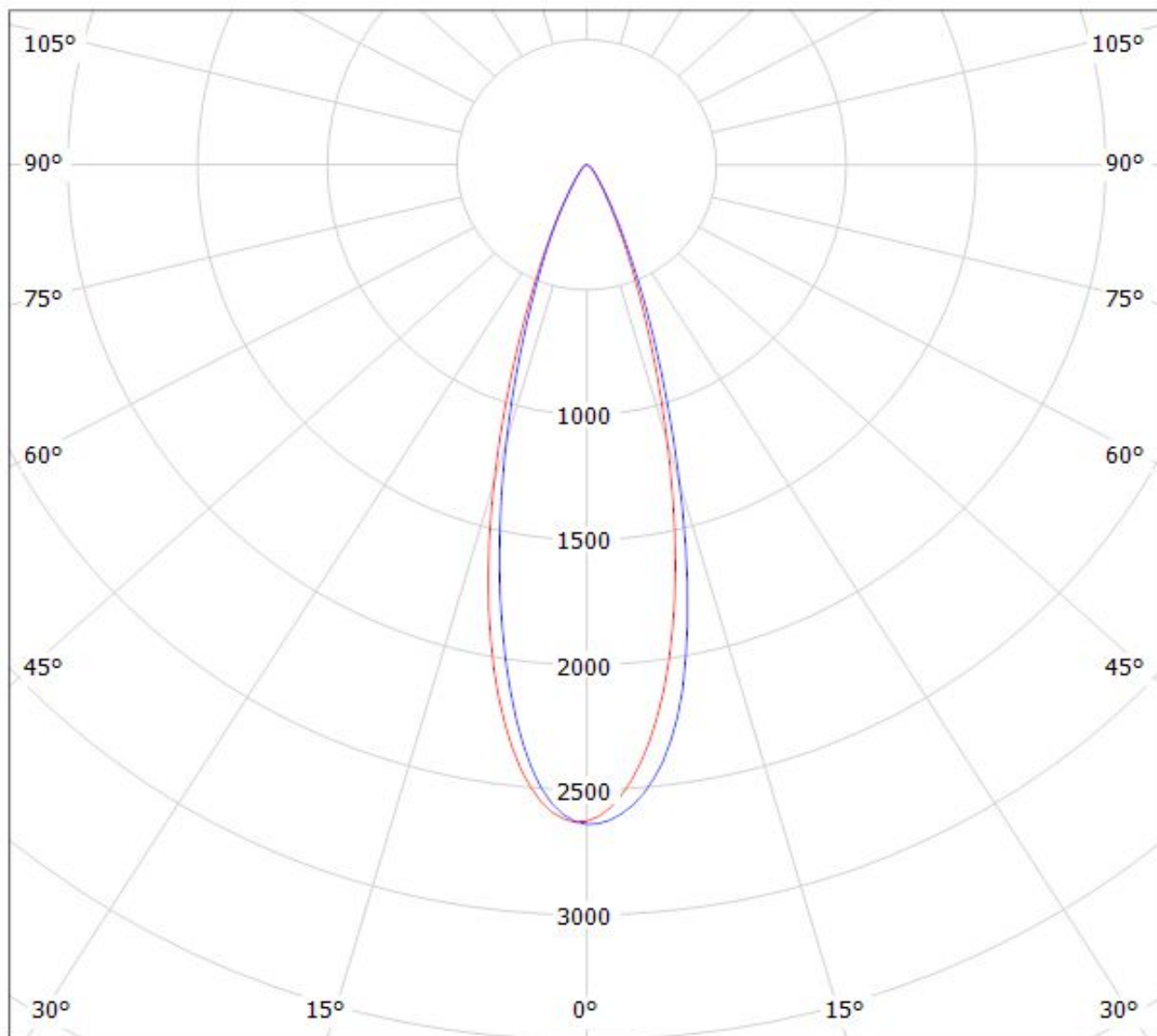

cd/klm

$\eta = 88\%$

— C0 - C180

— C90 - C270

Luminaire: LEDil Oy CP12941_LARISA-M-CLIP16_(Duris_S5) Efficiency=80%
Lamps: 1 x Osram Duris S5 (QW PSLPS1.EC) 102lm @ 150mA CCT=6300K P=1.0W I=150mA

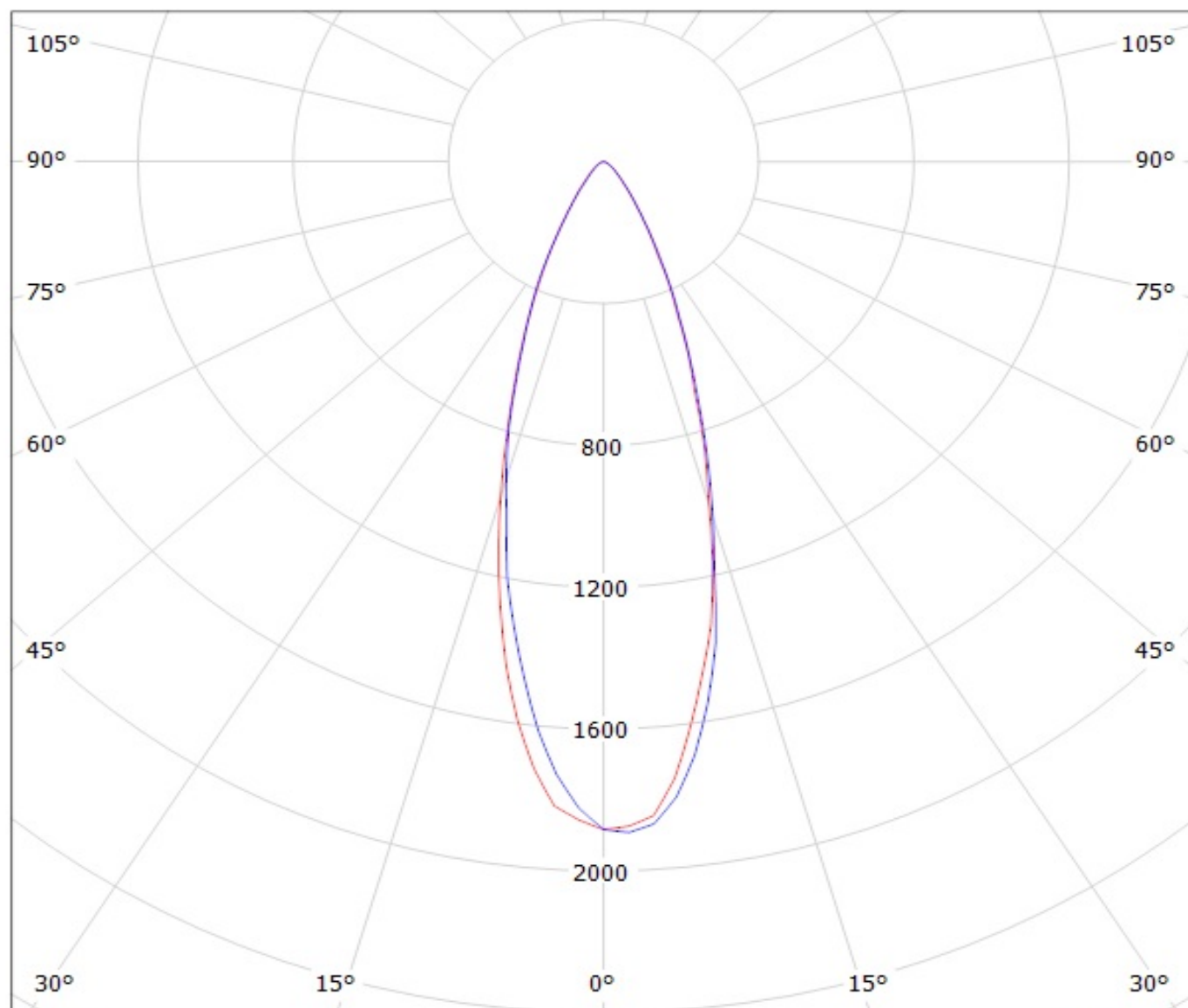

cd/klm

— C0 - C180

— C90 - C270

$\eta = 81\%$

NOTE: The typical divergence will be changed by different color, chip size and chip position tolerance. The typical total divergence is the full angle measured where the luminous intensity is half of the peak value.