

THIS INFORMATION IS CONFIDENTIAL AND IS DISCLOSED TO YOU ON CONDITION THAT NO FURTHER DISCLOSURE IS MADE BY YOU TO OTHER THAN AMP PERSONNEL WITHOUT WRITTEN AUTHORIZATION FROM AMP (TAIWAN) LTD. DIMENSIONS IN MILLIMETERS. DO NOT SCALE PRINT.

PRINT DIST
DW

METRIC

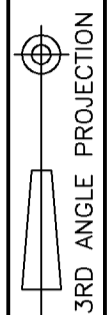

NUMBER
C-1775486

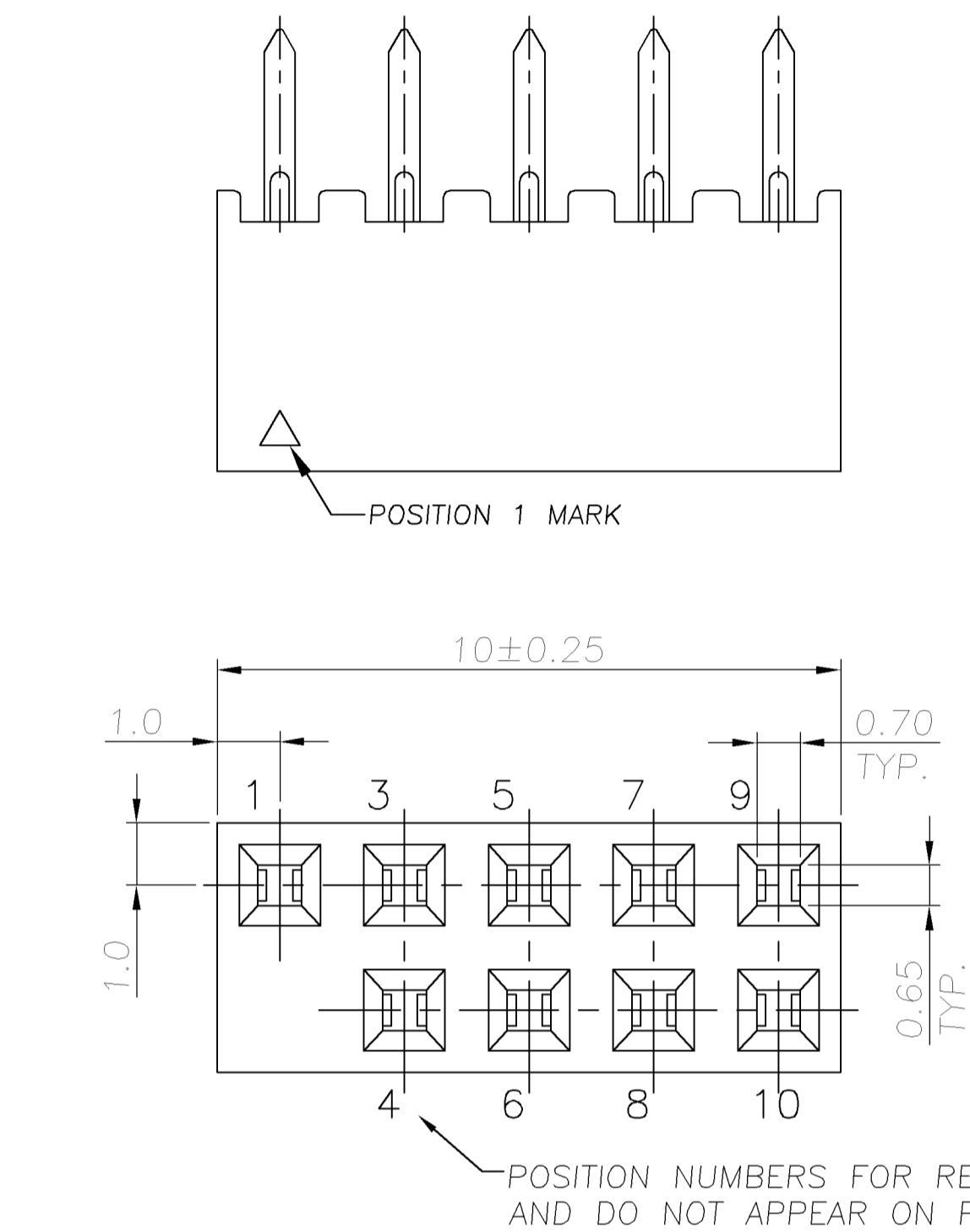

POSITION NUMBERS FOR REFERENCE ONLY AND DO NOT APPEAR ON PART

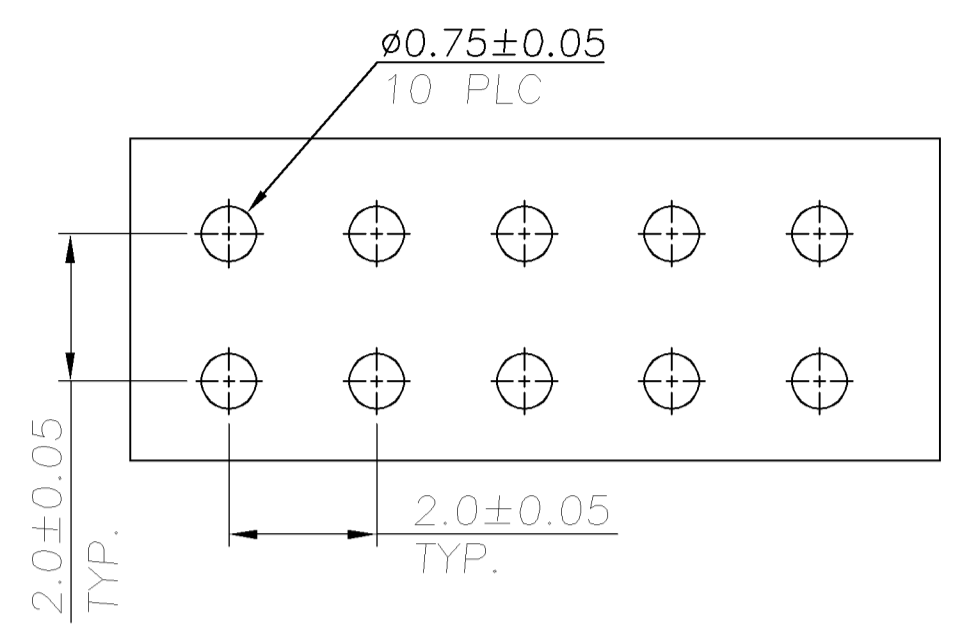
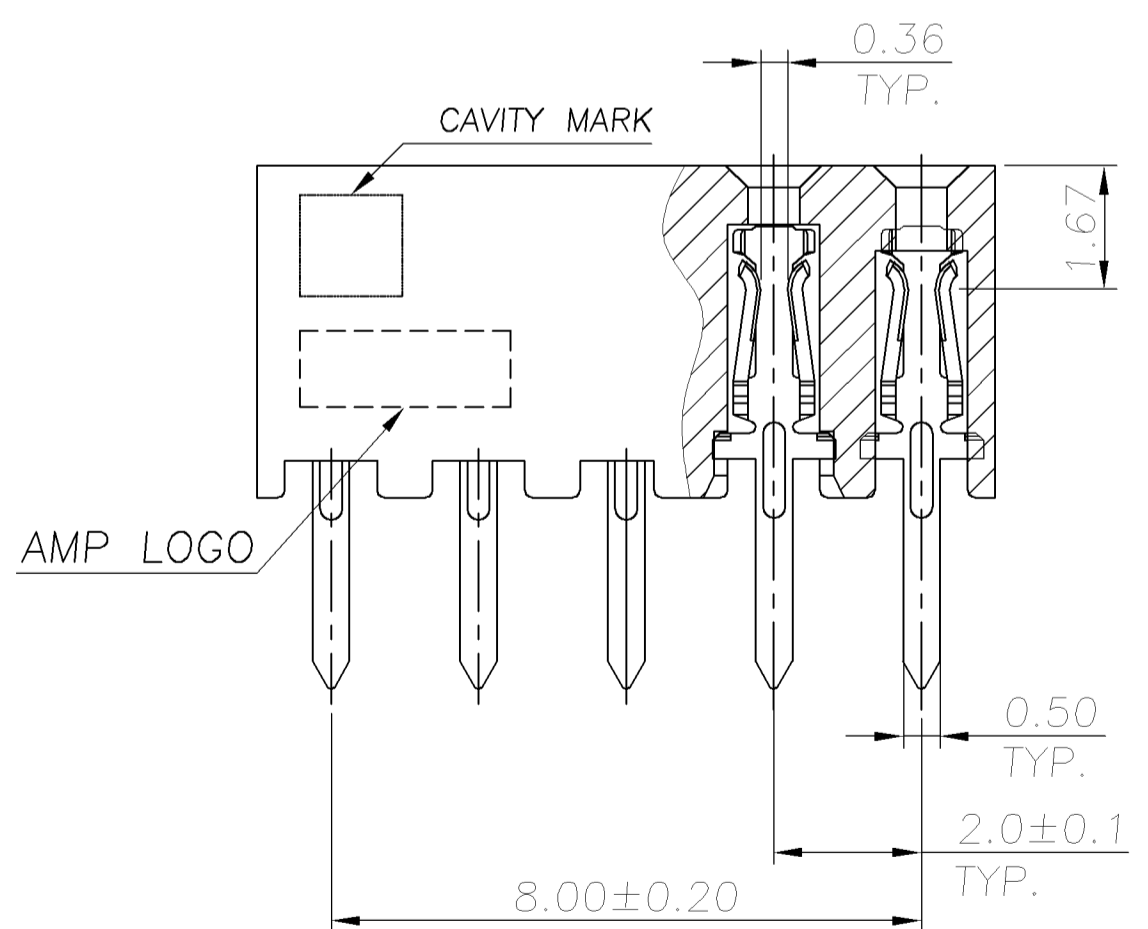

RECOMMENDED PCB LAYOUT

- NOTE:
- MATERIAL :
HOUSING : THERMOPLASTIC, UL94V-0, BLACK COLOR.
CONTACT : PHOSPHOR BRONZE, THICKNESS=0.20mm.
 - FINISH:
CONTACT : 0.2um [8u"] MIN. GOLD PLATED ON CONTACT AREA
2.54um [100u"] MIN. MATTE TIN PLATED ON SOLDERTAILS,
1.27um [50u"] MIN. NICKEL UNDERPLATED OVER ALL
 - APPLICATION :
SOLDERTAIL LENGTH 2.6 FOR PCB THICKNESS 1.6±0.1
 - WAVE SOLDER CAPABLE TO 265°C PER TYCO SPEC 109-202, CONDITION B.

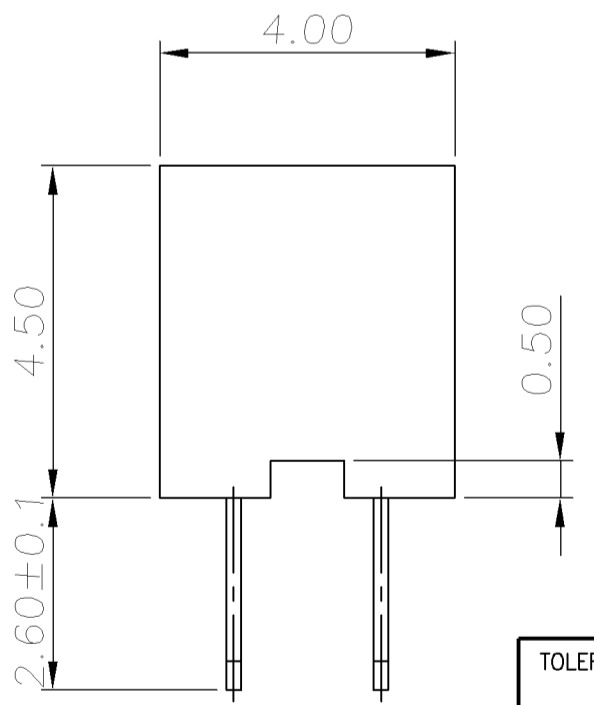

A	FIRST RELEASED		OH SH	30SEP 2006
LTR	REVISION RECORD	ECN	DWN CHK	DATE

TOLERANCES UNLESS OTHERWISE SPECIFIED:		DWN	O. HU
0 PLC	±		26-SEP-2006
1 PLC	±0.15	CHK	S. HOU
2 PLC	±0.10		26-SEP-2006
3 PLC	±0.05		
ANGLES ±3°			
MATERIAL		APVD	W.J. KE
SEE NOTE			26-SEP-2006
FINISH		PRODUCT SPEC	
SEE NOTE		108-57197	
		QUALIFICATION TEST REPORT	
		501-57197	
		WEIGHT	

2	10	1-1775486-0
KEYING POS.	POS	PART NUMBER
tyco TYCO HOLDINGS (BERMUDA) Electronics VII LTD. TAIWAN BRANCH		
NAME		
AMPMODU 2.0MM PITCH, RCPT VERTICAL, OMITTED PIN		
LOC	SIZE	DRAWING NO
DW	A ₃	C-1775486
SCALE		REV A
		SHEET
	--	1 OF 2

NUMBER
C-1775486

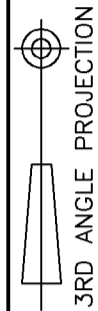

METRIC

THIS INFORMATION IS CONFIDENTIAL AND IS DISCLOSED TO YOU ON CONDITION THAT NO FURTHER DISCLOSURE IS MADE BY YOU TO OTHER THAN AMP PERSONNEL WITHOUT WRITTEN AUTHORIZATION FROM AMP (TAIWAN) LTD. DIMENSIONS IN MILLIMETERS. DO NOT SCALE PRINT.

PRINT
DW

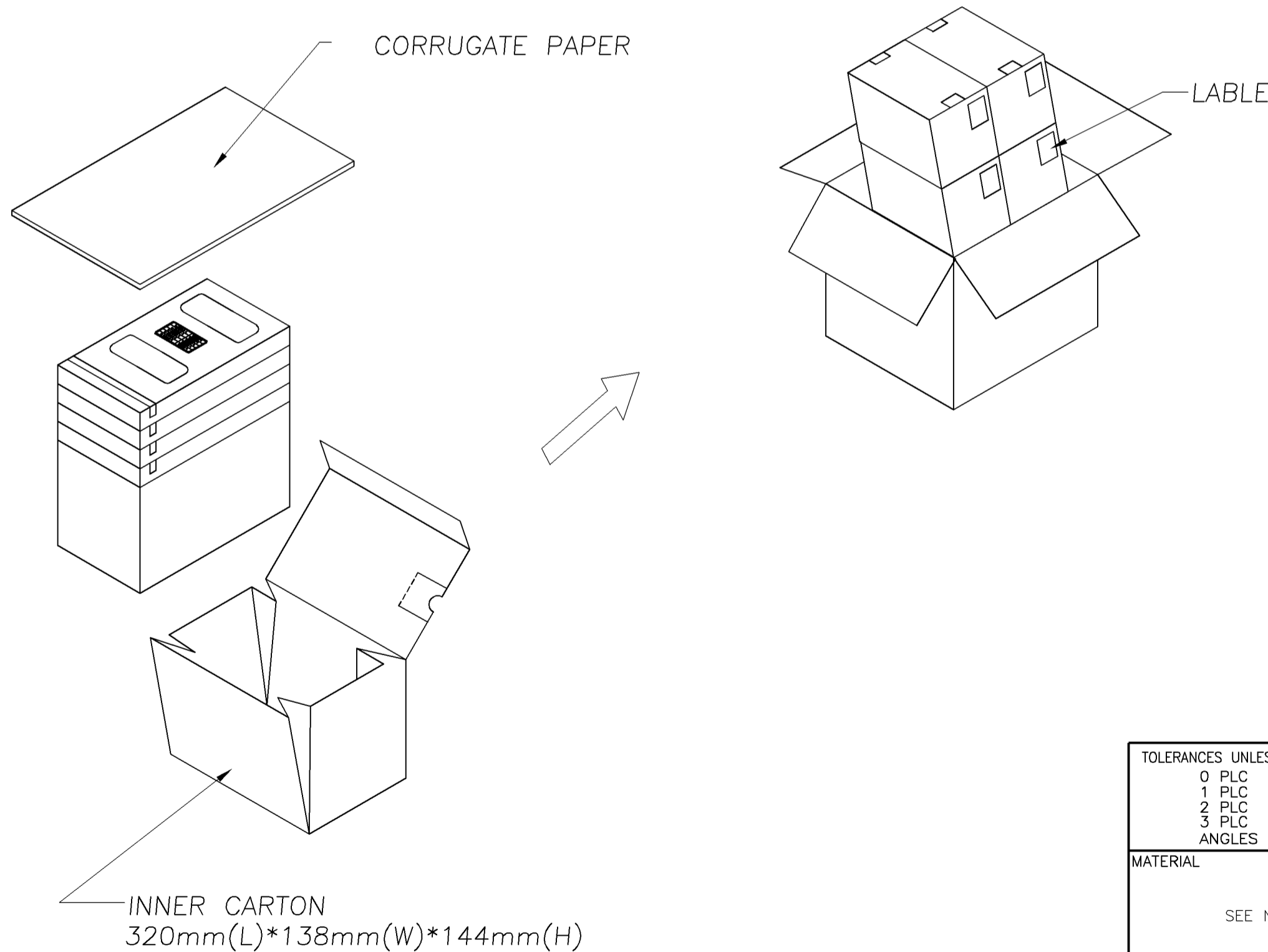
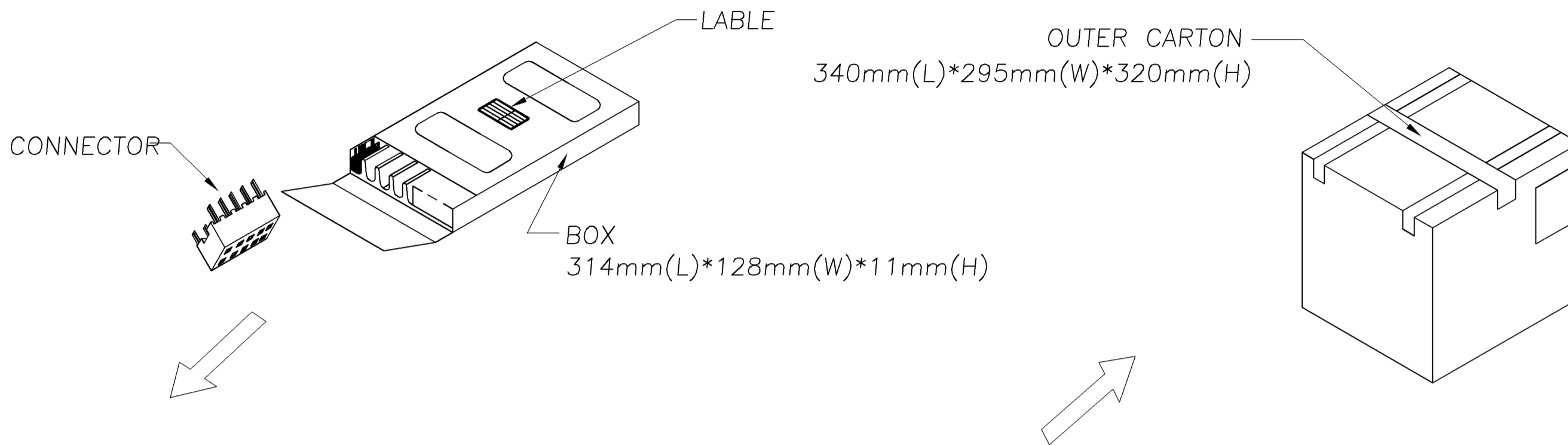

SEE SHEET 1.	ECN	DWN	CHK	DATE
LTR	REVISION RECORD			

20880	4	12	435	10	1-1775486-0
TOTAL	INNER CARTON/ OUTER CARTON	BOX/INNER CARTON	PCS/BOX	POS	PART NUMBER

TOLERANCES UNLESS OTHERWISE SPECIFIED: 0 PLC ± 1 PLC ± 2 PLC ± 3 PLC ± ANGLES ±	DWN	O. HU 26-SEP-2006	tyco TYCO HOLDINGS (BERMUDA) Electronics VII LTD. TAIWAN BRANCH NAME		
	CHK	S. HOU 26-SEP-2006			
MATERIAL SEE NOTE	APVD	W.J. KE 26-SEP-2006	AMPMODU 2.0MM PITCH, RCPT VERTICAL, OMITTED PIN		
	PRODUCT SPEC	--			
FINISH SEE NOTE	QUALIFICATION TEST REPORT	--	LOC	SIZE	DRAWING NO
	WEIGHT	--	DW	A ₃	C-1775486
			SCALE	--	REV A
			SHEET		2 OF 2

8 7 6 5 4 3 2 1 CUSTOMER DRAWING

D
C
B
A